



US Army Corps
of Engineers®

General Investigation Research and Development Program

Flood-Fighting Structures Demonstration and Evaluation Program: Laboratory and Field Testing in Vicksburg, Mississippi

Fred Pinkard, Thad Pratt, Donald Ward
Tina Holmes, Julie Kelley, Landris T. Lee,
George Sills, Eric Smith, Perry A. Taylor,
Nalini Torres, Lillian Wakeley, and Johannes Wibowo

July 2007



Flood-Fighting Structures Demonstration and Evaluation Program: Laboratory and Field Testing in Vicksburg, Mississippi

Fred Pinkard, Thad Pratt, Donald Ward

*Coastal and Hydraulics Laboratory
U.S. Army Engineer Research and Development Center
3909 Halls Ferry Road
Vicksburg, MS 39180-6199*

Tina Holmes, Julie Kelley, Landris T. Lee, George Sills, Eric Smith, Perry A. Taylor, Nalini Torres,
Lillian Wakeley, Johannes Wibowo

*Geotechnical and Structures Laboratory
U.S. Army Engineer Research and Development Center
3909 Halls Ferry Road
Vicksburg, MS 39180-6199*

Final report

Approved for public release; distribution is unlimited.

ABSTRACT: Within the United States, sandbags have traditionally been the product of choice for temporary, barrier type flood-fighting structures. However, sandbag structures are labor intensive and time consuming to construct. Therefore, a need exists for more expedient, cost effective, temporary barrier type flood-fighting technologies. In 2004, Congress directed the U.S. Army Corps of Engineers to devise real-world testing procedures for Rapid Deployment Flood Wall (RDFW) and other promising alternative flood-fighting technologies. In response to that directive, the U.S. Army Engineer Research and Development Center (ERDC) developed a comprehensive laboratory and field-testing program for RDFW and two other flood-fighting products. Those two products, Portadam and Hesco Bastion, were selected on technical merit from proposals submitted by companies who manufacture temporary, barrier type flood-fight products. A standard sandbag structure was also tested in both the laboratory and field to provide a baseline by which the other products could be evaluated.

During 2004, laboratory and field testing was conducted in Vicksburg, MS, under stringent testing protocols. The lab testing was conducted in a modified wave basin at ERDC. The field testing was conducted at the Vicksburg Harbor. The lab and field protocols included both performance parameters and operational parameters. These tests will provide the flood-fighting community results that will assist in the selection of the product that best fits their temporary, barrier type flood-fighting needs.

DISCLAIMER: The contents of this report are not to be used for advertising, publication, or promotional purposes. Citation of trade names does not constitute an official endorsement or approval of the use of such commercial products. All product names and trademarks cited are the property of their respective owners. The findings of this report are not to be construed as an official Department of the Army position unless so designated by other authorized documents.

DESTROY THIS REPORT WHEN IT IS NO LONGER NEEDED. DO NOT RETURN TO THE ORIGINATOR.

Contents

| | |
|--|--------|
| Conversion Factors, Non-SI to SI Units of Measurement | xxiii |
| Preface | xxiv |
| Executive Summary | xxvi |
| Introduction | xxvi |
| Laboratory Testing | xxvii |
| Laboratory Testing - Results | xxvii |
| Field Testing | xxviii |
| Field Testing - Results | xxvix |
| Product Costs | xxx |
| Product Summaries | xxxii |
| Acronyms and Abbreviations | xxxii |
| 1—Introduction | 1 |
| Introduction | 1 |
| Background | 1 |
| Project authority | 1 |
| Report format | 2 |
| Scope of Work | 2 |
| Project description | 2 |
| Laboratory testing | 3 |
| Construction | 4 |
| Engineering | 5 |
| Environmental | 5 |
| Product Selection Criteria and Process | 5 |
| 2—Laboratory Testing and Evaluation of Expedient Flood-Fighting Barriers | 9 |
| Introduction | 9 |
| Experiment Overview | 9 |
| Testing Equipment and Procedure | 10 |
| Test facility layout and construction | 10 |
| Test facility instrumentation | 13 |
| Testing protocol | 25 |

| | |
|--|---------|
| USACE Sandbag Levee Tests | 27 |
| Design | 27 |
| Construction..... | 31 |
| Performance | 34 |
| Hydrostatic head tests | 34 |
| Hydrodynamic tests | 37 |
| Debris impact test | 43 |
| Levee-overtopping test | 44 |
| Maintenance and repair..... | 48 |
| Disassembly and reusability | 49 |
| Environmental aspects | 50 |
| Hesco Bastion Concertainer Levee Tests | 50 |
| Design | 50 |
| Construction..... | 51 |
| Performance | 61 |
| Hydrostatic head tests | 62 |
| Hydrodynamic tests | 62 |
| Levee-overtopping test | 72 |
| Debris impact test | 74 |
| Maintenance and repair..... | 75 |
| Disassembly and reusability | 77 |
| Environmental aspects | 81 |
| RDFW Levee Tests | 82 |
| Design | 82 |
| Construction..... | 83 |
| Performance | 98 |
| Hydrostatic head tests | 98 |
| Hydrodynamic tests | 105 |
| Levee overtopping test..... | 115 |
| Debris impact test | 116 |
| Maintenance and repair..... | 116 |
| Disassembly and reusability | 116 |
| Environmental aspect..... | 127 |
| Portadam Levee Tests | 132 |
| Design | 132 |
| Construction..... | 132 |
| Performance | 148 |
| Hydrostatic head tests | 148 |
| Hydrodynamic tests | 152 |
| Levee overtopping test..... | 160 |
| Debris impact test | 162 |
| Maintenance and repair..... | 162 |
| Disassembly and reusability | 165 |
| Environmental aspects | 170 |
| Summary and Conclusions from Laboratory Tests | 170 |
| Caution about product selection..... | 170 |
| Summary of laboratory tests | 170 |
| 3—Site Selection, Characterization, Instrumentation, and Field Testing | 175 |
| Selection Criteria for Field Test Site | 175 |

| | |
|---|---------|
| Required Activities and Limitations for Field Demonstrations..... | 176 |
| Characterization of Field Demonstration Site | 176 |
| Test site location | 176 |
| Geologic setting | 177 |
| Methods and results | 179 |
| Conclusions..... | 182 |
| Field Test Instrumentation..... | 183 |
| Introduction..... | 183 |
| Video monitoring..... | 184 |
| Water level monitoring | 188 |
| Structure dimension monitoring | 193 |
| Results..... | 198 |
| Field Installation and Performance of Sandbag Barrier | 202 |
| Introduction..... | 202 |
| Filling..... | 202 |
| Field construction | 203 |
| Testing | 207 |
| Removal | 210 |
| Reusability | 212 |
| Summary | 212 |
| Field Installation and Performance of Hesco Bastion Concertainer..... | 214 |
| Introduction..... | 214 |
| Field construction | 215 |
| Testing | 219 |
| Removal | 223 |
| Reusability | 227 |
| Summary | 229 |
| Field Installation and Performance of Rapid Deployment Flood Wall | 231 |
| Introduction..... | 231 |
| Field construction | 231 |
| Testing | 235 |
| Removal | 238 |
| Reusability | 242 |
| Summary | 242 |
| Field Installation and Performance of Portadam Barrier..... | 245 |
| Introduction..... | 245 |
| Field construction | 245 |
| Testing | 250 |
| Removal | 257 |
| Reusability | 259 |
| Summary | 262 |
| 4—Summary and Conclusions | 265 |
| Summary | 265 |
| Laboratory and field-testing summary..... | 266 |
| Costs | 266 |
| Conclusions | 271 |
| References..... | 274 |

| | |
|--|----|
| Appendix A: Congressional Mandate and Appropriation..... | A1 |
| Appendix B: Project Management Plan | B1 |
| Appendix C: Lab Testing Protocol | C1 |
| Report Documentation Page | |

List of Figures

| | | |
|--------------|---|----|
| Figure 2-1. | Layout of laboratory test facility | 11 |
| Figure 2-2. | Sump pit containing two 4-in. pumps..... | 12 |
| Figure 2-3. | Pumping system used for overtopping, 12-in.-diam..... | 13 |
| Figure 2-4. | Laboratory setup..... | 14 |
| Figure 2-5. | Seepage and displacement data retrieved by data acquisition system..... | 15 |
| Figure 2-6. | Sump pit outflow pipes and flow meters | 15 |
| Figure 2-7. | Lasers and laser targets..... | 16 |
| Figure 2-7a. | Lasers and their targets on levee | 17 |
| Figure 2-7b. | Displacement data from laser 0 | 18 |
| Figure 2-7c. | Displacement data from laser 1 | 19 |
| Figure 2-7d. | Displacement data from laser 2 | 19 |
| Figure 2-7e. | Displacement data from laser 3 | 20 |
| Figure 2-7f. | Displacement data from laser 4 | 20 |
| Figure 2-7g. | Displacement data from laser 5 | 21 |
| Figure 2-7h. | Displacement data from laser 6 | 21 |
| Figure 2-7i. | Displacement data from laser 7 | 22 |
| Figure 2-8. | Relative movement and video monitoring system | 22 |
| Figure 2-9. | Debris impact test setup..... | 23 |
| Figure 2-10. | Reservoir-filling system | 24 |
| Figure 2-11. | Pool level equipment | 24 |
| Figure 2-12. | Wave generator and equipment..... | 25 |
| Figure 2-13. | Separate wave conductivity rod, coordinating waves with seepage..... | 26 |
| Figure 2-14. | USACE Seattle District standard sandbag levee design | 28 |

| | | |
|--------------|--|----|
| Figure 2-15. | Hogan Manufacturing sandbag filling machine used to build 2002 sandbag levee..... | 28 |
| Figure 2-16. | Walla Walla District standard sandbag levee design | 29 |
| Figure 2-17. | Walla Walla and Seattle Districts’ design for placing sandbags..... | 30 |
| Figure 2-18. | 2002 levee, as-built | 30 |
| Figure 2-19. | Sandbagging operation..... | 32 |
| Figure 2-20. | Gradation of sand used for filling sandbags..... | 33 |
| Figure 2-21. | Lap stacking sandbags during construction | 33 |
| Figure 2-22. | Complete sandbag levee with partial construction crew..... | 34 |
| Figure 2-23. | Sandbag levee with three of eight targets ready to test..... | 35 |
| Figure 2-24. | Seepage per linear foot at 1-ft head and under static conditions... | 36 |
| Figure 2-25. | Seepage per linear foot at 2-ft head and under static conditions... | 36 |
| Figure 2-26. | Seepage per linear foot at 32.4 in. (95% H) of head and under static conditions | 37 |
| Figure 2-27. | Damage done during calibration of wave machine..... | 38 |
| Figure 2-28. | Sandbag levee after repair..... | 39 |
| Figure 2-29. | Seepage with dynamic testing at 66 percent levee height and 3-in. waves for 7 hr | 39 |
| Figure 2-30. | Seepage with dynamic testing at 66 percent levee height and 7- to 9-in. waves..... | 40 |
| Figure 2-31. | Seepage with dynamic testing at 66 percent levee height and 10- to 13-in. waves..... | 41 |
| Figure 2-32. | Seepage with dynamic testing at 80 percent levee height and 3-in. waves for 7 hr | 41 |
| Figure 2-33. | Seepage with dynamic testing at 66 percent levee height and 7- to 9-in. waves..... | 42 |
| Figure 2-34. | Seepage with dynamic testing at 66 percent levee height and 10- to 13-in. waves..... | 43 |
| Figure 2-35. | 12- and 16-in. logs at point of impact | 44 |
| Figure 2-36. | Seepage and overtopping | 45 |
| Figure 2-37. | Sandbag levee prior to overtopping | 45 |
| Figure 2-38. | Sandbag levee progressive failure while testing | 46 |
| Figure 2-39. | Sandbag levee after failure..... | 47 |
| Figure 2-40. | Sandbag levee autopsy after overtopping | 47 |
| Figure 2-41. | Sandbag levee damage and levee after field repair 1 | 48 |
| Figure 2-42. | Damage to levee during 10- to 13-in. waves, water at 80 percent of barrier height..... | 49 |

| | |
|---|----|
| Figure 2-43. Heavy equipment used to disassemble sandbags and waste sandbags..... | 49 |
| Figure 2-44. Hesco Bastion Concertainer basket units, assembled and empty..... | 51 |
| Figure 2-45. Hesco levee layout | 52 |
| Figure 2-46. Training session for Hesco assembly team | 52 |
| Figure 2-47. Expanding and positioning units..... | 53 |
| Figure 2-48. Fastening units together | 54 |
| Figure 2-49. Top view of angled unit at intersection of left and center walls ... | 54 |
| Figure 2-50. Cable ties at joint connections | 55 |
| Figure 2-51. Right concrete wall abutment | 55 |
| Figure 2-52. Securing flaps against concrete floor | 56 |
| Figure 2-53. Filling with sand | 56 |
| Figure 2-54. Shoveling sand into unit..... | 57 |
| Figure 2-55. Leveling and compacting sand within each unit..... | 57 |
| Figure 2-56. Filled with sand, view from left concrete wall abutment..... | 58 |
| Figure 2-57. View from pool side..... | 58 |
| Figure 2-58. Sealing concrete wall abutment with aerosol foam..... | 59 |
| Figure 2-59. Expanded foam at abutment with concrete wall | 60 |
| Figure 2-60. Laser target..... | 61 |
| Figure 2-61. Center wall displacement monitoring system | 61 |
| Figure 2-62. Seepage-flow rate per linear foot at 1-ft pool elevation (33% H)..... | 63 |
| Figure 2-63. View of left wall water saturation..... | 63 |
| Figure 2-64. Close-up of seepage through vertical joint between units | 64 |
| Figure 2-65. Seepage flow rate per linear foot at 2-ft pool elevation (66% H)..... | 64 |
| Figure 2-66. View from front | 65 |
| Figure 2-67. Seepage flow rate per linear foot at 95 percent pool elevation | 65 |
| Figure 2-68. Seepage flow rate per linear foot, small wave at 66 percent pool elevation..... | 66 |
| Figure 2-69. Left wall and center wall intersection | 66 |
| Figure 2-70. Seepage flow rate per linear foot, medium wave at 66 percent pool elevation..... | 67 |
| Figure 2-71. Seepage flow rate per linear foot, high wave at 66 percent pool elevation..... | 67 |
| Figure 2-72. Center wall wave erosion..... | 68 |

| | |
|--|----|
| Figure 2-73. Sand eroded from top of center wall | 68 |
| Figure 2-74. Covering top of wall with tarp to prevent further erosion | 69 |
| Figure 2-75. Securing with cable ties | 69 |
| Figure 2-76. Seepage rate per linear foot, small wave at 80 percent pool elevation..... | 70 |
| Figure 2-77. Seepage at vertical joint and wall base | 70 |
| Figure 2-78. Seepage flow rate per linear foot, medium wave at 80 percent pool elevation..... | 71 |
| Figure 2-79. View of left and center walls | 71 |
| Figure 2-80. Seepage flow rate per linear foot, high wave at 80 percent pool elevation..... | 72 |
| Figure 2-81. Wave overtopping along center wall | 72 |
| Figure 2-82. Seepage flow rate per linear foot during overtopping..... | 73 |
| Figure 2-83. Overtopped levee structure, view from right wall | 73 |
| Figure 2-84. Overtopped levee structure, view from left wall..... | 74 |
| Figure 2-85. Seepage flow rate per linear foot during impact tests | 74 |
| Figure 2-86. Log impact zone on center wall, pool side..... | 75 |
| Figure 2-87. Repair 1, view along right wall..... | 76 |
| Figure 2-88. Added sandbag along left wall..... | 77 |
| Figure 2-89. Cutting cable ties and removing top cover..... | 78 |
| Figure 2-90. Preparing to remove center partition pin..... | 78 |
| Figure 2-91. Removing center partition pin..... | 79 |
| Figure 2-92. Preparing to pull unit apart | 79 |
| Figure 2-93. Pulling unit apart..... | 80 |
| Figure 2-94. Outer wall removed from one unit on right wall | 80 |
| Figure 2-95. Removing sand pile..... | 81 |
| Figure 2-96. Stacked units ready for reuse | 81 |
| Figure 2-97. RDFW grid unit | 83 |
| Figure 2-98. RDFW levee layout..... | 84 |
| Figure 2-99. Pallet containing grid units | 85 |
| Figure 2-100. Training session..... | 85 |
| Figure 2-101. Removing and preparing to expand a grid unit..... | 86 |
| Figure 2-102. Laying expanded grid unit on floor | 86 |
| Figure 2-103. Connecting two grid units together..... | 87 |
| Figure 2-104. Left concrete wall abutment, viewed from protected side..... | 87 |
| Figure 2-105. Intersection of left and center walls, viewed from protected side | 88 |

| | |
|--|-----|
| Figure 2-106. View of grid unit connection method | 88 |
| Figure 2-107. Connecting right wall to center wall grid cells, viewed from pool side..... | 89 |
| Figure 2-108. Beginning second grid layer from right concrete wall abutment.. | 89 |
| Figure 2-109. Third grid unit layer at right wall and center wall junction, viewed from pool side | 90 |
| Figure 2-110. Top grid layer installed along center wall/left wall buttress as viewed from pool side | 90 |
| Figure 2-111. Installation of toe grid on pool side of right wall | 91 |
| Figure 2-112. Completed grid installation on left wall | 91 |
| Figure 2-113. Begin sand fill on left wall..... | 92 |
| Figure 2-114. Tamping sand into cells along center wall, viewed from pool side..... | 92 |
| Figure 2-115. Mixing cement and sand for placement in toe grid cells | 93 |
| Figure 2-116. Shoveling mixture into left wall toe grid cells..... | 94 |
| Figure 2-117. View of left concrete wall abutment from pool side | 94 |
| Figure 2-118. Completed sand and mixture fill, left concrete wall abutment | 95 |
| Figure 2-119. View of left wall/center wall buttress from pool side..... | 95 |
| Figure 2-120. Completed sand and mixture fill viewed from pool side..... | 96 |
| Figure 2-121. Mixture fill and tamping in center wall toe grid..... | 96 |
| Figure 2-122. Right wall buttress viewed from pool side | 97 |
| Figure 2-123. Right concrete wall abutment completed sand and mixture fill, viewed from pool side | 97 |
| Figure 2-124. Typical laser target installation..... | 98 |
| Figure 2-125. Seepage flow rate per linear foot at 1-ft pool elevation..... | 99 |
| Figure 2-126. View from pool side | 99 |
| Figure 2-127. View from protected side..... | 99 |
| Figure 2-128. View looking down at left wall | 100 |
| Figure 2-129. Seepage flow rate per linear foot at 2-ft pool elevation (66% H) | 101 |
| Figure 2-130. View of seepage under left wall | 101 |
| Figure 2-131. Sand subsidence in outer grid cells along center wall | 102 |
| Figure 2-132. Left concrete wall abutment | 102 |
| Figure 2-133. View from pool side | 103 |
| Figure 2-134. Seepage flow rate per linear foot at 95 percent pool elevation... | 103 |
| Figure 2-135. View of seepage under structure..... | 104 |

| | |
|--|-----|
| Figure 2-136. View looking down left wall | 104 |
| Figure 2-137. Seepage flow rate per linear foot, small wave at 66 percent pool elevation | 105 |
| Figure 2-138. Left wall buttress | 106 |
| Figure 2-139. Right wall buttress | 106 |
| Figure 2-140. Seepage flow rate per linear foot, medium wave at 66 percent pool elevation | 107 |
| Figure 2-141. Wave impact against center wall | 107 |
| Figure 2-142. Seepage flow rate per linear foot, large wave at 66 percent pool elevation | 108 |
| Figure 2-143. Surface erosion from wave action | 108 |
| Figure 2-144. Seepage flow rate per linear foot, small wave at 80 percent pool elevation | 109 |
| Figure 2-145. View immediately after test showing some sand settling on left wall surface..... | 109 |
| Figure 2-146. Seepage flow rate per linear foot at medium wave and 80 percent pool elevation..... | 110 |
| Figure 2-147 Sporadic wave overtopping at intersection of left and center walls | 110 |
| Figure 2-148 Sporadic wave overtopping at intersection of right and center walls | 111 |
| Figure 2-149. Surface erosion on left wall at conclusion of test | 111 |
| Figure 2-150. Close-up of surface erosion on left wall | 112 |
| Figure 2-151. Waves overtopping left wall..... | 112 |
| Figure 2-152. Seepage flow rate per linear foot, high wave at 80 percent pool elevation | 113 |
| Figure 2-153. Waves overtopping center wall | 113 |
| Figure 2-154. Close-up of center wall after test was concluded | 114 |
| Figure 2-155. Close-up at intersection of left and center walls..... | 114 |
| Figure 2-156. Seepage flow rate per linear foot during overtopping | 115 |
| Figure 2-157. Overtopped levee | 115 |
| Figure 2-158. View along left wall..... | 116 |
| Figure 2-159. Eroded sand deposited on floor | 117 |
| Figure 2-160. Impact test setup | 118 |
| Figure 2-161a. Log impact | 118 |
| Figure 2-161b. Bounce-back..... | 119 |
| Figure 2-162. Scooping up eroded sand along toe grid units..... | 119 |

| | | |
|--------------|--|-----|
| Figure 2-163 | Vacuumping sand out of toe grid units..... | 120 |
| Figure 2-164 | Shoveling out sand/cement mixture from toe grid units and pulling out grid..... | 120 |
| Figure 2-165 | Removing toe grid materials..... | 121 |
| Figure 2-166 | Cleaning out remaining toe grid materials..... | 121 |
| Figure 2-167 | Removing sand from top of wall | 122 |
| Figure 2-168 | Removing sand using vacuum cleaner..... | 122 |
| Figure 2-169 | Removing sand using shovels..... | 123 |
| Figure 2-170 | Removed sand from outer grid cells | 123 |
| Figure 2-171 | Loosening grid unit to reduce frictional resistance from sand.... | 124 |
| Figure 2-172 | Pulling grid unit in an upward fashion..... | 124 |
| Figure 2-173 | Loosened grid unit | 125 |
| Figure 2-174 | Loosening attached grid units | 125 |
| Figure 2-175 | Removing grid units from wall..... | 126 |
| Figure 2-176 | Disassembling grid unit for future reuse..... | 126 |
| Figure 2-177 | Reusable grid units ready for cleaning, refolding, and stacking..... | 127 |
| Figure 2-178 | Continuation of sand removal using shovels | 128 |
| Figure 2-179 | Preparing to remove one of second layer grid units | 128 |
| Figure 2-180 | Removing a grid unit | 129 |
| Figure 2-181 | Bottom layer removal assistance provided by small loader..... | 129 |
| Figure 2-182 | Removing grid unit/sand combination..... | 130 |
| Figure 2-183 | Some nonreusable grid units..... | 130 |
| Figure 2-184 | Nonreusable grid units, sand, and sand/cement mixture ready for disposal..... | 131 |
| Figure 2-185 | Portadam levee layout..... | 133 |
| Figure 2-186 | Air temperature monitor | 133 |
| Figure 2-187 | Apron sandbag filling operation | 134 |
| Figure 2-188 | Transporting sandbags | 134 |
| Figure 2-189 | Connection at lower leg of frames | 135 |
| Figure 2-190 | Frame 2 × 6 heel stop..... | 135 |
| Figure 2-191 | Beginning frame installation from right abutment wall..... | 136 |
| Figure 2-192 | Frame installation against heel stop from left abutment wall | 136 |
| Figure 2-193 | Frame bracket | 137 |
| Figure 2-194 | Installing frame at 90-deg corner..... | 138 |

| | |
|--|-----|
| Figure 2-195. Frames at 60-deg corner, front view | 138 |
| Figure 2-196. Completed frame assembly..... | 139 |
| Figure 2-197. Offloaded vinyl tarp sections to begin unrolling operation | 139 |
| Figure 2-198. Unrolling tarp section | 140 |
| Figure 2-199. View of sandbags placed between each frame opening | 140 |
| Figure 2-200. Hairpin cotter for securing two vinyl tarp sections together..... | 141 |
| Figure 2-201. Securing two tarp sections together with hairpin cotters | 141 |
| Figure 2-202. Rolling seam | 142 |
| Figure 2-203. Hook and loop fastening seam flap | 142 |
| Figure 2-204. Vinyl tarp seam connection complete..... | 143 |
| Figure 2-205. Pulling vinyl tarp up to frame..... | 143 |
| Figure 2-206. Taping tarp to frame | 144 |
| Figure 2-207. Taping apron to concrete floor and placing sandbags over tape | 144 |
| Figure 2-208. Expandable foam treatment at vinyl tarp apron edge | 145 |
| Figure 2-209. Expandable foam treatment at concrete wall abutment | 145 |
| Figure 2-210. Sandbags and 2 × 4 along concrete wall abutment..... | 146 |
| Figure 2-211. Portadam® levee construction completed | 146 |
| Figure 2-212. Laser target mount | 147 |
| Figure 2-213. Installing one of laser targets..... | 147 |
| Figure 2-214. Pool elevation sensor placed on center apron..... | 148 |
| Figure 2-215. Air bubbles beneath apron | 149 |
| Figure 2-216. Under-apron seepage at 1-ft hydrostatic test | 149 |
| Figure 2-217. Seepage flow rate per linear foot at 1-ft pool elevation (33% H) | 150 |
| Figure 2-218. Seepage flow rate per linear foot at 2-ft pool elevation (66% H) | 150 |
| Figure 2-219. View of right wing from pool side, 2-ft hydrostatic head..... | 151 |
| Figure 2-220. Seepage flow rate per linear foot at 95 percent pool elevation... | 151 |
| Figure 2-221. View of right wing from pool side at 95 percent pool elevation | 152 |
| Figure 2-222. Seepage flow rate per linear foot, small waves at 66 percent pool elevation | 153 |
| Figure 2-223. View of right wall, small waves at 66 percent height..... | 153 |
| Figure 2-224. Seepage flow rate per linear foot, medium wave at 66 percent pool elevation | 154 |

| | |
|---|-----|
| Figure 2-225. Wave action from medium waves at 66 percent height..... | 154 |
| Figure 2-226. Seepage flow rate per linear foot, high wave at 66 percent pool elevation | 155 |
| Figure 2-227. Wave action from high waves at 66 percent height..... | 155 |
| Figure 2-228. Wave action from high waves at 66 percent height, view inside left wall | 156 |
| Figure 2-229. Seepage flow rate per linear foot, low wave at 80 percent pool elevation | 156 |
| Figure 2-230. Aborted wave test showing wave overtopping along left wall..... | 157 |
| Figure 2-231. Seepage flow rate per linear foot, medium waves at 80 percent pool elevation..... | 158 |
| Figure 2-232. 7- to 9-in. wave test showing wave overtopping | 158 |
| Figure 2-233. Seepage flow rate per linear foot, high waves at 80 percent pool elevation | 159 |
| Figure 2-234. 10- to 13-in. wave test showing wave overtopping along center wall (partial view)..... | 159 |
| Figure 2-235. 10- to 13-in. wave test showing wave overtopping along center wall..... | 160 |
| Figure 2-236. Seepage flow rate per linear foot during overtopping | 160 |
| Figure 2-237. View of overtopped left wall..... | 161 |
| Figure 2-238. Center wall overtopping | 162 |
| Figure 2-239. Log impact..... | 163 |
| Figure 2-240. Puncture from small log impact..... | 163 |
| Figure 2-241. Water inflow after large log impact..... | 164 |
| Figure 2-242. View of gash caused by large log | 164 |
| Figure 2-243. Seepage flow rate versus pool elevation..... | 165 |
| Figure 2-244. Removing and restacking periphery sandbags..... | 166 |
| Figure 2-245. Unhooking and separating two vinyl tarp sections | 166 |
| Figure 2-246. Removing vinyl tarp ties from frame..... | 167 |
| Figure 2-247. Removing vinyl tarp section for restacking on pallet..... | 167 |
| Figure 2-248. Removing and restacking frame sandbags..... | 168 |
| Figure 2-249. Disassembling frame brackets with socket wrench | 168 |
| Figure 2-250. Removing top bars for frame removal..... | 169 |
| Figure 2-251. Restacking frames and collecting bracket hardware for site removal..... | 169 |
| Figure 2-252. Labor man-hours for each levee system | 171 |

| | |
|--|-----|
| Figure 2-253. Seepage flow rate comparisons for hydrostatic tests | 172 |
| Figure 2-254. Hydrodynamic wave testing at 66 percent water elevation | 173 |
| Figure 2-255. Hydrodynamic wave testing at 80 percent water elevation | 173 |
| Figure 2-256. Repair labor man-hour comparisons..... | 174 |
| Figure 3-1. Location of field test site at the Vicksburg Harbor..... | 177 |
| Figure 3-2. Abandoned channel area in 1955, previous to turning basin construction | 178 |
| Figure 3-3. Vicksburg Harbor elevation profiles..... | 179 |
| Figure 3-4. EM-31 data with DCP and CPT location..... | 182 |
| Figure 3-5. Flood-control structures in place over geophysical data..... | 184 |
| Figure 3-6. StarDot® 1.2 megapixel net camera..... | 185 |
| Figure 3-7. Example DVR software screen..... | 185 |
| Figure 3-8. Camera layout for construction phase and beginning of test phase | 186 |
| Figure 3-9. Camera layout after sandbag structure was inundated..... | 187 |
| Figure 3-10. Typical dual camera mount | 187 |
| Figure 3-11. Concrete sump with fixed-mount staff gage and capacitance water level sensor | 188 |
| Figure 3-12. Staff gages positioned outside structure for visually monitoring water level changes | 189 |
| Figure 3-13. Wave staff water level wiring configuration and dimensions | 190 |
| Figure 3-14. Data acquisition unit packaged inside case..... | 190 |
| Figure 3-15. DAU enclosure enlarged to include battery power supply | 192 |
| Figure 3-16. DAU mounted on an elevated stand | 192 |
| Figure 3-17. RDFW structure dimensions..... | 193 |
| Figure 3-18. RDFW structure side view..... | 194 |
| Figure 3-19. USACE sandbag structure dimensions | 194 |
| Figure 3-20. Sandbag structure viewed from river side | 195 |
| Figure 3-21. Sandbag structure viewed from side..... | 195 |
| Figure 3-22. Hesco structural dimensions | 196 |
| Figure 3-23. Hesco structure side view | 196 |
| Figure 3-24. Hesco structure viewed from river..... | 197 |
| Figure 3-25. Portadam structure dimensions..... | 197 |
| Figure 3-26. Portadam structure viewed from river side..... | 198 |
| Figure 3-27. RDFW seepage data | 199 |
| Figure 3-28. USACE sandbag seepage data..... | 199 |

| | | |
|--------------|---|-----|
| Figure 3-29. | Hesco seepage data | 200 |
| Figure 3-30. | Portadam seepage data | 200 |
| Figure 3-31. | Seepage rate as a function of wetted perimeter area | 201 |
| Figure 3-32. | Seepage rate as function of water elevation | 201 |
| Figure 3-33. | Hogan Automatic-Speed Sandbagger | 203 |
| Figure 3-34. | Unloading from flatbed truck..... | 204 |
| Figure 3-35. | Laying first row of bags | 204 |
| Figure 3-36. | Partially completed riverward face, first row | 205 |
| Figure 3-37. | Placement of second row | 205 |
| Figure 3-38. | Rain water collected inside structure | 205 |
| Figure 3-39. | Water being pumped from structure..... | 205 |
| Figure 3-40. | Area being backdragged to reduce mud..... | 206 |
| Figure 3-41. | Measuring height of structure | 206 |
| Figure 3-42. | Completed 3-ft structure | 206 |
| Figure 3-43. | Required 1-ft raise..... | 206 |
| Figure 3-44. | Completed sandbag structure | 206 |
| Figure 3-45. | 4 June 2004, 1.0 ft of water against structure..... | 207 |
| Figure 3-46. | 5 June 2004, 2.3 ft of water against structure..... | 207 |
| Figure 3-47. | 6 June 2004, 3.3 ft of water against structure..... | 207 |
| Figure 3-48. | 7 June 2004, structure overtopping | 207 |
| Figure 3-49. | 7 June 2004, seepage through structure | 208 |
| Figure 3-50. | 7 June 2004, overtopped structure..... | 208 |
| Figure 3-51. | Sandbag seepage collection tank..... | 208 |
| Figure 3-52. | Seepage through structure | 209 |
| Figure 3-53. | Seepage on protected side | 209 |
| Figure 3-54. | Seepage rates for field test sandbag structure | 209 |
| Figure 3-55. | Attached plastic sheeting to east tieback of sandbag structure..... | 209 |
| Figure 3-56. | Plastic sheeting over riverward face..... | 210 |
| Figure 3-57. | Structure after being submerged | 210 |
| Figure 3-58. | Riverward face | 210 |
| Figure 3-59. | East side of structure | 211 |
| Figure 3-60. | East tieback section | 211 |
| Figure 3-61. | Removal of east tieback section..... | 211 |
| Figure 3-62. | Sandbags removed by front-end loader..... | 211 |

| | | |
|--------------|--|-----|
| Figure 3-63. | Bulldozer piling up sandbags..... | 211 |
| Figure 3-64. | Dozer and front-end loader..... | 211 |
| Figure 3-65. | Disposal site..... | 212 |
| Figure 3-66. | Structure completely removed..... | 212 |
| Figure 3-67. | Hesco Bastion Concertainer as delivered to Vicksburg..... | 215 |
| Figure 3-68. | Hesco Bastion field site prior to construction..... | 215 |
| Figure 3-69. | Hesco Bastion training session..... | 216 |
| Figure 3-70. | Installation of base row units..... | 216 |
| Figure 3-71. | Structure constructed on graded ground and grass/weeds..... | 216 |
| Figure 3-72. | Installation of joint pins..... | 217 |
| Figure 3-73. | Construction of base row tieback section..... | 217 |
| Figure 3-74. | Filling base row with sand..... | 217 |
| Figure 3-75. | Installing top row units..... | 218 |
| Figure 3-76. | Filling top row units with sand..... | 218 |
| Figure 3-77. | Sand fill in top row units..... | 218 |
| Figure 3-78. | Riverward face of completed structure..... | 219 |
| Figure 3-79. | Completed structure from protected side..... | 219 |
| Figure 3-80. | 4 June 2004, no water against structure..... | 220 |
| Figure 3-81. | 5 June 2004, 0.3 ft of water against structure..... | 220 |
| Figure 3-82. | 6 June 2004, 1.3 ft of water against structure..... | 220 |
| Figure 3-83. | 7 June 2004, 2.1 ft of water against structure..... | 220 |
| Figure 3-84. | 8 June 2004, 2.7 ft of water against structure..... | 220 |
| Figure 3-85. | 9 June 2004, 3.1 ft of water against structure..... | 220 |
| Figure 3-86. | 10 June 2004, 3.5 ft of water against structure..... | 221 |
| Figure 3-87. | 11 June 2004, 4.0 ft of water against structure..... | 221 |
| Figure 3-88. | Hesco Bastion seepage collection tank..... | 221 |
| Figure 3-89. | Seepage through joints..... | 222 |
| Figure 3-90. | Seepage on protected side..... | 222 |
| Figure 3-91. | Attaching plastic sheeting to riverward face of Hesco Bastion structure..... | 223 |
| Figure 3-92. | Attempt to reduce seepage using bentonite..... | 224 |
| Figure 3-93. | Removing center connection pins..... | 225 |
| Figure 3-94. | Removing zip ties..... | 225 |
| Figure 3-95. | Removal of top row half units..... | 225 |
| Figure 3-96. | Riverward face of structure..... | 225 |

| | | |
|----------------|---|-----|
| Figure 3-97. | Removal of top row sand | 226 |
| Figure 3-98. | Removal of sand from around base row units | 226 |
| Figure 3-99. | Removal of base row half units | 226 |
| Figure 3-100. | Removal of half units with front end loader | 227 |
| Figure 3-101. | Removal of joint connection pins with front-end loader | 227 |
| Figure 3-102. | Removed units on pallet | 227 |
| Figure 3-103. | Removed units on trailer..... | 227 |
| Figure 3-104. | Units damaged during removal process..... | 228 |
| Figure 3-105. | RDFW as delivered to Vicksburg..... | 232 |
| Figure 3-106. | DFW site back-dragged prior to construction..... | 232 |
| Figure 3-107. | RDFW training session..... | 232 |
| Figure 3-108a. | Unpacking of RDFW units | 232 |
| Figure 3-108b. | Installation of RDFW base row | 232 |
| Figure 3-108c. | Interlocking of RDFW units | 232 |
| Figure 3-109. | Installation of tieback section | 233 |
| Figure 3-110. | Installation of riverward face and tieback section | 233 |
| Figure 3-111. | Stair stepped tieback section..... | 233 |
| Figure 3-112. | Filling of west tieback section units..... | 233 |
| Figure 3-113. | Filling of riverward face and east tieback section units..... | 234 |
| Figure 3-114. | Installation of top row units | 234 |
| Figure 3-115. | Sand fill in completed structure | 234 |
| Figure 3-116. | Riverward face of completed structure | 234 |
| Figure 3-117. | Completed RDFW structure | 235 |
| Figure 3-118. | River level day before testing began, 4 June 2004 | 235 |
| Figure 3-119. | River level at beginning of testing process | 235 |
| Figure 3-120. | Seepage behind RDFW structure..... | 236 |
| Figure 3-121. | Seepage collection in sump tank..... | 236 |
| Figure 3-122. | Fill material washed out of units..... | 236 |
| Figure 3-123. | Shifting of units | 236 |
| Figure 3-124. | Replacing sand washed out or lost from shifted units | 237 |
| Figure 3-125. | Trackhoe replacing sand field..... | 237 |
| Figure 3-126. | Using RDFW unit to contain sand boil..... | 237 |
| Figure 3-127. | Contained sand boil | 237 |
| Figure 3-128. | RDFW structure before overtopping | 238 |
| Figure 3-129. | Overtopping of RDFW structure | 238 |

| | | |
|---------------|---|-----|
| Figure 3-130. | Final overtopping of RDFW structure | 238 |
| Figure 3-131. | Air compressor..... | 239 |
| Figure 3-132. | Hand-held vacuum device (consolidated sand) | 239 |
| Figure 3-133. | Hand-held vacuum device and water hose (saturated sand) | 240 |
| Figure 3-134. | Sand removal from RDFW structure with water hose and compressed air..... | 240 |
| Figure 3-135. | Rented vacuum truck | 240 |
| Figure 3-136. | Shovel used to remove sand..... | 240 |
| Figure 3-137. | Removing sand with shovels | 240 |
| Figure 3-138. | Empty units..... | 240 |
| Figure 3-139. | Vacuumping sand | 241 |
| Figure 3-140. | Removal of sand from truck | 241 |
| Figure 3-141. | RDFW units after removal..... | 241 |
| Figure 3-142. | Removal with backhoe..... | 241 |
| Figure 3-143. | RDFW preparing for shipment | 241 |
| Figure 3-144. | Damaged RDFW unit | 242 |
| Figure 3-145. | Portadam as delivered to Vicksburg | 246 |
| Figure 3-146. | Supporting frame with bolts, clamps, and link bars (hardware)..... | 246 |
| Figure 3-147. | Structure frame constructed on graded and undisturbed ground | 246 |
| Figure 3-148. | Making a 90-degree turn..... | 247 |
| Figure 3-149. | Unrolling liner membrane..... | 248 |
| Figure 3-150. | Seam between liner membrane sections | 248 |
| Figure 3-151. | Liner membrane tied to support frame..... | 248 |
| Figure 3-152. | Excavating trench for liner leading edge | 249 |
| Figure 3-153. | Liner leading edge placed in trench..... | 249 |
| Figure 3-154. | Burying liner leading edge..... | 249 |
| Figure 3-155. | Placing sandbags on liner leading edge | 249 |
| Figure 3-156. | Required Portadam raise | 250 |
| Figure 3-157. | Completed Portadam structure..... | 250 |
| Figure 3-158. | 4 June 2004, no water against structure | 251 |
| Figure 3-159. | 5 June 2004, 0.3 ft of water against structure | 251 |
| Figure 3-160. | 6 June 2004, 1.3 ft of water against structure | 251 |
| Figure 3-161. | 7 June 2004, 2.1 ft of water against structure | 251 |
| Figure 3-162. | 8 June 2004, 2.7 ft of water against structure | 251 |

| | | |
|---------------|--|-----|
| Figure 3-163. | 9 June 2004, 3.1 ft of water against structure | 251 |
| Figure 3-164. | 10 June 2004, 3.5 ft of water against structure | 252 |
| Figure 3-165. | 11 June 2004, structure overtopped | 252 |
| Figure 3-166. | Portadam seepage collection tank..... | 252 |
| Figure 3-167. | Sagging liner | 253 |
| Figure 3-168. | Sagging liner repair (repair 1)..... | 253 |
| Figure 3-169. | Sagging liner repair (repair 2)..... | 254 |
| Figure 3-170. | Typical preparation for overtopping | 254 |
| Figure 3-171. | Reduced protection due to sinking of supporting frame | 255 |
| Figure 3-172. | Sagging of liner between supporting frame members | 255 |
| Figure 3-173. | Stressed liner seam..... | 255 |
| Figure 3-174. | Overtopping of Portadam structure..... | 256 |
| Figure 3-175. | Testing complete..... | 256 |
| Figure 3-176. | Portadam structure after protected side filled with water | 256 |
| Figure 3-177. | Portadam structure prior to removal | 257 |
| Figure 3-178. | Removing liner membrane from supporting frame | 258 |
| Figure 3-179. | Disassembling supporting frame (bolts and clamps) | 258 |
| Figure 3-180. | Disassembling supporting frame | 258 |
| Figure 3-181. | Carrying frame members to staging area | 259 |
| Figure 3-182. | Removal staging area..... | 259 |
| Figure 3-183. | Disconnecting two sections of liner..... | 260 |
| Figure 3-184. | Laborers removing liner from excavated trench | 260 |
| Figure 3-185. | Forklift removing liner from excavated trench | 260 |
| Figure 3-186. | Folding liner..... | 261 |
| Figure 3-187. | Rolling folded liner..... | 261 |
| Figure 3-188. | Liner placed on pallet | 261 |
| Figure 3-189. | Loading Portadam frame members and hardware onto trailer..... | 261 |
| Figure 3-190. | Portadam site with only sandbags remaining..... | 262 |
| Figure 3-191. | Portadam site after removal complete..... | 262 |

List of Tables

| | | |
|-------------|--|--------|
| Table ES-1. | Effort Required to Construct, Repair, and Remove Flood-Fighting Structures | xxvii |
| Table ES-2. | Seepage Rates During Static Head Tests | xxviii |
| Table ES-3. | Structure Damage During Laboratory Testing..... | xxviii |
| Table ES-4. | Effort Required to Construct, Raise 1 ft, and Remove Flood-Fighting Structures | xxix |
| Table ES-5. | Seepage Rates | xxix |
| Table ES-6. | Structure Damage/Reusability During Field Testing | xxx |
| Table ES-7. | Summary of Vendor Furnished Products Costs (March 2004) | xxx |
| Table ES-8. | Summary of USACE Purchased Products Cost (January 2005) | xxx |
| Table ES-9. | Observed Product Strengths and Weaknesses..... | xxxi |
| Table 1-1. | Vendor Proposals..... | 6 |
| Table 2-1. | Summary of Log Impact Damage | 174 |
| Table 2-2. | Summary of Estimated Product Reusability Immediately After Disassembly..... | 174 |
| Table 2-3. | Summary of Environmental Concerns | 174 |
| Table 3-1. | Sandbag Structure Field Testing Summary..... | 213 |
| Table 3-2. | Costs for Sandbag Structure | 214 |
| Table 3-3. | Field Test Seepage Rates – Hesco Bastion | 222 |
| Table 3-4. | Hesco Bastion Damage | 228 |
| Table 3-5. | Hesco Bastion Field Testing Summary..... | 229 |
| Table 3-6. | Costs for Hesco Bastion Concertainer | 230 |
| Table 3-7. | Field Test Seepage Rates – RDFW | 238 |
| Table 3-8. | RDFW Field Testing Summary | 243 |
| Table 3-9. | Costs for RDFW..... | 244 |
| Table 3-10. | Field Test Seepage Rates – Portadam | 253 |
| Table 3-11. | Portadam Field Testing Summary..... | 263 |
| Table 3-12. | Costs for Portadam..... | 264 |
| Table 4-1. | Laboratory Test Summary..... | 268 |
| Table 4-2. | Field Test Summary | 270 |

| | | |
|------------|---|-----|
| Table 4-3. | Cost for Flood-Fighting Products..... | 271 |
| Table B1. | Project Delivery Team | B6 |
| Table B2. | Field and Laboratory Testing Schedule | B12 |
| Table B3. | Required Funding Schedule | B13 |

Conversion Factors, Non-SI to SI Units of Measurement

| Multiply | By | To Obtain |
|-----------------|------------|------------------|
| feet | 0.3048 | meters |
| inches | 0.0254 | meters |
| ounces (mass) | 0.02834952 | kilograms |
| pounds (mass) | 0.45359237 | kilograms |

Preface

This report describes research conducted by the U. S. Army Engineer Research and Development Center (ERDC) through the General Investigation Research and Development (GI R&D) Program for prototype testing of temporary barrier-type flood-fighting structures. The project was funded by the U.S. Army Corps of Engineers (USACE) Flood Control and Coastal Emergency (FCCE) Program and leveraged with the GI R&D technical programs.

In the 2004 Energy and Water Development Bill, Congress directed USACE to develop a comprehensive laboratory and field testing program for the scientific assessment of Rapid Deployment Flood Wall® (RDFW) and “other promising alternative flood-fighting technologies.” This report describes the congressionally mandated testing and evaluation program for three commercial flood-fighting products and sandbags.

Laboratory and field testing were conducted from March to August 2004. The laboratory testing was completed in a wave research basin at ERDC, Vicksburg, MS, and included construction, testing, and removal protocols. Field testing was accomplished at a site north of Vicksburg, on the southern bank of the turning basin of the Vicksburg Harbor.

A Project Delivery Team (PDT) was established to serve for both laboratory and field testing and included a Technical Director, Program Manager, co-Principal Investigators (PI’s), and engineering support staff. In addition, the PDT included advisors from the USACE Districts including the GI R&D Program Product Selection Committee, Emergency Management personnel assigned by Headquarters, USACE (HQUSACE), and local sponsor representatives as recommended by District PDT participants. A complete listing of the Team and their responsibilities can be found in Appendix B within the Project Management Plan.

The ERDC representation on the project development team (PDT) combined the wide range of expertise of the Coastal and Hydraulics Laboratory (CHL) and the Geotechnical and Structures Laboratory (GSL). Dr. Donald Ward (CHL) and Dr. Johannes Wibowo (GSL) led the laboratory testing. Fred Pinkard (CHL) and George Sills (GSL) led the field testing. Other ERDC team members included Perry (Pat) Taylor, Tina Holmes, Landris (Tommy) Lee, Nalini Torres, Eric Smith, Terry Jobe, Lester Flowers, Julie Kelley, Cheri Loden, and Dr. Lillian Wakeley from GSL; Thad Pratt, Thomas Murphy, Calvin Buie, Terry Waller, Christopher Callegan, Mike Kirklin, and Charlie Little from CHL; David Daily from ITL; and Jackie Brown, Kel Shurden, Eddie Stewart, Bill Waldrop, Carl Warner, Paul Williams, and Howard Zeigler from the U.S. Army Engineer District, Vicksburg.

The following authors listed alphabetically wrote sections of the report; Ms. Holmes, Ms. Kelley; Messrs Lee, Pinkard, Pratt, Sills, Smith, and Taylor; Ms. Torres; and

Drs. Wakeley, Ward, and Wibowo. The overall report was assembled and prepared by Messrs. Sills, Taylor, and Pinkard, with assistance from Ms. Kelley. Dr. Wakeley was principal technical reviewer and report coordinator. J. Holley Messing, Coastal Engineering Branch, CHL, formatted this report. Dr. Jack Davis, ERDC Technical Director for Flood and Coastal Storm Damage Reduction, provided a detailed review of the draft report.

Joan Pope, Office Chief of Engineers Program Director for Civil Works and formerly ERDC Technical Director for Flood and Coastal Storm Damage Reduction, provided overall guidance for the project, beginning with the congressional mandate and continuing through PDT selection, planning, technical accomplishment, and reporting. The PDT is grateful to Ms. Pope for providing vision and continuity throughout this many-faceted project.

From CHL, general supervision for this project was provided by James R. Leech, Chief, River Engineering Branch; Dennis Markle, former Chief, Harbors, Entrances, and Structures Branch; Dr. Rose Kress, Chief, Navigation Division; Dr. William D. Martin, Deputy Director, CHL; and Thomas W. Richardson, Director, CHL. From GSL, Dr. Joseph Koester, Chief, Geotechnical and Earthquake Engineering Branch; Dr. Lillian Wakeley, Chief, Engineering Geology and Geophysics Branch; Dr. Robert L. Hall, Chief, Geosciences and Structures Division; and Dr. David Pittman, Director, GSL, provided general supervision.

Dr. James R. Houston was Director of ERDC. COL Richard B. Jenkins was Commander and Executive Director.

Executive Summary

Introduction

Within the United States, sandbags have traditionally been the product of choice for temporary, barrier type flood-fighting structures. Sandbags are readily available and familiar to the general public. However, sandbag structures are labor intensive and time consuming to construct. The U.S. Army Corps of Engineers (USACE) has long been aware of the need to develop more expedient, cost-effective, temporary flood-fighting technologies. Therefore, the USACE continues to encourage the development of innovative products to decrease long-term costs and increase the effectiveness of flood fighting.

In the 2004 Energy and Water Development bill, Congress recognized the need for expedient, temporary barrier type flood-fighting technology. The U. S. Army Engineer Research and Development Center (ERDC) was directed to develop real-world testing procedures for Rapid Deployment Flood Wall (RDFW) and other promising alternative flood-fighting technologies. In response to that directive, ERDC developed a comprehensive laboratory and field testing program for the scientific evaluation of the products.

Three commercially available flood-fighting products plus sandbags were tested in the laboratory and at the Vicksburg Harbor field site in Vicksburg, MS. Rapid Deployment Flood Wall (RDFW) was tested due to the congressional directive. RDFW is granular filled, plastic grid units that connect together with both horizontal and vertical tabs to form a continuous structure. Each RDFW unit is 4 ft long by 4 ft wide by 8 in. high. Sandbags were tested since they are the standard temporary barrier type flood-fighting product used by the Corps of Engineers. The two “other promising alternative technologies” were selected through a competitive process based on technical merit. An advertisement was placed on the FedBizOpps Web page requesting technical proposals for temporary, barrier type flood-fighting products. As a result of the advertisement, nine proposals were received. A five-member team, consisting of hydraulic, geotechnical, and emergency management disciplines, evaluated the proposals against a set of technical criteria developed prior to issuing the advertisement. Final selection of the alternative technologies was made by the evaluation team and then approved by the study Project Delivery Team (PDT). Based on the technical evaluation, Portadam and Hesco Bastion Concertainers® were selected as the products that provided the best overall combination of technical soundness, operational functionality, and economic feasibility. Portadam consists of an impermeable membrane liner that is supported by a steel frame. Hesco Bastion Concertainers are granular-filled, membrane-lined wire baskets that are pinned together to form a continuous structure.

Laboratory Testing

Laboratory testing of Portadam, Hesco Bastion Concertainer, RDFW, and sandbag structures was conducted in a wave research basin at ERDC. The products were tested in a controlled laboratory setting, but under conditions that emulate real-world flood fighting. The structures were tested consecutively under identical conditions. Stringent construction, testing, and removal protocols were developed for the laboratory. The protocol for the laboratory testing included both performance parameters (hydrostatic testing, hydrodynamic testing with waves and overtopping, and structural debris impact testing with a floating log) and laboratory setting operational parameters (time, manpower, and equipment to construct and disassemble, suitability for construction and disassembly by unskilled labor, fill requirements, ability to construct around corners, disposal of fill material, damage, repair, and reusability).

The laboratory testing included the construction of skewed u-shaped structures. The length of the structures varied from approximately 69 ft to about 81 ft. Due to the restrictive height of the research basin walls, the height of each structure was limited to approximately 3 ft. Laboratory testing of the structures was initiated in March 2004 and completed during August 2004. The sandbag structure was tested first in the laboratory followed in order by the Hesco Bastion Concertainer structure, the RDFW structure, and finally, the Portadam structure.

Laboratory Testing – Results

Tables ES-1 through ES-3 present the pertinent laboratory testing results. The results show that the sandbag structure took much longer (205.1 man-hours) to construct than the other three structures. The RDFW structure was the most difficult to remove taking more than three times longer (42 man-hours) than any of the other structures. The laboratory results also show that the RDFW structure had the lowest seepage rates while the Hesco Bastion structure had much higher seepage rates than the other three structures. Table ES-2 includes seepage rates for 1 ft, 2 ft, and 95 percent head. The 1-ft head means that a 1-ft-deep static pool was against the structure during testing. The 2-ft head included a 2-ft-deep static pool against the structure while the 95 percent head included a static pool depth that was equal to 95 percent of the structure height. Each structure sustained varying degrees of damage during testing. This damage is summarized in Table ES-3.

| Table ES-1 Effort Required to Construct, Repair, and Remove the Flood-Fighting Structures | | | |
|--|-------------------------------------|--------------------------------|--------------------------------|
| Structure | Construction (man-hours) | Repairs (man-hours) | Removal (man-hours) |
| Sandbags | 205.1 | 6.0 | 9.0 |
| Hesco Bastion | 20.8 | 1.8 | 13.4 |
| RDFW | 32.8 | 4.6 | 42.0 |
| Portadam | 24.4 | 2.0 | 4.4 |

| Table ES-2 Seepage Rates During Static Head Tests | | | | |
|---|-------------------------------|-------------------------------|---|-----------------------------|
| Structure | 1-ft Head (gpm/ft) | 2-ft Head (gpm/ft) | 95 Percent Head (gpm/ft) | Average (gpm/ft) |
| Sandbags | 0.05 | 0.23 | 0.54 | 0.27 |
| Hesco Bastion | 0.39 | 0.94 | 1.81 | 1.05 |
| RDFW | 0.02 | 0.08 | 0.10 | 0.07 |
| Portadam | 0.10 | 0.14 | 0.14 | 0.13 |
| Note: gpm/ft = gallons per minute per linear foot of structure. | | | | |

| Table ES-3 Structure Damage During Laboratory Testing | |
|--|---|
| Structure | Observed Damage |
| Sandbags | Repeatedly damaged by waves Failed during overtopping |
| Hesco Bastion | Minor sand settling and washout Some bending of wire during debris impact |
| RDFW | Minor sand settling Significant washout along edges and toe Toe damaged during large waves or overtopping 10 percent of structure broken |
| Portadam | Impermeable liner torn during debris impact |

Field Testing

During May 2004, Portadam, Hesco Bastion Concertainer, RDFW, and sandbag structures were constructed at a field site at the Vicksburg Harbor. Each structure was generally u-shaped with an approximately 100-ft riverward face. The structures were originally constructed high enough to hold back 3 ft of water. Each structure was then required to be raised high enough to hold back 4 ft of water to demonstrate that the structures could be raised if used in a situation where floodwaters continue to rise.

The Vicksburg Harbor site is within the backwater area of the Mississippi River, which insures relatively reliable, predictable water levels. Soil conditions indicated that the Vicksburg Harbor site contained suitable substrate that was consistent over a sufficiently large area. The field test site is located on Government property, requiring no rights of entry or easements and security was already provided. The site is also adjacent to the U. S. Army Engineer District, Vicksburg Mat Sinking Unit where a large, available labor force and heavy construction equipment were available to construct the four test structures. The structures were constructed on individually prepared sites. The specific site on which each structure was constructed was determined by a random drawing.

By the first week of June 2004, water levels were sufficient to begin testing. Unlike the laboratory testing, the four structures were tested at the field site concurrently. As the water levels rose, seepage was determined for each structure by collecting the seepage water in a concrete tank on the protected side of each structure. The seepage rates were calculated by determining the change in volume in the collection tank over time. Testing

continued until the structures overtopped. By July 2004, the water levels had receded enough that the structures were removed. The structures in the field were constructed, tested, and removed in accordance with established protocols.

The field testing allowed a complete assessment of operational concerns such as construction right of way requirements, adaptability to varying terrain, ease of construction and removal (time, manpower, equipment) seepage, fill requirements, repair, reusability, and ability to raise.

Field Testing - Results

Tables ES-4 through ES-6 present the pertinent field testing results. The results show that the sandbag structure was time consuming to construct, requiring much longer time than the other three structures. Table ES-4 includes the time to construct each structure to its initial height to hold back 3 ft of water. The effort to raise included the time to increase the height of each structure to hold back 4 ft of water. As occurred in the lab testing, the RDFW structure took much longer to remove and the Hesco Bastion structure had much higher seepage rates. The seepage rates in Table ES-5 are based on a wetted area of the structure. Wetted area was used since the ground elevations at the base of the structures varied. Therefore, for a given river stage, each structure would have a different height of water against it. All three of the vendor products performed well during the field testing with all three having high rates of reusability (Table ES-6).

| Table ES-4 Effort Required to Construct, Raise, and Remove the Flood-Fighting Structures | | | |
|---|-------------------------------------|------------------------------|--------------------------------|
| Structure | Construction (man-hours) | Raise (man-hours) | Removal (man-hours) |
| Sandbags | 419.8 | 33.3 | 3.5 |
| Hesco Bastion | 34.7 | 22.8 | 36.3 |
| RDFW | 39.4 | 9.0 | 113.4 |
| Portadam | 25.6 | 0.6 | 12.6 |

| Table ES-5 Seepage Rates | | | | |
|---|------------------------------|----------------------|-------------|-----------------|
| Wetted Area of Structure (sq ft) | Seepage Rate (gal/hr) | | | |
| | Sandbags | Hesco Bastion | RDFW | Portadam |
| 100 | 0 | 300 | 50 | 200 |
| 200 | 0 | 2300 | 200 | 300 |
| 300 | 50 | 3900 | 700 | 500 |
| 400 | 300 | 6000 | 900 | 550 |
| 500 | 800 | --- | 1500 | 600 |
| 600 | 3200 | --- | --- | 600 |

| Table ES-6 Structure Damage / Reusability During Field Testing | |
|---|--|
| Structure | Observed Damage |
| Sandbags | Began to deteriorate (bags not to specs) All disposed |
| Hesco Bastion | Bent some panels and coils during removal Over 95 percent reusable |
| RDFW | Broke some pieces during testing and removal Over 90 percent of pieces reusable |
| Portadam | None – 100 percent reusable |

Product Costs

Even if a product performs well, the flood-fighting community is not likely to use the product unless it is cost-effective. In order to make a fair comparison of costs, each product vendor was asked to provide the cost of constructing and removing 1,000 linear ft of their product, 3 ft high in Vicksburg. These costs include purchase of the product, fill material, labor, and equipment rental. The furnished costs show that the cost of the products, especially for the RDFW and Portadam products far outweigh the combined cost of the fill material, labor, and equipment rental. Table ES-7 provides a summary of the vendor furnished product cost. During January 2005, the Corps purchased approximately 5,000 lft, 4 ft high of each of the products. These products were purchased for pilot testing and to be stored and made available during real-world floods to any Corps District that chooses to use them. Table ES-8 provides a summary of the cost of those products.

| Table ES-7 Summary of Vendor Furnished Products Cost (March 2004) | | | |
|--|---|---------------------|-------------------------------------|
| Product | Product Description | Product Cost | Product Cost Per Linear Foot |
| Hesco Bastion | 67 3'x3'x15' units at \$394/unit (1005 feet) | \$26,398 | \$26.27 |
| RDFW | 1,450 4'x4'x8" units at \$95/unit (1015 feet) | \$137,750 | \$135.71 |
| Portadam | 3' high frames, liner, hardware | \$71,300 | \$71.30 |

| Table ES-8 Summary of USACE Purchased Products Cost (January 2005) | | | |
|---|--|---------------------|-------------------------------------|
| Product | Product Description | Product Cost | Product Cost Per Linear Foot |
| Hesco Bastion | 336 4'x3'x15' units at \$488/unit (5,040 ft) | \$163,968 | \$32.53 |
| RDFW | 8,700 4'x4'x8" units at \$95/unit (5,075 ft) | \$826,500 | \$162.86 |
| Portadam | 4' high frames, liner, hardware | \$473,595 | \$94.72 |

Product Summaries

The lab and field testing conducted during 2004 revealed several product strengths and weaknesses. These are presented in Table ES-9.

| Table ES-9 Observed Product Strengths and Weaknesses | | |
|---|---|---|
| Product | Strengths | Weaknesses |
| Sandbags | <ol style="list-style-type: none"> 1. Low product cost 2. Conforms well to varying terrain 3. Low seepage rates 4. Can be raised if needed | <ol style="list-style-type: none"> 1. Labor intensive and time consuming to construct 2. Not reusable |
| Hesco Bastion | <ol style="list-style-type: none"> 1. Ease of construction / removal (time and manpower) 2. Low product cost 3. Reusable 4. Can be raised if needed | <ol style="list-style-type: none"> 1. Significant right of way required due to granular fill placed with machinery perpendicular to the structure 2. High seepage rates |
| RDFW | <ol style="list-style-type: none"> 1. Ease of construction (time and manpower) 2. Low seepage rates 3. Reusable 4. Can be raised if needed 5. Height flexibility (8-in units) | <ol style="list-style-type: none"> 1. Significant right of way required due to granular fill placed with machinery perpendicular to the structure 2. High product cost 3. Labor intensive and time consuming to remove |
| Portadam | <ol style="list-style-type: none"> 1. Ease of construction / removal (time, manpower, and equipment) 2. Low seepage rates 3. No required fill 4. Reusable 5. Limited total ROW required (footprint + construction work area) | <ol style="list-style-type: none"> 1. Punctured during laboratory debris impact test 2. Cannot be raised in a typical application 3. Not applicable for high wind use without anchoring |

The laboratory and field testing pertinent information has been placed on a publicly accessible Web page to assist locals in the selection of products that best meet their temporary, barrier style flood-fighting needs. The Web site address is <http://chl.erdc.usace.army.mil/ffs>.

Acronyms and Abbreviations

| | |
|------------|---|
| A/D | Analog to Digital |
| AR-Number | Army Regulation Number |
| ASCII | American Standard Code for Information Interchange |
| AVI | Audio Video Interleave |
| CHL | Coastal and Hydraulics Laboratory |
| cu yd | cubic yards |
| deg | degrees |
| diam | diameter |
| DPW | Directorate of Public Works |
| DVR | Digital Video Recording |
| EM | Emergency Management |
| EM-Number | Engineering Manual Number |
| ERDC | U. S. Army Engineer Research and Development Center |
| ERDC-WES | U. S. Army Engineer Research and Development Center – Waterways Experiment Station |
| FCCE | Flood Control and Coastal Emergencies |
| FedBizOpps | Federal Business Opportunities |
| FHSS | Frequency-Hopping Spread System |
| ft | feet |
| GI R&D | General Investigation Research and Development |
| gph | gallons per hour |
| gpm | gallons per minute |
| gpm/ft | gallons per minute per linear foot |
| GSL | Geotechnical and Structural Laboratory |
| GUI | Graphic User Interface |

| | |
|--------------------|---|
| HQ USACE | Headquarters, U.S. Army Corps of Engineers |
| Hr | hours |
| Hz | cycles |
| IEEE | Institute of Electrical and Electronic Engineers |
| in. | inches |
| JPEG | Joint Photographic Experts Group |
| LAN | Local Area Network |
| lft | Linear feet |
| lin. | Linear inches |
| MB | Mega-Bits |
| MC | Micro Controller |
| MHz | Mega-Cycles |
| min | minutes |
| mpbs | Megabits per second |
| mph | miles per hour |
| mW | milli-Watt |
| NGVD | National Geodetic Vertical Datum |
| PDT | Project Delivery Team |
| PI | Principal Investigator |
| PI's | Principal Investigators |
| PMP | Project Management Plan |
| lb/ft ² | pounds per square foot |
| PVC | Polyvinyl Chloride |
| RDFW | Rapid Deployment Flood Wall |
| rpm | revolutions per minute |
| RS232 | Recommended Standard Number 232 |
| sec | seconds |
| SP (Sand) | Uniformly Graded |
| STP | Standard Testing Protocol |
| Towns | Technologies and Innovations for Urban Watershed Networks |
| USACE | U.S. Army Corps of Engineers |
| V | volts |

| | |
|------|---------------------------------------|
| VDC | Volts Direct Current |
| WDAT | Wireless Data Acquisition Transmitter |

1 Introduction

Introduction

Sandbag barriers traditionally have been the method of choice to raise the height of levees and to protect infrastructure from rising floodwaters. Sandbag structures are labor intensive and time consuming to construct. However, sandbags are readily available and are familiar, and therefore acceptable, to the general public. The U.S. Army Corps of Engineers (USACE) has used sandbags routinely in flood fights for decades, during which time the USACE has been aware of the need to find more rapid and still cost-effective methods of constructing temporary flood barriers.

Early in 2004, Congress tasked the U. S. Army Engineer Research and Development Center (ERDC) to “devise real-world testing procedures for ... promising alternative flood-fighting technologies...” This report describes the selection and testing of a temporary, barrier style flood-fighting products in laboratory and field conditions and at prototype scale. The products tested included standard sandbags as well as three commercially available flood-fighting products.

Background

Project authority

ERDC conducted research and developed a laboratory procedure for the prototype testing of temporary barrier-type flood-fighting structures intended to increase levels of protection during floods. The Rapid Deployment Flood Wall (RDFW) is one commercial product example of this type of structure. Per direction from Congress in the Energy and Water Development Bill for 2004:

The Nation deserves the best, most reliable, most economical tools which technology can provide for the protection of its citizenry and their property when confronted with natural disaster. The conferees are aware of the preliminary testing of the Rapid Deployment Flood Wall at the Engineering Research and Development Center in Vicksburg, Mississippi. This technology has shown promise in the effort to fight floods. Its proponent's claim, and preliminary tests tend to confirm, that it can be cost-effective, quick to deploy, and superior to traditional sandbags in protecting property from flood damages totaling millions in dollars each year. The conferees therefore direct the Corps of Engineers, within funds available in the Flood Control and Coastal

Emergencies account, to act immediately to devise real-world testing procedures for this and other promising alternative flood fighting technologies, and to provide a status report to the Committees on Appropriations within 180 days of enactment of this legislation.

(See Appendix A)

To address this congressional directive, ERDC has tested the RDFW and two other flood-fighting technologies using previously developed laboratory test protocol to compare the effectiveness of each product under carefully controlled laboratory test conditions. In addition, controlled field tests were conducted. In both the laboratory and field, a standard sandbag levee was constructed to provide a baseline by which the other products could be compared. This report describes the facilities, test procedures, and results for both the laboratory and field tests.

Report format

This report is divided into four chapters plus appendices. Chapter 1 is an introduction and general description of the project, and describes the selection process by which two “promising alternative flood-fighting products” were selected for testing along with the RDFW. Chapter 2 describes the laboratory portion of the project including description of test facilities, testing protocol, and results. Chapter 3 includes the field testing portion of the project including site selection and characterization, testing, and results. Chapter 4 provides the laboratory and field testing summary and conclusions. Appendix A to the report includes the congressional mandate directing the USACE to perform the work described herein. Appendix B includes the Project Management Plan and lists members of the Project Delivery Team (PDT). Appendix C provides the laboratory testing protocol.

Scope of Work

Project description

A research basin and testing protocols from previous research activities were used to test the flood-fighting products. The draft standardized protocol for prototype-scale laboratory testing of temporary barrier-type flood-fighting products was used, which includes both performance parameters (hydrostatic testing, hydrodynamic testing with waves and overtopping, and structural impact testing with a floating log) and laboratory-setting operational parameters.

For both the laboratory and field testing, quantifiable operational data such as man-hours for construction and disassembly, special equipment requirements, and quantity of fill material were recorded. Representatives from the testing PDT evaluated the test structures for qualitative operational factors such as suitability for construction by unskilled labor, suitability for construction on sloping or uneven ground, susceptibility to end effects or undercutting, long-term durability and repairability, and reasonableness of special equipment or materials when considering use at a remote location. Susceptibility of product materials to puncture or tear and ability to make repairs in the field were evaluated qualitatively. The ability to increase structure height to hold back one additional foot of water after its initial construction was evaluated at the field test site

only. Disposal, reusability, and storage requirements of the structure and material were evaluated, and any previous real-world experience with the technology was documented.

During previous research, a standard sandbag flood barrier was tested in the research basin using a modified standard test protocol to develop baseline data to which data from other types of structures can be compared. The modification to the standard test protocol includes changes to the structure alignment to allow testing of oblique angles with the wave generator.

After the baseline sandbag data were collected in the research basin, the current project tested the RDFW and two other products in the same facility using the modified standard test protocol. Results of all laboratory testing have been posted on a publicly accessible Web site along with information on man-hours and special equipment required to construct and disassemble the flood-fighting structure, and reusability of the materials. That Web site address is <http://chl.erdcl.usace.army.mil/ffs>. The selection criteria and process for the two additional flood-fighting products is described later in this chapter in the “Product Selection Criteria and Process” section.

Concurrent with the research basin experiments, barriers using the same four technologies were constructed on a field site at Vicksburg, MS, where conditions representative of real-world flood-fighting were expected. The four technologies were tested at the field site concurrently. Results of the field testing have also been posted on the Web site. The field tests allowed a complete assessment of operational concerns such as construction of the structure on uneven or sloping ground, end effects or tiebacks, and undercutting.

Non-ERDC members of the PDT observed the tests, advised ERDC members on the appropriateness of elements of the test, and provided input to the reporting. They also were asked to provide summary documentation on any real-world experience they may have with the technologies being tested, and will review the final report.

Laboratory testing

In the research-basin tests, the products were tested in a controlled laboratory setting. Product vendors were required to arrive at the test facility with all specialized equipment and supplies. The Government furnished all typical construction equipment. The vendors were required to have a representative on site to direct the construction and removal of their structures. The structures were constructed and removed by a labor force furnished by the Government. ERDC and other members of the PDT observed and documented the selected protocol-defined metrics associated with the construction and removal. Selected ERDC and PDT members observed the time required to install the test wall and any special equipment requirements. After construction, the vendor was not allowed to adjust the structure during any of the tests specified in the protocol. The protocol does allow the vendor access to the structure a maximum of three times between tests for a limited length of time if such access is required. Any such access to the structure was recorded. A delivery service contract was signed between each vendor and ERDC prior to the study and guidelines for vendor involvement and responsibilities were specified in that document. As all testing costs will be borne by the Government, this contract assured government ownership and responsibility for distribution of the testing results.

The PDT recognized that supplementary tests might be required for a specific structure to supply information deemed crucial to evaluation of the structure. The test

plan allowed that these supplementary tests would be conducted in a manner that would not interfere with the standardized testing protocol. An example of a test that could be conducted in addition to the standardized testing protocol is evaluation of seepage rates on a structure with a punctured or torn seepage membrane.

The products were tested at a field site that experiences backwater impacts from the Mississippi River. The Mississippi River stage was monitored and the time window for product installation was selected based on the predicted date of a river level high enough to inundate the flood barriers being tested.

Vendors were allowed to preposition material at a government-furnished site in the Vicksburg, MS, area. Each selected vendor was contacted and given a notice to proceed to install his barrier. Each vendor was required to install the barrier at the field site within 5 calendar days from the time the notice to proceed was received. The following requirements and information were provided to each vendor:

Each vendor will be provided with a marked 25-ft right of way for construction. Each barrier must be constructed within a 15-ft-wide footprint for the structure within the 25-ft right of way. Actual right-of-way used by each vendor within the provided 25-ft right of way will be measured and reported. The Government will install a large buried concrete tank on the protected side of each vendor's barrier to collect seepage water. Each vendor is required to adapt their construction to overcome any problems that might arise from the tank. The Government will prepare four separate work areas at the field test site for installation of four different temporary barrier-type structures. A random drawing will be conducted to determine which product is constructed on each area.

Construction

For the laboratory testing, each structure was constructed by laborers from the ERDC-WES (Waterways Experiment Station) Department of Public Works (DPW). While skilled at numerous construction tasks, the laborers were not familiar with the vendor products being tested. Each manufacturer provided one person to train and oversee the construction crew. There were no restrictions on number of laborers or equipment operators that could be used, but only one representative of the vendor could work with the crew. Restrictions on heavy equipment (front end loaders, fork lifts, etc.) were based only on what could safely be used at the test facility. However, total man-hours and types of equipment used were recorded and included in this report. The vendor was responsible for construction and removal, transportation, and delivery of its product.

For field-testing, the vendors were required to furnish the appropriate quantity of their flood-barrier material. Unskilled laborers from the U. S. Army Engineer District, Vicksburg, were provided by the Government to construct and remove the structures. This labor force worked under the direction of a vendor representative. Subsequent to completion of all testing, the structures were removed. If the vendors anticipated that their product and materials were reusable, then they were requested to direct removal so as to maintain the reusability of the product. The Government monitored both the installation and removal. The planned field test sections were u-shaped or half-box-shaped structures with the riverward face of the structure a minimum 100 ft long. Test sections were placed along the channel bank line and tied back into high ground. The

length of the tieback sections varied but did not exceed 50 ft in length. The tiebacks had to be long enough that the riverward face of the structures overtopped before the tiebacks flanked.

Additional construction information provided to each vendor included the following:

The Government will grade to bare ground a portion of the field-test-site footprint for the barrier structures prior to installation of the selected vendors' products. The Government reserves the right to artificially wet the field-test site prior to the vendors' installation of their products to best simulate possible real-world flood-fight conditions. Each vendor's product must be sufficiently high to protect against 3 ft of water against the structure. The vendors also will be required to raise his structure during the testing to a height required to protect against 4 ft of water. Each vendor can use the method of his choice to achieve this raise.

Engineering

ERDC activities included engineering support of the testing procedures, instrumentation, observation, and analysis of the structural response to the flood forces, and reporting of the results. ERDC personnel did not assist with construction or removal of the structure.

ERDC engineers and technicians conducted the field and laboratory tests including operation and maintenance of pumps and valves, operation of the wave generator, and operation of the automated data control and processing computers and equipment.

Instrumentation for the laboratory tests included a laser measurement system for determining seepage rates through the structure, laser measurements of deflection of the structure at various key locations, and capacitance wave rods to measure incident wave conditions during hydrodynamic testing. In addition, continuous video recordings were made from two angles during the entire test period, plus additional video and still shots to document all phases of construction, disassembly, and testing.

Instrumentation for the field tests included capacitance rods for measuring water elevation within the structures and external to the structures and for incident wave conditions. Also, continuous high resolution digital camera captures were recorded from two cameras positioned on each structure. Additional video and still shots also documented the construction and disassembly of each structure as well as the actual testing of the structures. The instrumentation also included the development of a method for determining seepage rates that was based on wetter surface area of the structures.

Environmental

The PDT included an environmental engineer who was tasked to issue an environmental opinion concerning use and disposal of products used in the tests. The plan was to include consideration that the product may have become coated or the fill material may have absorbed contaminants due to exposure to floodwaters.

Product Selection Criteria and Process

The Corps was directed by Congress to develop real-world testing procedures for Rapid Deployment Flood Wall (RDFW) and other promising flood-fight technologies.

Due to the need for timely laboratory and field testing of these technologies, the decision was made to test two other products. To select these two products, the PDT issued a solicitation for technical proposals for temporary, barrier-type flood-fight products during March 2004 on the FedBizOpps Web page. Nine vendors provided proposals in response to this solicitation. The vendors' products can be classified as one of three general types. The first type is an impermeable membrane liner either with or without a supporting frame. The second type is a granular-filled container. The third type is water-filled bladders. Of the nine submitted proposals, four were impermeable membrane liners, two were sand-filled containers, and three were water-filled bladders. Table 1 provides a summary of the vendor proposals.

| Table 1-1 Vendor Proposals | | |
|---------------------------------------|----------------------------|--|
| Vendor | Product Name | Type Product |
| Portadam | Portadam | Impermeable-membrane liner with supporting frame |
| Water Guard Pallet Barrier | Water Guard Pallet Barrier | Impermeable-membrane liner with supporting frame |
| Hendee | Rapidam | Impermeable-membrane liner |
| Megasecur | Water Gate | Impermeable-membrane liner |
| Hesco Bastion | Concertainer | Granular-filled, fabric-lined wire baskets |
| West Wind Levee | The Wall | Granular-filled membrane bag |
| Aqua Levee | Aqua Levee | Water-filled bladder |
| Hydrosolutions | Protecdam | Water-filled bladder |
| Flood Master | Flood Buster | Water-filled bladder |

The vendors' proposals were evaluated by a multidisciplinary team on technical criteria. The criteria were developed by the PDT prior to the issuance of the solicitation. The evaluation team consisted of three ERDC researchers and two Corps District employees. The ERDC researchers were Fred Pinkard (ERDC-CHL, research hydraulic engineer), Thad Pratt (ERDC-CHL, research physicist), and Jim Warriner (ERDC-GSL, research geotechnical engineer). The two District team members were Larry Buss (Omaha District, hydraulic engineer) and Matt Hunn (St. Louis District, emergency management civil engineer).

The evaluation criteria required the proposals to be technically sound, operationally functional, and economically feasible. The evaluation criteria, as provided to potential vendors, are furnished as follows.

- a. Documentation shall be furnished that the barrier structure can be installed and removed in the footprint defined in the scope of work for both the field and laboratory deployment. The installation and removal of the structure must be performed using whatever equipment would normally be necessary to install and remove the structure as designed. The vendor must provide enough detail in their installation/removal plan to adequately define all logistical aspects including all labor and equipment requirements for the installation and removal processes. In responding to this item the vendors must cover at a minimum:

- (1) Product's physical footprint requirements (length/width/minimum turns or radius considerations) and construction right of way requirements for field test installation and removal.
 - (2) Durability.
 - (3) Ease of construction.
 - (4) Constructed of environmentally acceptable materials (include materials safety data sheets if applicable).
 - (5) Time required to install at field site.
 - (6) Manpower required to install at field site.
 - (7) All equipment required to install at field site.
 - (8) Time required for removal at field site.
 - (9) Manpower required for removal at field site.
 - (10) Additional equipment required for removal at field site.
 - (11) Adaptability to varying terrain.
 - (12) Environmental considerations at removal to include contamination from floodwaters.
 - (13) Physical storage requirements including space and other considerations such as exposure to elements (sunlight, temperature, acid rain, etc.). Storage space requirements should be provided for a volume of the vendor's product that is required to protect a 1,000-ft-long section with 3 ft of water against it.
 - (14) Seepage through section joints for a 1,000-ft-long section with 3 ft of water against it.
 - (15) Seepage through product barrier for a 1,000-ft-long section with 3 ft of water against it.
 - (16) Fill requirements.
 - (17) Detailed cost and time estimate to construct a 1,000-ft-long section that would hold back 3 ft of water against it based on federally published labor costs for the Vicksburg, MS, area.
- b.* The vendor's proposal must provide engineering details about the barrier structure to show that the structure has the ability to withstand hydrostatic and uplift forces, has adequate anchoring, and provides a factor of safety against sliding and overturning with 3 ft of water against it (to include if anchoring is provided). The vendor should provide an engineering opinion as to the

performance of its product against debris and wave impact and resistance to tearing or breaking during installation and removal.

- c.* Documentation shall be furnished as to how the barrier structure will perform on a freshly graded surface, a grass surface, and a finished concrete surface. Both the freshly graded surface and the grass surface will be present at the field test site. For the laboratory testing, the structure will be constructed on finished concrete.
- d.* The vendor must provide sufficient details for plans of how to repair and maintain their barrier structure during the field test process.
- e.* The vendor must provide documentation as to how their barrier structure will perform against 3 ft of water against it. They will also have to show in sufficient detail how they will raise the level of their structure by whatever means possible to protect against an additional foot of floodwater during the field-testing process.

As a result of the evaluations, the Portadam and Hesco Bastion products were selected as the promising flood-fight technologies to be tested along with the RDFW and sandbags. The Portadam proposal had the best overall combination of technical soundness, operational functionality, and economic feasibility. Hesco Bastion's proposal while technically sound and operationally functional was especially strong in economic feasibility. Contracts with both Portadam and Hesco Bastion were signed on 21 April 2004.

2 Laboratory Testing and Evaluation of Expedient Flood-Fighting Barriers

Introduction

This section of the report documents the laboratory testing and performance of selected commercial vendor-furnished flood-fighting barrier products. Three selected commercial products and a USACE sandbag barrier were tested and evaluated by identical protocol in a controlled laboratory setting. Each of the four barriers (USACE sandbag levee, Hesco Bastion levee, RDFW levee, and Portadam levee) were constructed, tested, and evaluated by ERDC personnel in an ERDC laboratory. Each given barrier was constructed, tested using controlled hydrostatic wave-induced (hydrodynamic) and impact loadings, and removed from the laboratory prior to beginning the same sequence for the next barrier. All tests were conducted and evaluated using one common protocol (Appendix C) in the most objective manner possible, under full oversight and agreement of the respective vendor's representative(s).

Experiment Overview

The four full-scale flood-fighting barriers (levees) were constructed, tested, and evaluated in a controlled laboratory setting by personnel from ERDC's Geotechnical and Structures Laboratory (GSL), Coastal and Hydraulics Laboratory (CHL), Information Technology Laboratory (ITL), and Directorate of Public Works (DPW). Each levee was constructed in a testing zone within a 30-ft length opening inside the wave basin enclosed by the CHL Jay V. Hall steel hangar (Bldg. 6006). Each levee was constructed within a common geometric testing zone laid out on a smooth concrete floor. Fresh clean water was impounded against each levee for specified common test configurations simulating floodwater conditions. At test conclusion, the water was drained and each levee was disassembled for removal from the testing zone.

The levees were built to a height of 3 ft on a finished concrete floor to eliminate foundation settlement, seepage, and scour variables present at actual field sites. The levees were constructed with a 20-ft length wing wall on one side to test the 90-deg corner connection and a 22-ft wing wall on the other side to test the 63-deg corner connection. The levee face parallel to the wave machine was 30 ft long. Hydrostatic testing was performed at various water levels and hydrodynamic testing was performed with wave action of increasing magnitude. In addition, impact testing during hydrostatic loading was conducted to simulate effects of floating debris during flood conditions. No

capability existed in the test basin to generate large steady-state currents along the face of the levees, thus the effects of floodwater currents were not evaluated. When waves pass by the side with a 63-deg corner, the water has an apparent current. During each test, the respective barriers were instrumented and monitored for seepage rate and lateral deflection. Visual observations of material loss, structure response, and failure patterns also were made for each levee.

Visual observations were noted for several criteria in addition to test performance. These observations included constructability concerns (geometric footprint constraints, ease of construction, manpower and equipment requirements, time and cost requirements); sustainability concerns (maintenance and repair during testing); disassembly and storage concerns (manpower, equipment, time, and cost); and environmental concerns (material safety and decontamination aspects).

Testing Equipment and Procedure

Test facility layout and construction

The test facility was laid out along the perimeter wall of a reservoir with dimensions of 115 ft by 185 ft by 4 ft deep. The test facility was reconfigured specifically for innovative flood-fighting experiments by allowing levees to be constructed against two wall abutments with a 30-ft opening between the walls (Figure 2-1). A geometric testing zone footprint was laid out on the concrete floor and all levees were required to be constructed within this given footprint. One side of the footprint abuts the concrete wall at a 90-deg angle, and the other side abuts the concrete wall at a 63-deg angle. The purpose for having two different angles is to simulate real-world geometric variability and demonstrate constructability and geometric flexibility of each vendor's product. Additionally, the unsymmetrical geometry allows wave-loading variability during hydrodynamic testing, and it causes an apparent current along the 63-deg wall.

On the protected side of the levee, a circular pit with an 8-ft diam by 8-ft-deep circular pit was designed and constructed to catch any seepage or overflow water from the structure. Two 4-in.-diam pumps are installed in the pit to pump the accumulated water back into the wave basin. Two 12-in.-diam pumps (12-in. intake and 10-in. output) were also installed to pump excess water out of the pit when the capacity of the 4-in. pumps was exceeded.

The walls were constructed of concrete masonry blocks as shown in Figure 2-1 with concrete knee braces added on the pool side. The walls and knee bracing were locked in place with rebar grouted into the floor of the wave basin and into the knee braces to prevent the walls from moving. The knees were placed on the outside of the wall due to physical constraints of the equipment storage and instrumentation requirements. Aluminum walkways were placed on the block walls.

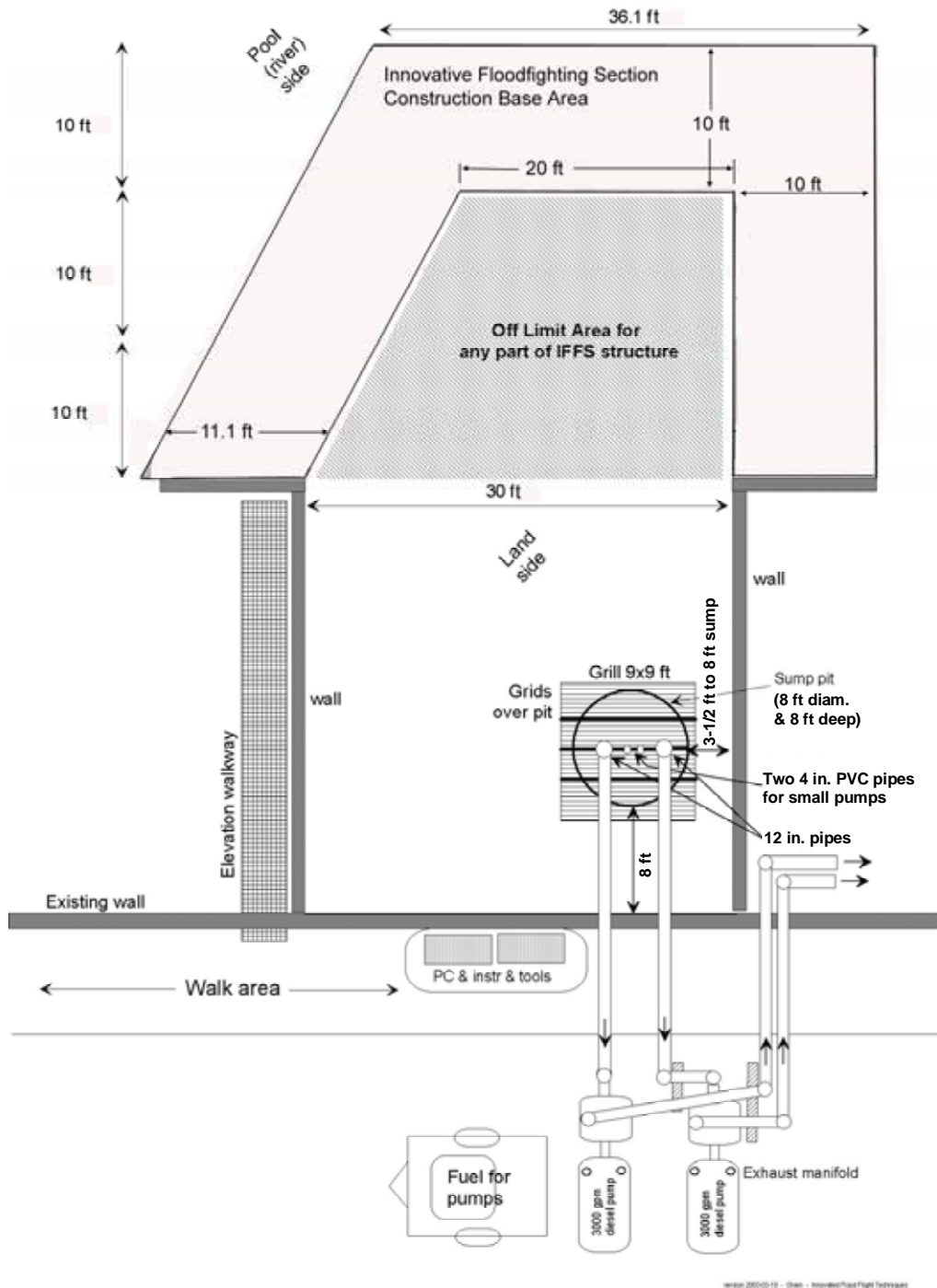

Figure 2-1. Layout of laboratory test facility

The 8-ft-diam circular sump was manufactured from an 8-ft-long corrugated steel culvert with a welded steel bottom and was placed in an excavated hole 9 ft below floor grade. A 1-ft-thick reinforced concrete slab was poured in the bottom of the hole, the vertical cylinder was installed, and a 1-ft-thick concrete mass was placed on the bottom of the cylinder. Concrete was placed around the cylinder's periphery and formed to fit the lattice steel walkway at the top of the culvert.

Two 4-in.-diam pumps were installed in the sump pit bottom. The two pumps are switched on as the water level reaches its upper float elevation (limit) and off as it reaches a lower float elevation (limit). The float with switching equipment work to control the pumps. The system with pumps, switch controls, manifolds, valves, and flow meters is shown in Figure 2-2. Each pump has a maximum flow capacity of 326 gpm against a 12-ft head, which is sufficient for all projected seepage rates (except levee overtopping).



Figure 2-2. Sump pit containing two 4-in. pumps. Top left: top of sump pit. Top right: power control panel. Bottom left: 4-in. pumps in pit. Bottom right: 4-in. valves and flow meters

Two diesel-powered 12-in.-diam pumps were installed to meet the highest pump capacity requirements during levee overtopping (~3000 gpm each). Associated plumbing for the pump system was also installed in the facility. The system with pumps, manifolds, and flow meters is shown in Figure 2-3.



Figure 2-3. Pumping system used for overtopping, 12 in. diam. Top left: diesel pumps. Top right: flow meter. Bottom left: pipes leaving basin to pumps. Bottom right: pipes from basin to pumps and back to basin

Test facility instrumentation

The instrumentation station is mounted just behind the pool wall directly facing and parallel to the wave machine. For uniformity and ease of understanding, looking at the inside of the levees from the instrumentation station will be called the center of the levee. Right and left of the instrumentation station will be the right and left side of the levee as shown in Figure 2-4. The letters from “a” to “i” are used to show relative location on the structure. All letters are assumed to be on the center of the levee. The letter “a” is at the right wing wall, “b” is at the center of the first levee wall, “c” is at the corner of the two adjoining levee walls, “d” is 5 ft in from the right corner, “e” is 10 ft in from the right corner, “f” is 15 ft in from the right corner or 5 ft from the left corner, “g” is the left corner, “h” is at the center of the diagonal levee wall, and “i” is at the left wing wall.

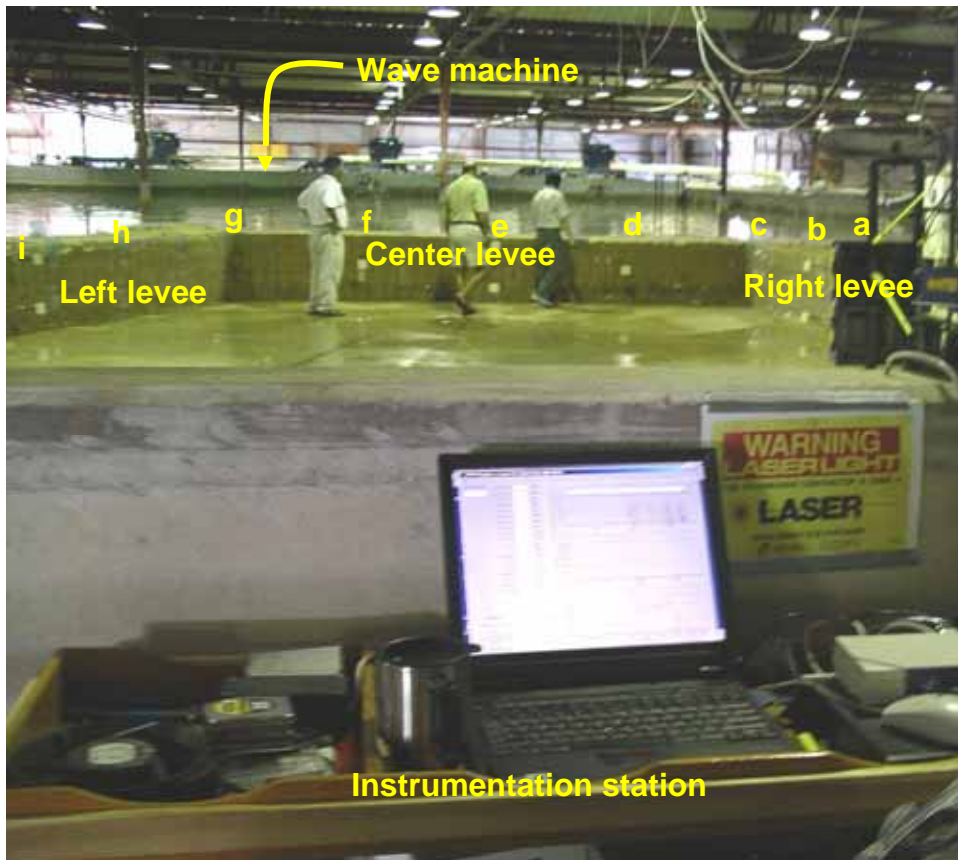

Figure 2-4. Laboratory setup

Instruments are used to measure flow rate from the 4-in. pumps (water volume/time) and water level inside the pit. Distances from the outer reservoir to two points on each longitudinal dry side levee wall (top and bottom) are monitored via eight laser-beam transducers to determine horizontal levee wall displacement during testing. Horizontal displacement of the center section is measured at a point near the center. The onsite computer recorded all input data (seepage flow rate, water level, and displacement). Wave basin data (reservoir height, wave generation, and hydraulic parameters) were monitored separately. The data acquisition system was placed on the outside of the pool wall behind the test section as shown in Figure 2-5.

The water level inside the pit from bottom of the sump pit (elevation zero) to a maximum elevation of about 48 in. above the top of the pit is measured with a laser float system (Figure 2-5). A 12-ft-long stilling pipe (12-in.-diam PVC) with holes around the bottom is placed in the pit to calm the water running into the pit. The depth of the float placed in the 12-in. pipe is measured by a laser pointed at the center of the float. The water depth or elevation relative to the bottom of the pit is recorded every second during any given test.

The outflow from the sump pit (through the two 4-in. pumps) is measured with Omega flow meters (Figure 2-6). The data acquisition computer (programmed in Visual Basic®) records the flow meter data. The pit water level and pump flow rate as functions of time calculate the water inflow rate (seepage rate) into the pit.



Figure 2-5. Seepage and displacement data retrieved by data acquisition system

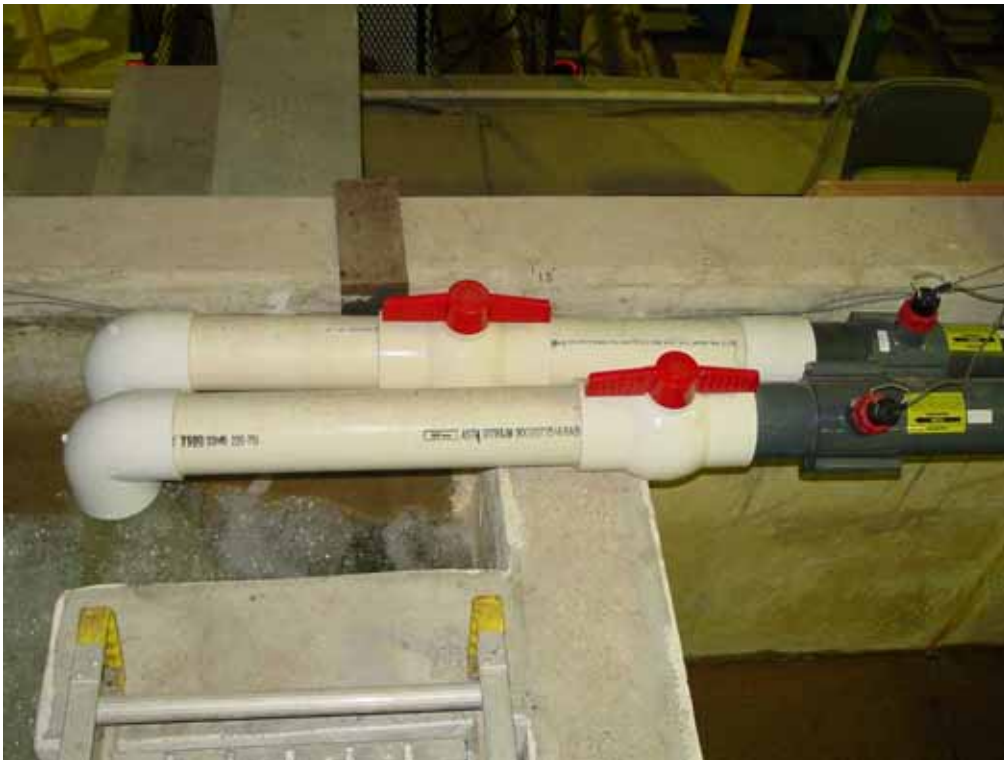

Figure 2-6. Sump pit outflow pipes and flow meters

The displacement (horizontal and overturning) of the protective side of the levee was measured with optical lasers having a maximum range of 50 m and an accuracy of ± 3 mm. Movement was measured with the lasers at the top and bottom of each levee wall section at its longitudinal center, and movement is monitored at either end of the center section. The lasers reflected off white standoff targets attached to the levee. These standoff targets were placed approximately 12 in. in front of the levee to allow uninterrupted laser measurements during water overtopping (Figure 2-7).

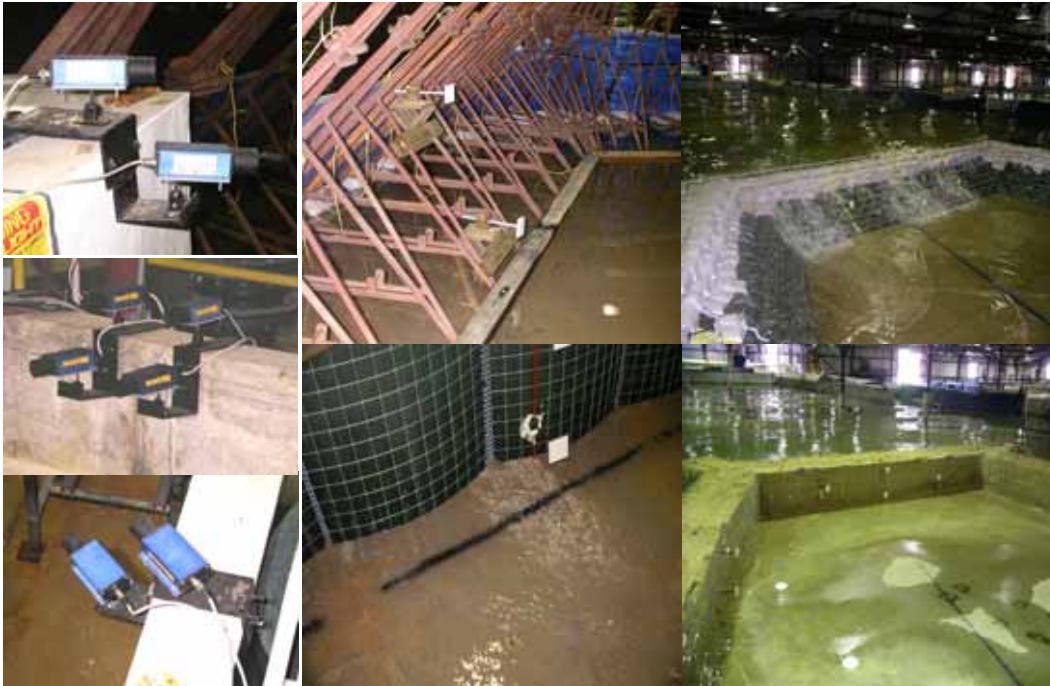

Figure 2-7. Lasers and laser targets. Left side, top to bottom: three pictures of lasers. Top middle: laser targets on Portadam. Top right: laser targets on sand bags. Bottom middle: laser targets on Hesco Bastion. Bottom right: laser targets on RDFW

The sketch in Figure 2-7a contains the position of each of the eight lasers used and location on the levee at which it records any movement. These lasers record movements with an accuracy of ± 3 mm. The laser targets were placed on the levees at points B, D, E, F, and H as seen on the Figure 2-7a. At points B, E, and H the one laser is aimed at a target placed within 3 to 8 in. from the top of the levee, and a second is placed the same distance from the bottom of the levee. Laser lines D and F are aimed at a single target placed at the center of the elevation of the levee at each of these two locations.

The use of lasers resulted from prior testing of a product that moved forward and rotated during testing (static and dynamic testing). During the 2004 tests, any movement during testing was less than the minimum measurable value with this system (± 3 mm). Example test results (one plot for each laser, Figures 2-7b through 2-7i) follow. The results from a dynamic high wave test with pool elevation equal to 80 percent of the pool height (80%h) displaced no more than ± 3 mm.

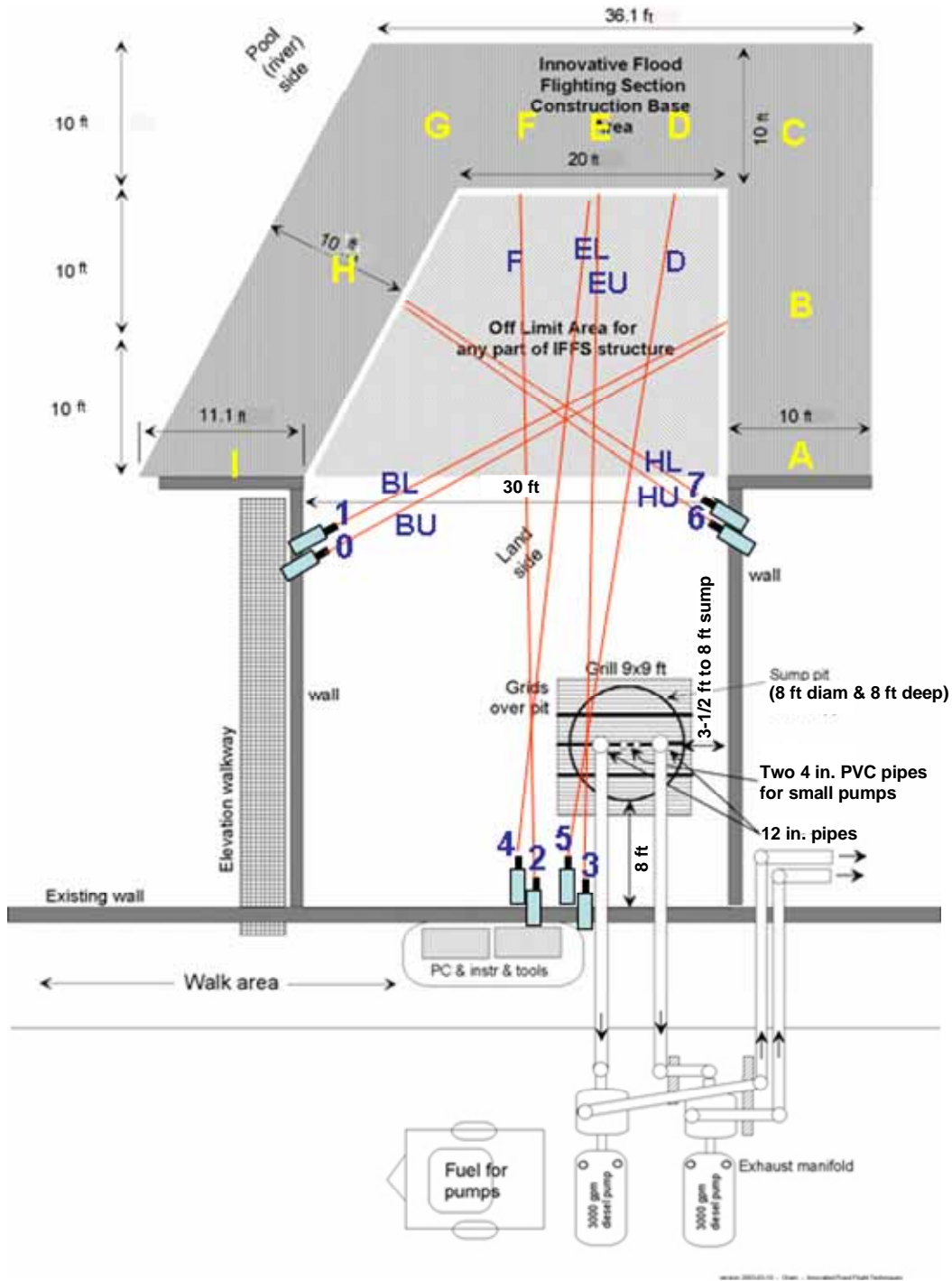

Figure 2-7a. Lasers and their targets on levee

Visual monitoring of the levee along the top and along the longitudinal center of the levee was accomplished where possible using a yellow stationary cable suspended about 1 to 2 in. above the levee and a blue strip painted directly on top of the levee. This stationary cable provides qualitative monitor of movement if large movements occur during testing. Video cameras recorded movement along the levee's parallel and

perpendicular axes during the tests. The relative movement system is shown in Figure 2-8.

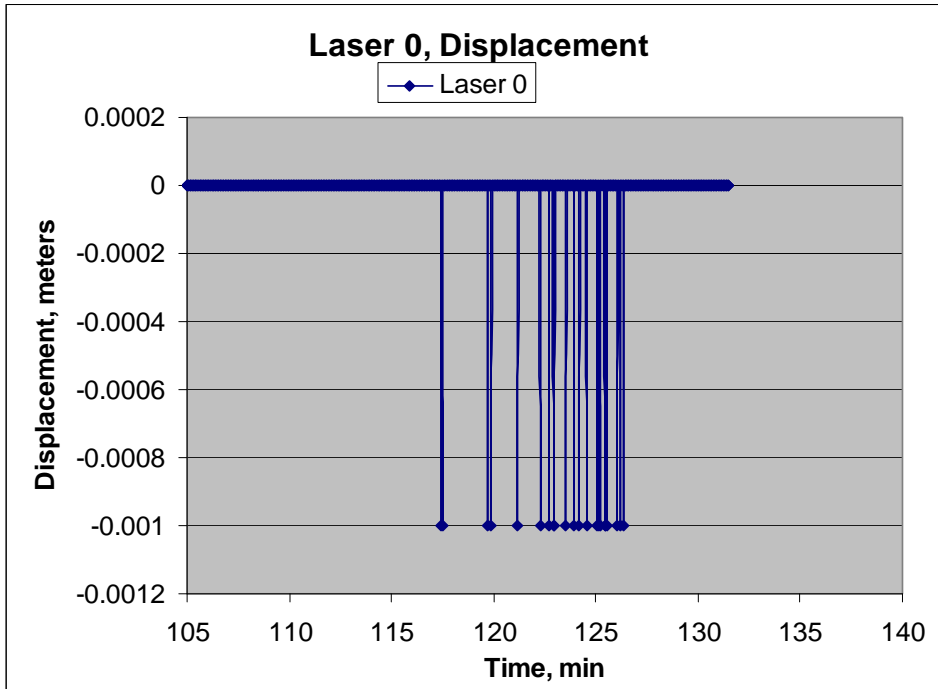

Figure 2-7b. Displacement data from laser 0

A floating-debris (log) impact-test apparatus was designed, constructed, and installed specifically to retract a wire cable attached to the log. The apparatus consists of an electric motor geared to a cable spool with remote control and safety trip wire capabilities. The apparatus is mounted on a steel frame attached to the test basin floor. The apparatus is installed and remotely controlled to provide a log impact speed of 5 mph at an approximate angle of 70 deg with the horizontal.¹ As the log is pulled into the levee, a trip wire switches off the winch just inches from the levee. This keeps the log from being pulled by the cable after impact. The complete system is shown in Figure 2-9.

¹ Horizontal equal to a line parallel to the wall where the computer acquisition system is stationed.

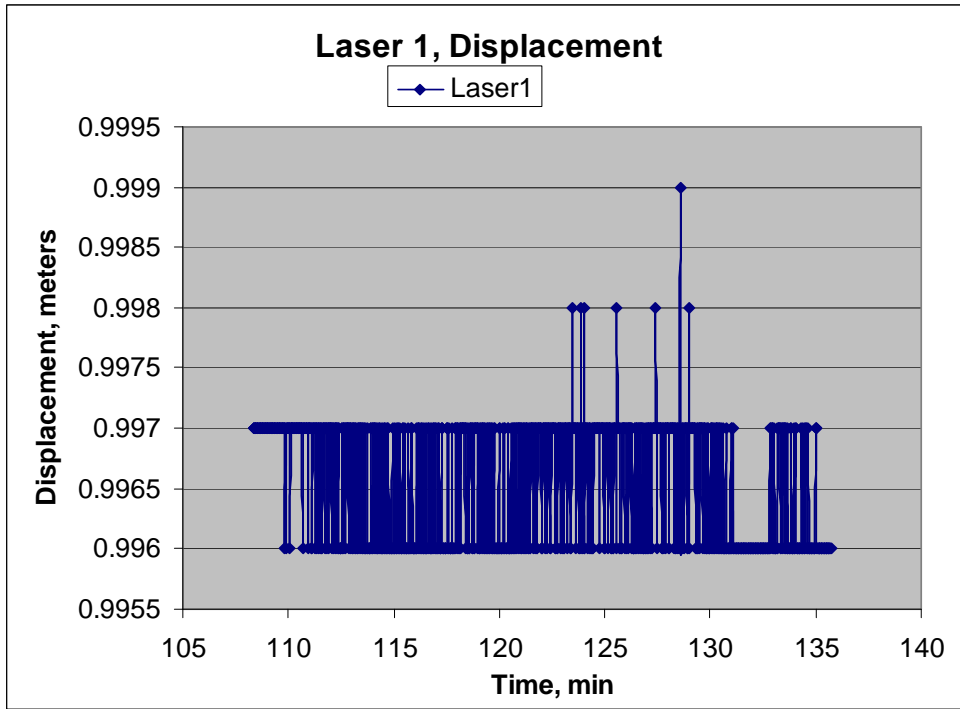

Figure 2-7c. Displacement data from laser 1

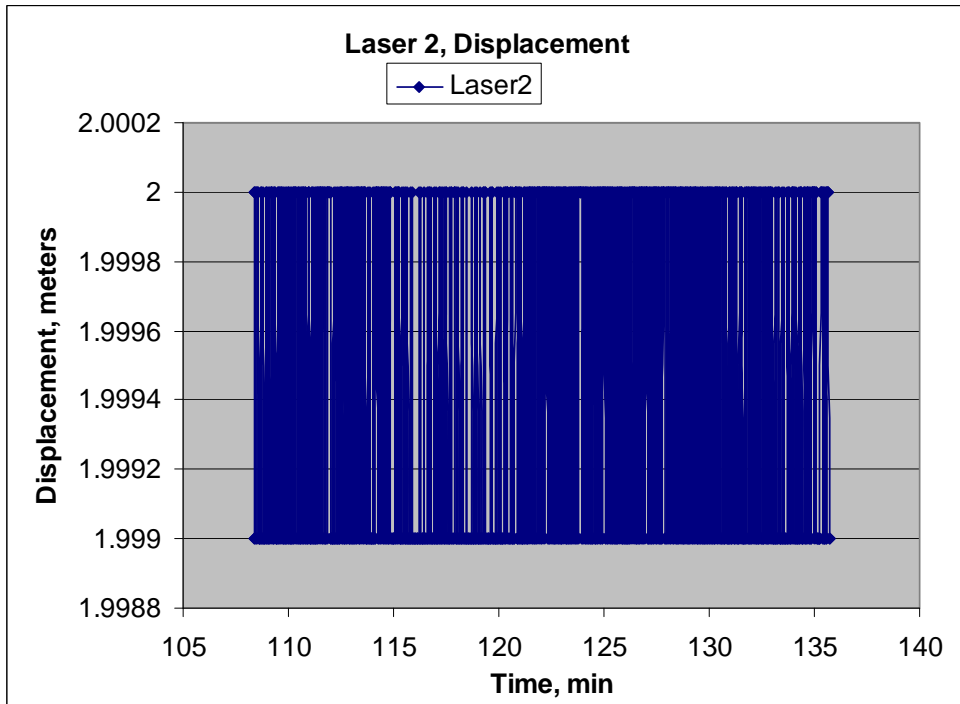

Figure 2-7d. Displacement data from laser 2

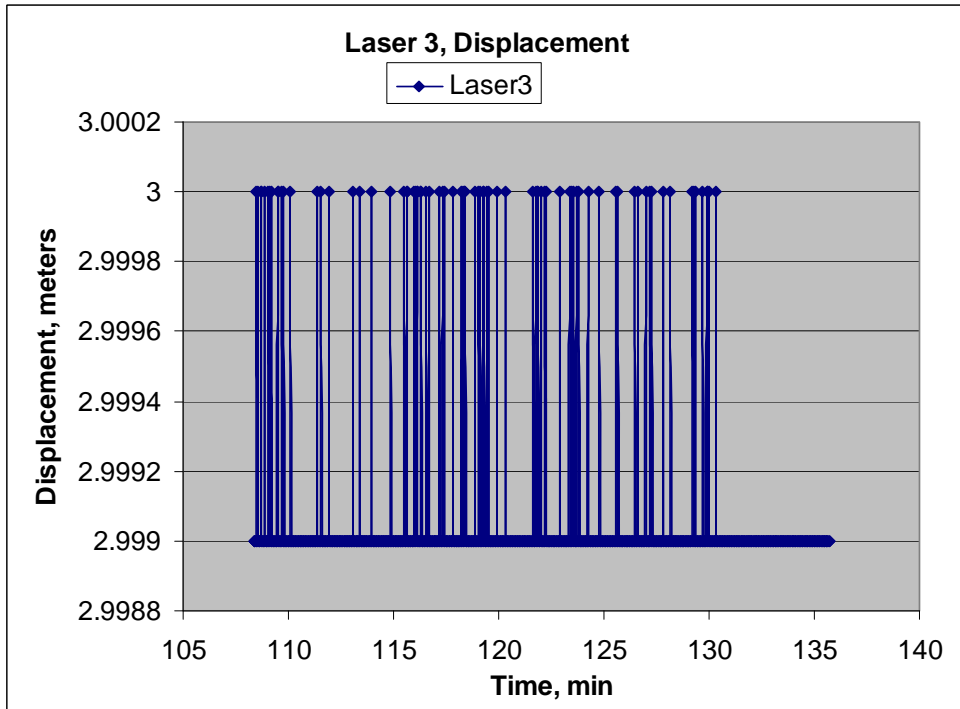

Figure 2-7e. Displacement data from laser 3

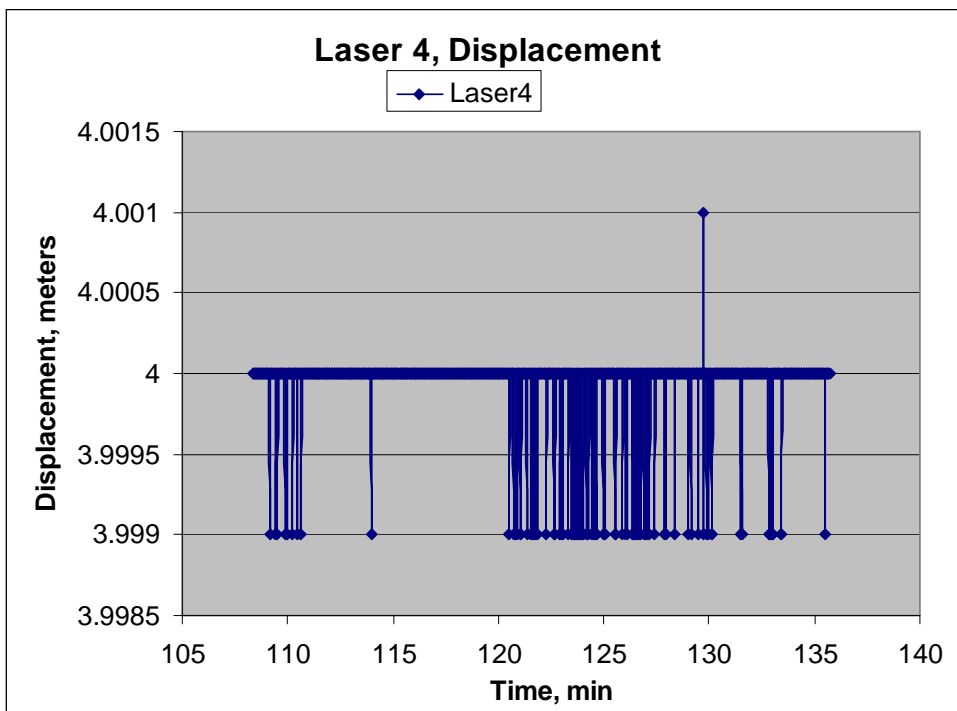

Figure 2-7f. Displacement data from laser 4

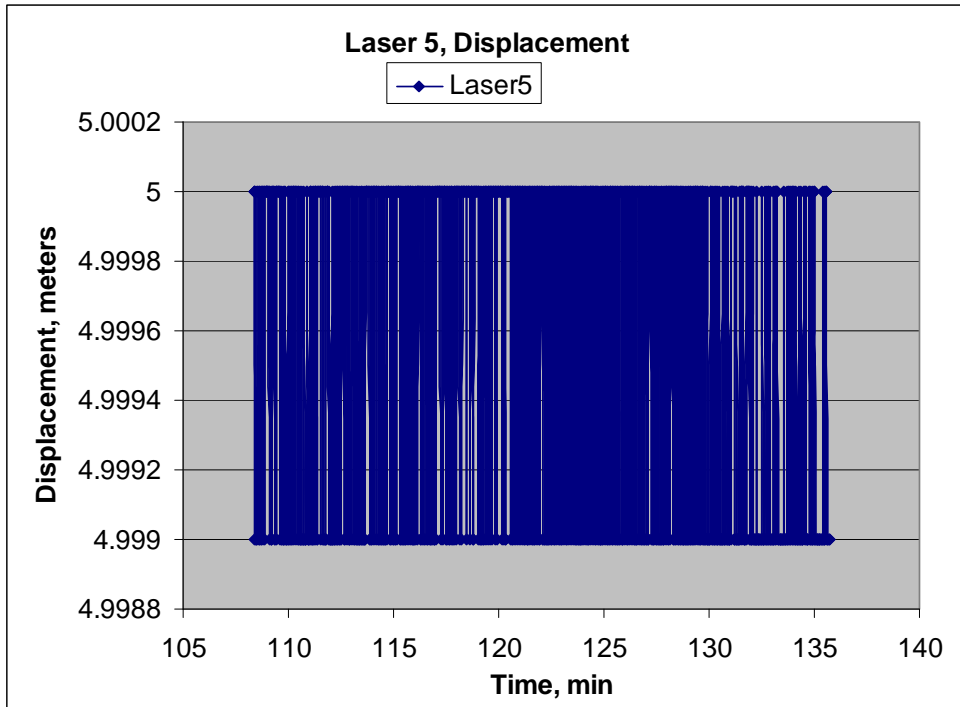

Figure 2-7g. Displacement data from laser 5

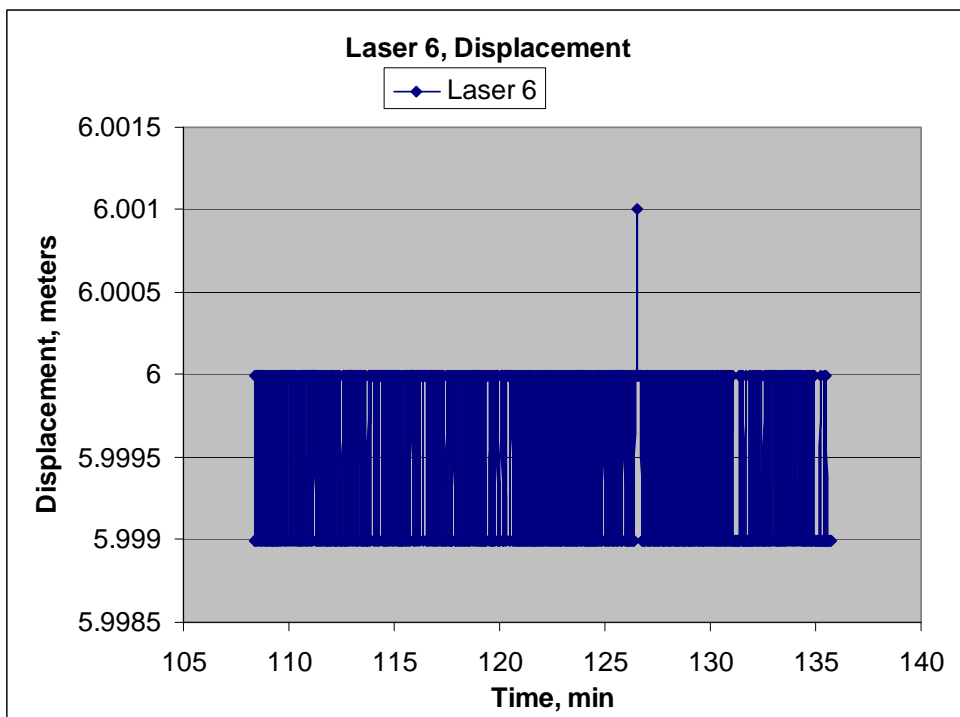

Figure 2-7h. Displacement data from laser 6

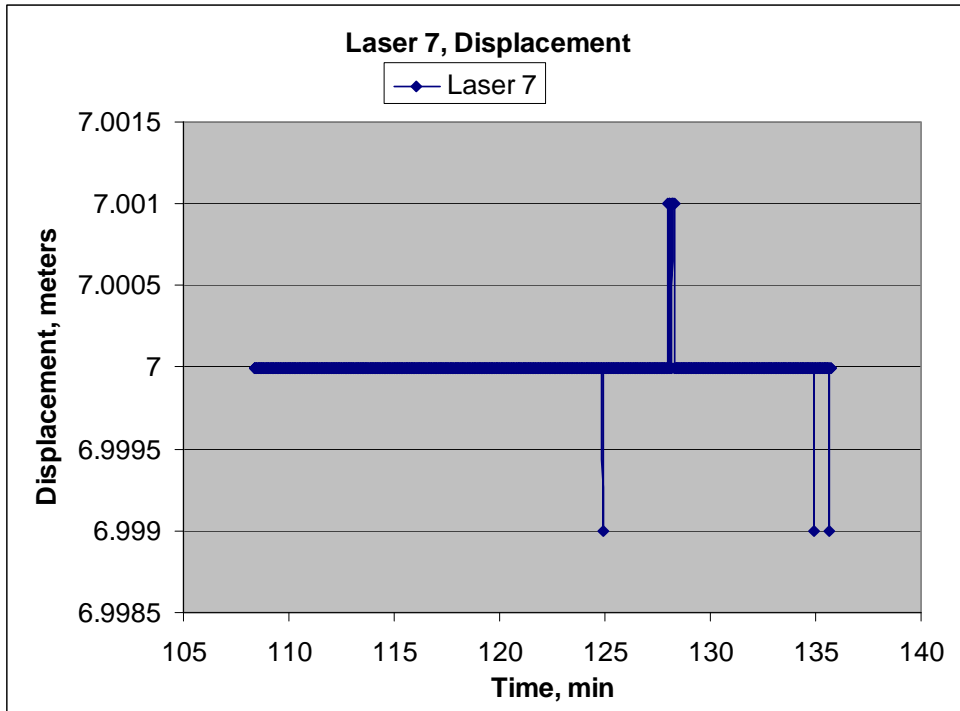

Figure 2-7i. Displacement data from laser 7



Figure 2-8. Relative movement and video monitoring system



Figure 2-9. Debris impact test setup (a) Winch (b) Controller (c) Trip wire, (d) Desired path for log being towed

The pool is filled from a large sump, which when completely full contains enough water to fill the reservoir to an elevation of 3 ft. The two pumps are switched on and off at a point near the sump. The water can be pumped into and out of the pool area with the valves and pumping manifold. The two pumps are capable of filling the reservoir to an elevation of 1 ft in 1.5 hr. The system is shown in Figure 2-10.

A constant reservoir pool height is maintained with an electronically controlled elevation system as shown in Figure 2-11a. Reservoir water-level measurement is monitored with a laser float system similar to that used for pit elevation monitoring. The major difference is that a 4-in. pipe is used as the stilling basin and the float is much smaller. The data acquisition system records these data once every second as is done with all data recorded. The laser and stilling basin for the pit elevation is shown in Figure 2-11b.

CHL personnel operated and maintained the wave generation system and measured the wave heights and periods during the hydrodynamic tests. The wave machine may be seen in Figure 2-12a and 2-12b. The wave gages were placed at desirable distances from the levee and the wave generator, shown in Figure 2-12c and 2-12d.

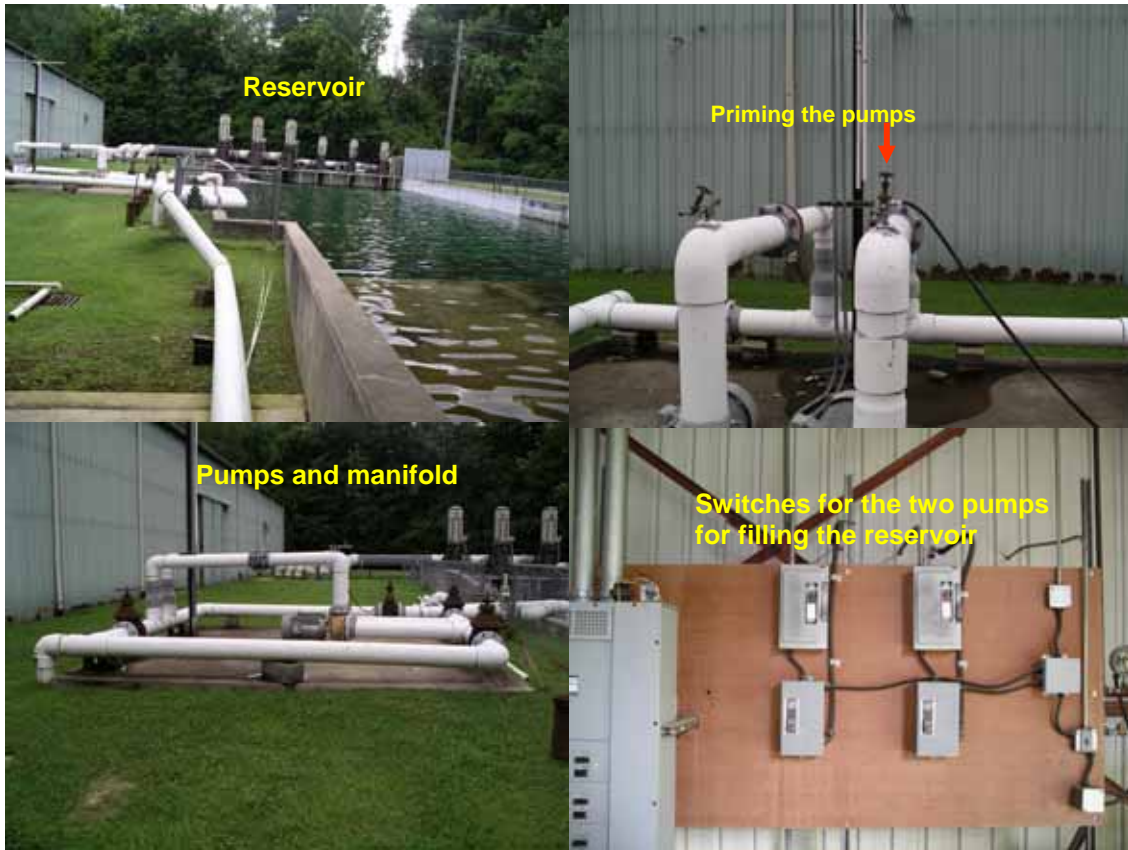

Figure 2-10. Reservoir-filling system

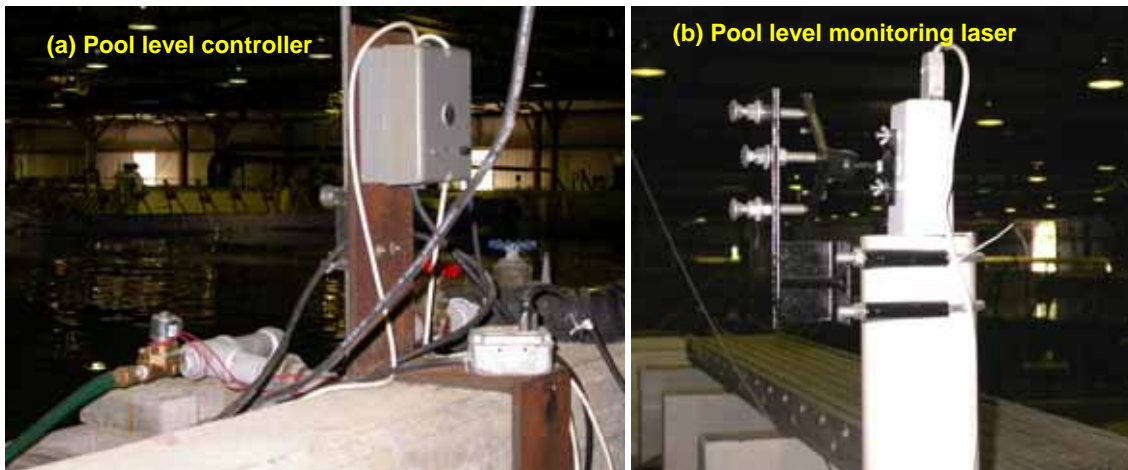

Figure 2-11. Pool level equipment (a) Controller (b) Monitoring laser

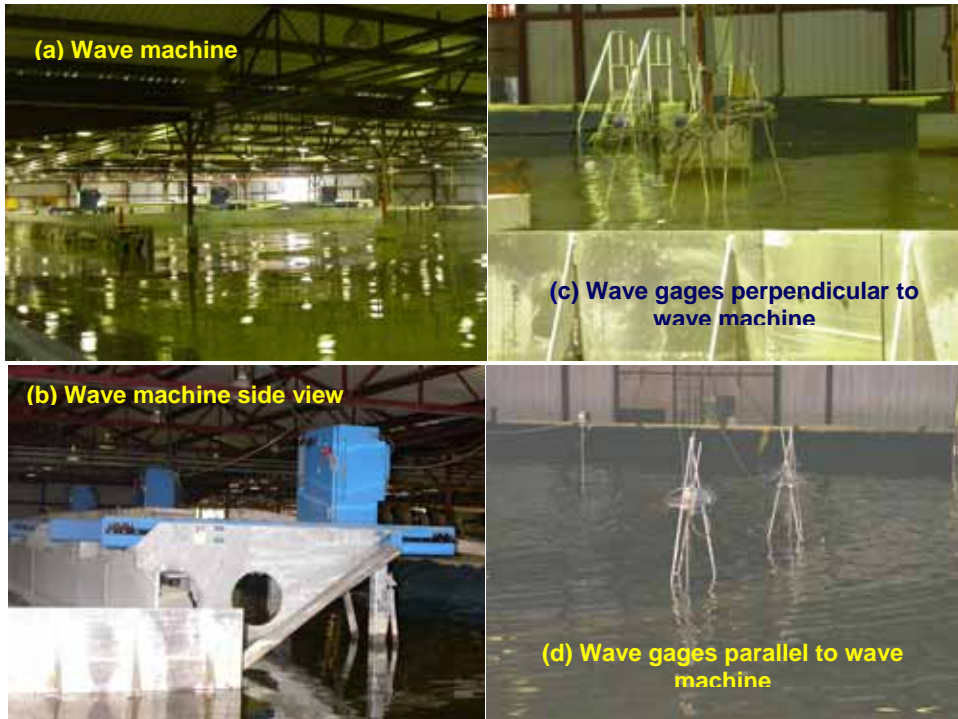

Figure 2-12. Wave generator and equipment (a) Wave machine, (b) Wave machine side view, (c) Wave gages perpendicular to wave machine, (d) Wave gages parallel to wave machine

An attempt was made to capture the wave height and period data and correlate it to the seepage and displacement data recorded by the separate data acquisition systems. A separate wave gage was used to capture these data as the waves were hitting the levees as shown in Figure 2-13.

Testing protocol

The Standard Testing Protocol (STP), referenced in Appendix C of this report, is briefly described as follows. The STP is applicable to all levee structures tested in the laboratory and documented in this report.

For a commercial product to be tested it must meet all of the criteria listed in the STP. The product is to have an engineering-based study performed to establish structural stability, with calculations presented for water pressure at all elevation up to 100 percent of the product height, and must have previously completed manufacturers' testing.

The testing protocol requires hydrostatic and hydrodynamic conditions, levee overtopping, and impact tests to be performed. For the hydrostatic tests, the pool elevation in front of the dam is raised to three different elevations (33 percent, 66 percent, and 95 percent of levee height) for a minimum of 22 hr at each elevation. It was later decided that the first two elevations should be 1 ft and 2 ft to ensure hydrostatic comparability regardless of levee height. During the testing period, levee movement and seepage values are recorded. During and after each test the levee is inspected for weakness and/or failure before the pool elevation is raised to the next level.



Figure 2-13. Separate wave conductivity rod, correlating waves with seepage

Hydrodynamic tests are performed at two different pool elevations (66 percent and 80 percent of levee height). At 66 percent height, 3-in. waves (measured from trough to crest) are generated continuously for a period of 7 hr. Waves ranging from 7 to 9 in. are then allowed to impact the structure a total of 30 min (three 10-min intervals). Next, wave heights ranging from 10 to 13 in. are allowed to impact the structure for 10 min. The water is then to be raised to a level of 80 percent levee height and the tests repeated. At the end of each 10-min increment of wave testing (excluding the 7 hr of 3-in. waves), the testing basin is to be stilled for 15 min between each test interval to allow the waves to dissipate.

Seepage and displacement measurements are to be taken and digital tapes record test data. During and after testing at each pool elevation, the levee is visually inspected for weakness and/or failure before the pool elevation is to be raised to the next level.

Overtopping is accomplished by raising the water level while allowing it to spill over the top of the levee into the test area. At first, the 4-in. pumps are used to pump the water out of the sump back into the pool. When the 4-in. pumps can no longer keep up, the 12-in. pumps are engaged one at a time with the engines running at a low rpm. The test

begins when either the pool water level reaches 1.5 in. above the average levee height or the pumps are pumping at their maximum rpm and the water level in the pit is at a constant elevation, whichever comes first. Once the test begins, the pumps circulate the water at that constant pool water elevation for a period of 1 hr or until levee failure.

A total of three minor repairs are to be allowed during the testing operation. These repairs are limited not only in time but in man-hours and materials (see Appendix C for detailed information).

The final tests performed are the two separate impact tests. Two different-sized logs impact the structure at 5 mph. The logs are nominally 12-in. and 16-in. in diameter and 12 ft in length. The logs are cut perpendicularly to their length with a chain saw and left rough with sharp edges. After testing, the levee is inspected (where possible) for weakness and/or failure before the second impact test is performed. Displacement measurements are digitally recorded and the tests videotaped.

USACE Sandbag Levee Tests

Design

The first sandbag levee built on the innovative flood-fight project was in 2002 and was based on the U. S. Army Engineer District, Seattle sandbag-levee-construction protocol shown in Figure 2-14. In this protocol, the sandbag levee is constructed using off-the-shelf materials and readily available equipment. Materials include the sandbags and sand. Hand filling requires manual laborers with shovels. Alternatively, sandbags may be filled on or offsite with sandbag filling machines. The sandbag filling machines may have small or large spouts; they may contain motor driven augers; and they often have vibrators to keep the sand moving into the spouts. There are various companies that sell mechanical sandbag fillers and others that sell ready-filled sandbags. A front-end loader is generally used where sandbags are being filled. If the bags are filled offsite, then a truck is needed to convey the bags to the point where they will be deployed.

The Seattle District protocol allows the use of sandbags filled to two-thirds full and the bags occupy a space of 10 in. wide by 12 in. long by 4 in. high. The weight of a bag filled two-thirds full is determined by the density of the fill material. The bags filled in the 2002 test were 45 lb \pm 3 lb. The bags used to construct the sandbag structure were filled with a sandbag filling machine manufactured by Hogan Manufacturing Co. The Hogan machine uses a fixed volume auger and produces sandbags with constant volume (machine shown in Figure 2-15).

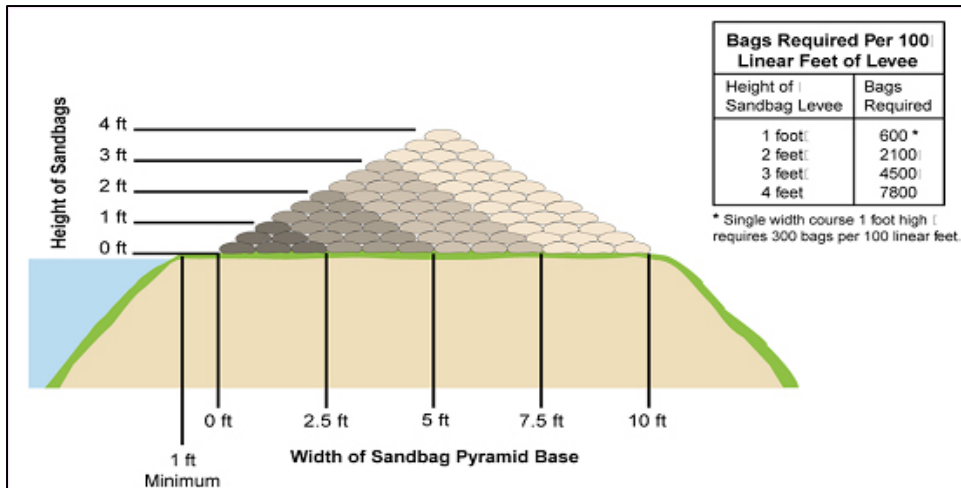

Figure 2-14. Seattle District standard sandbag levee design



Figure 2-15. Hogan Manufacturing Co. sandbag filling machine used to build pretest sandbag levee

According to the Seattle District protocol, a 3-ft-high sandbag levee having one sandbag on top will require a base 9 bags wide (90 in. or 7.5 ft) and uses 4,500 sandbags per 100 ft as can be seen from Figure 2-14. A 3-ft-high sandbag structure with two sandbags on top will be 10 bags wide (100 in. or 8.33 ft) and uses 5,300 sandbags per 100 ft. Note that the U. S. Army Engineer District, Walla Walla uses a base width three times that of the height as its minimum width criteria as shown in Figure 2-16. Seattle District also allows the use of this criterion.

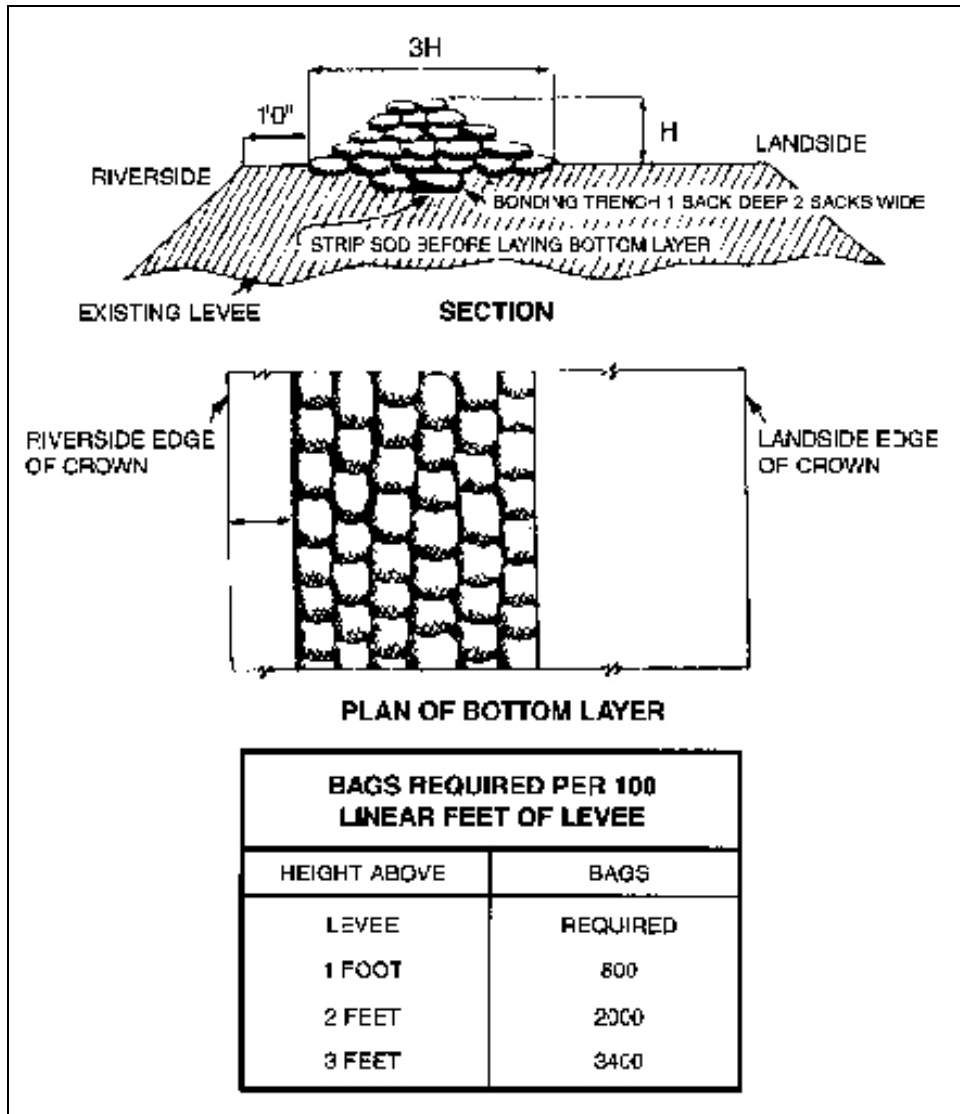

Figure 2-16. Walla Walla District standard sandbag levee design

Both the U. S. Army Engineer Districts, Walla Walla and Seattle show that the sandbags are folded under and the weight of the bag rests on the fold. The open end (not sewed) of the sandbag faces the current. Both districts also indicate that a sandbag in the same line and the same level is placed upon the end of the last sandbag (Figure 2-17).

The 2002 sandbag levee was built without any instruction or supervision from a person with field experience. The as-built structure is shown in Figure 2-18.

The sandbags were placed too high upon the preceding sandbags and did not lie flat on the concrete floor like those in Figure 2-17. This made each layer higher than it was supposed to be.

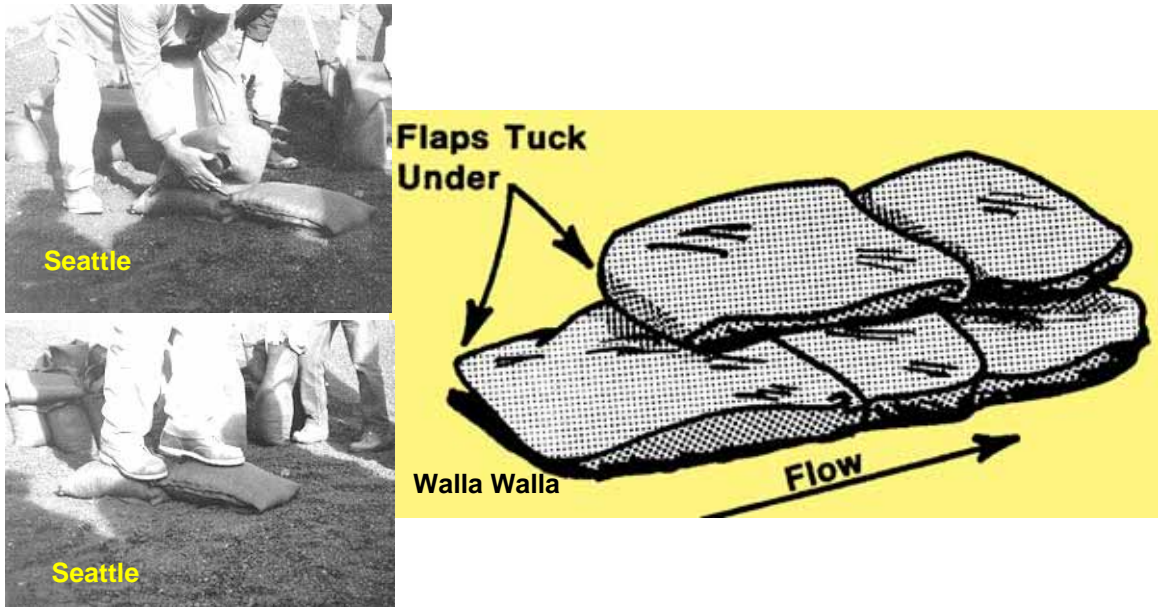

Figure 2-17. Walla Walla and Seattle Districts' design for placing sandbags

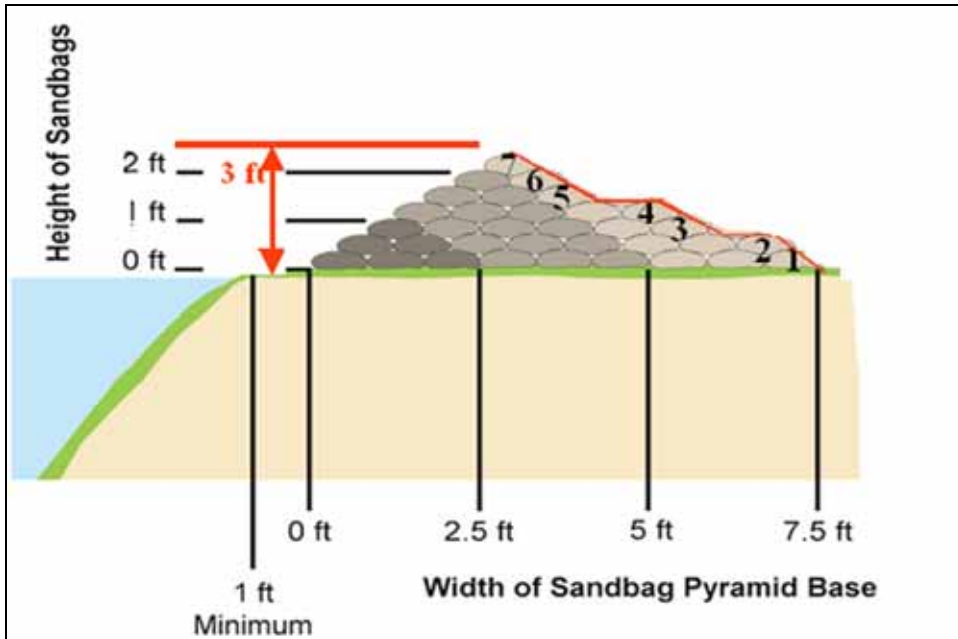

Figure 2-18. 2002 levee, as-built

The structure did not appear as the Seattle District's design because of the stacking problem, and it also had a void between each connecting bag. The resulting voids caused the pretest sandbag levee to seep excessively (7 gal/ft of levee at a water elevation of 95 percent times the height of the structure). A safety analysis of the as-built structure was performed with the following results. For the sandbag levee with water at 3-ft elevation on the poolside, the factor of safety against sliding was calculated to be 1.75 (friction factor of 0.45), and the factor of safety against overturning was calculated to be 2.49.

Another sandbag levee was constructed as part of the 2004 series of tests. Because of the massive seepage through the 2002 sandbag structure, experienced personnel supervised the construction of the sandbag levee in the 2004 tests. The U. S. Army Engineer District, Vicksburg's Emergency Management (EM) supervisors came to the ERDC Laboratory with laborers from the Vicksburg District to build the sandbag levee using the District EM protocol. Major changes from the 2002 levee were that in the 2004 test the bags were filled only one-third to two-thirds full, and the resulting 25-lb bags were not folded.

Construction

The laboratory sandbag levee for the current project was constructed in March of 2004. Although, the temperature inside the enclosed metal hangar ranged from 55 to 70 deg, providing pleasant working conditions, the work was fast-paced and fatiguing due to filling, stooping, lifting, carrying, and placing sandbags. Fans were placed in the work area, and water and electrolytic fluids were made available to all workers. The 17 full-time workers and four part-time workers were closely watched to ensure no one was overstressed or fatigued.

The construction team arrived on 15 March 2004, 0730 hr, and the sandbag levee construction began. Five of the 21 laborers were stationed at the manual sandbag filling machine (Kanzler Sandbagger®) which is shown in Figure 2-19. Two three-man teams manually filled sandbags with shovels. One of the manual teams is shown in Figure 2-19. A front-end loader with operator kept the sandbagger hopper full, supplied sand to the manual sandbaggers, and carried filled bags to the levee for placement (Figure 2-19). The remainder of the laborers carried and stacked sandbags during the construction of the levee (Figure 2-19).

Six thousand sandbags were brought to the site and 5,500 were filled and placed as per the Vicksburg District method. The time required to construct the 62 lft of levee (measured along the protected toe) was 11.5 hr. The construction required 205 man-hours or 3.3 man-hours per linear foot of levee. The level of difficulty is classified as "simple," meaning no special training or skills were required to do any of the jobs with the exception of the front-end loader operator.

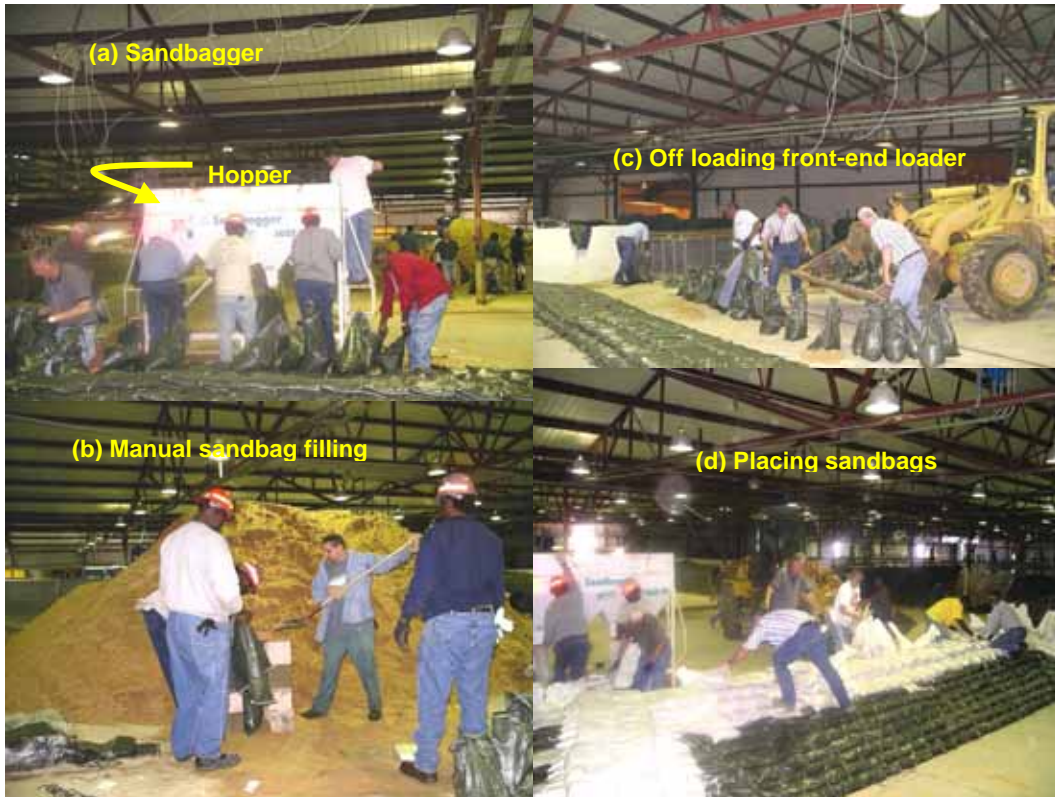

Figure 2-19. Sandbagging operation

The sand was from a commercial source with which District personnel were familiar. It was poorly graded (SP of Unified Soil Classification System) with approximate moisture content 8 percent as shown in Figure 2-20. Each woven plastic sandbag (flat dimensions 14 in. \times 24 in.) was fairly uniform and weighed about 25 lb (\pm 2 lb). Bags were filled using the manually operated sandbag filler provided by the Vicksburg District or manually filled by shovels. Sandbag weight was checked periodically.

The sandbag levee was built to the geometry shown in Figure 2-14. The goal was to have nine layers of sandbags at 4-in. height per each layer or 36 in. high (3 ft) as per the Seattle District design. In theory, a base 10 bags wide (about 100 in.) and nine layers high would make a sandbag levee 36 in. high with two sandbags on top. The Seattle District folds the bags under and each folded end leaned on the end of the preceding sandbag. During sandbag levee construction, the Vicksburg District laps their bags, which means the open end of the bag lies flat and the next bag lays on top of the preceding bag's flap and the sewed end of the bag being placed pushes tightly against the open end at the filled portion of the preceding sandbag as shown in Figure 2-21. The bags are then walked on to compact even tighter and flatter.

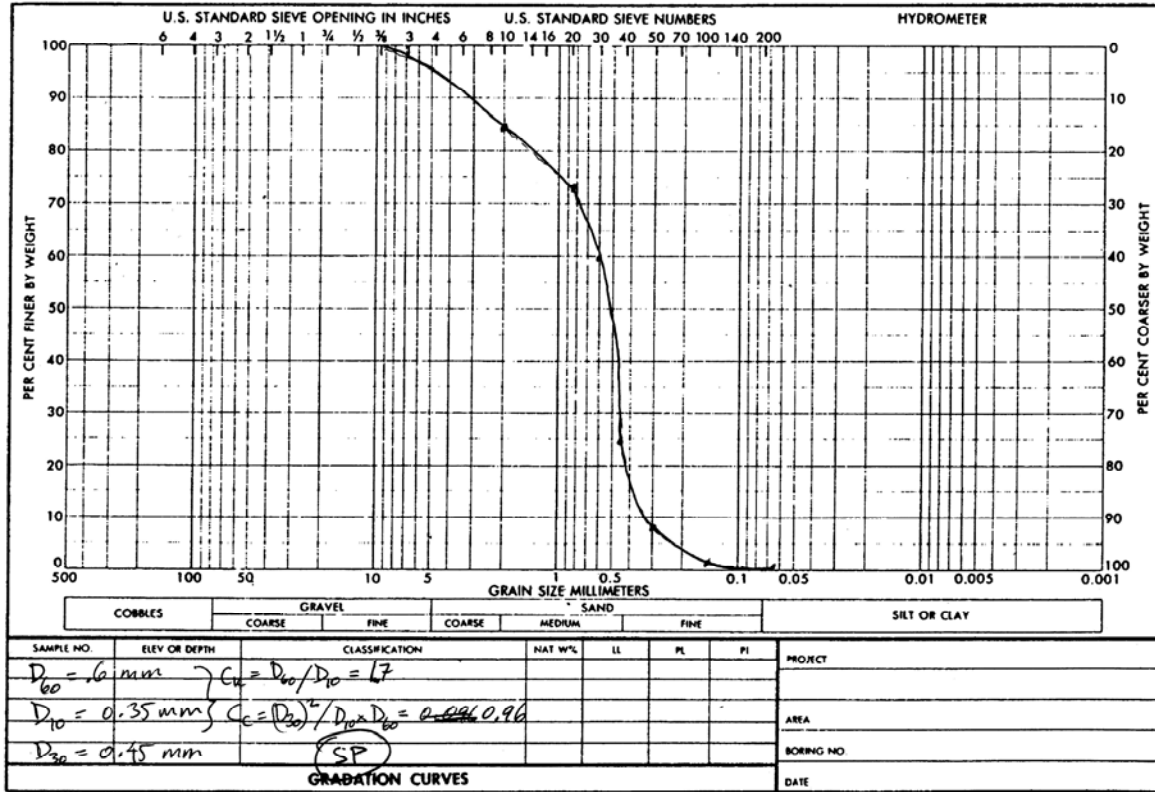

Figure 2-20. Gradation of sand used for filling sandbags

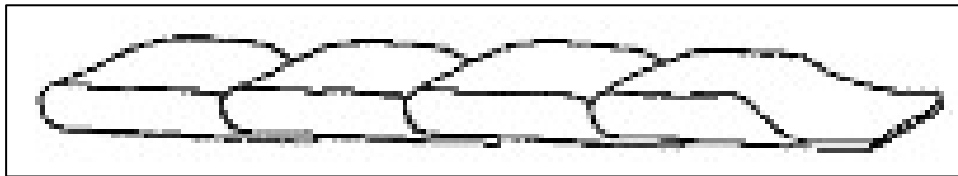

Figure 2-21. Lap stacking sandbags during construction

The 25-lb sandbags filled by the Vicksburg District when laid flat were about 10 in. wide, 12 in. long, and 3 in. high. The maximum base allowed by the testing protocol is 10 ft wide or 12 bags wide (120 in.). To have two sandbags on top would require only 11 layers or 33 in. high. One more 2-wide layer (layer 12) was placed on top of layer 11 to reach the 36-in. height. Since not all of the sandbags were 3 in. thick, there were high and low places on the levee. Various sandbags were laid alongside the top layers on either side of the levee; however, they were not tied into the main sandbag structure. This made a weak zone that was discovered during hydrodynamic testing. The finished levee and partial crew is shown in Figure 2-22.

The average height of the sandbag levee as-built was 2.997 ft (low point 2.805 ft and high point 3.115 ft). Prior to filling the reservoir to begin the hydrostatic tests, laser targets were positioned in the sandbags (Figure 2-23). The representative USACE

personnel reached verbal agreement that the levee had been constructed adequately and was ready for testing.

Performance

Testing began after construction of the barrier was completed. Three minor repairs were allowed within seven windows of opportunity during the tests, as noted in Appendix C. Before the initial overtopping test, the barrier failed when subjected to large waves used to calibrate the structure for the sandbags and subsequent structures. The outer sandbag layer parallel to the wave machine was removed. Tied sandbags weighing 45 to 50 lb were placed from the floor to the top of the sandbag levee to replace those removed. An attempt was made to level the top of the levee.

Disassembly and removal of the barrier was performed after testing was completed and the test basin was drained. An environmental evaluation was also performed for the barrier system, to include environmental hazards aspects of construction and disposal.

Hydrostatic head tests

The pool elevation was sequentially raised to three different levels for a minimum of 22 hr at each predetermined elevation. During the testing period, levee displacement and seepage flow rates collected at the sump pit were recorded. During and after each test, the levee was inspected for weakness and/or failure before the pool elevation was raised to the next level.



Figure 2-22. Complete sandbag levee with partial construction crew



Figure 2-23. Sandbag levee with three of eight targets ready to test

Hydrostatic-head test, 1-ft reservoir (33 percent height). Water was first raised to the 1-ft level on the 3-ft-high sandbag levee, or approximately one-third the height of the levee. About 5 hr were required for filling the reservoir. The water was allowed to stand at that level for approximately 17 hr. The instrumentation recorded levee displacement and inflow from seepage through the levee. The levee was videotaped during all of the static testing. The range of seepage flow rate per linear foot of center-line length was 0.046 to 0.053 gpm/ft. The graph of seepage per linear foot with time can be seen in Figure 2-24. The most seepage (leakage) occurred at the block wall/sandbag interface and at the two sandbag corners.

The data in the graph (Figure 2-24) appears erratic. The large pumps used to fill the basin quit working and the data files were interrupted with some lost time. This was the first test and the data acquisition system stopped taking data 15 times, but the problems were resolved before the next tests. The plot shows the elevation with time and the seepage per linear foot. The seepage per linear foot starts high after filling and drops off with time. The water level increases with time from 12.24 to 12.28 in., but was controlled well by the automatic water-level system.

Hydrostatic-head test, 2-ft reservoir. Water was raised to 2 ft on the 3-ft-high sandbag levee (approximately two-thirds of the total levee height). The water was allowed to stand at that level for approximately 22 hr. The instrumentation recorded levee displacement and inflow from seepage through the levee. The levee was videotaped during all of the static testing. The range of seepage flow rate of center-line length was 0.20 to 0.25 gpm/ft. The graph of seepage per linear foot with time can be seen in Figure 2-25. The majority of seepage (leakage) continued at the block wall/sandbag interface and at the two sandbag corners.

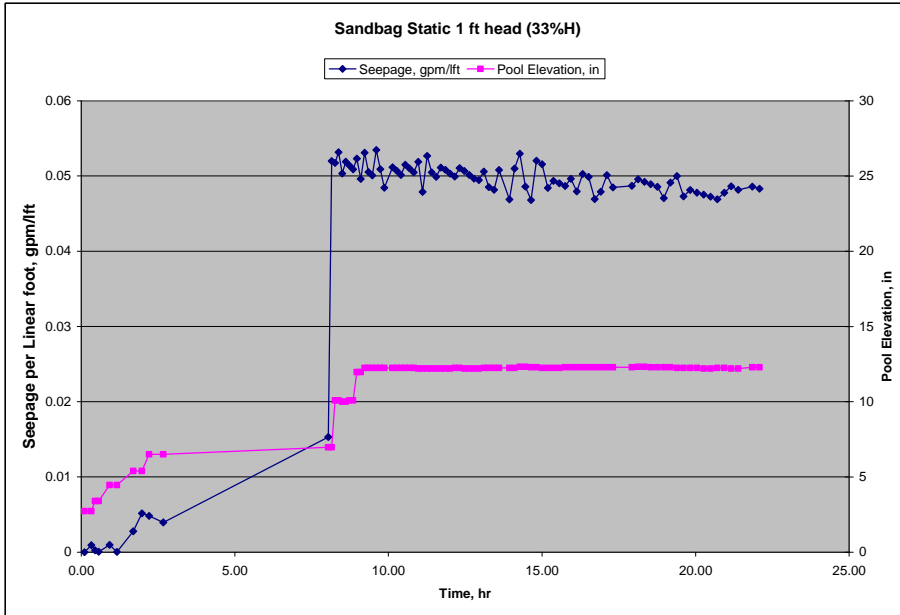

Figure 2-24. Seepage per linear foot at 1-ft head and under static conditions

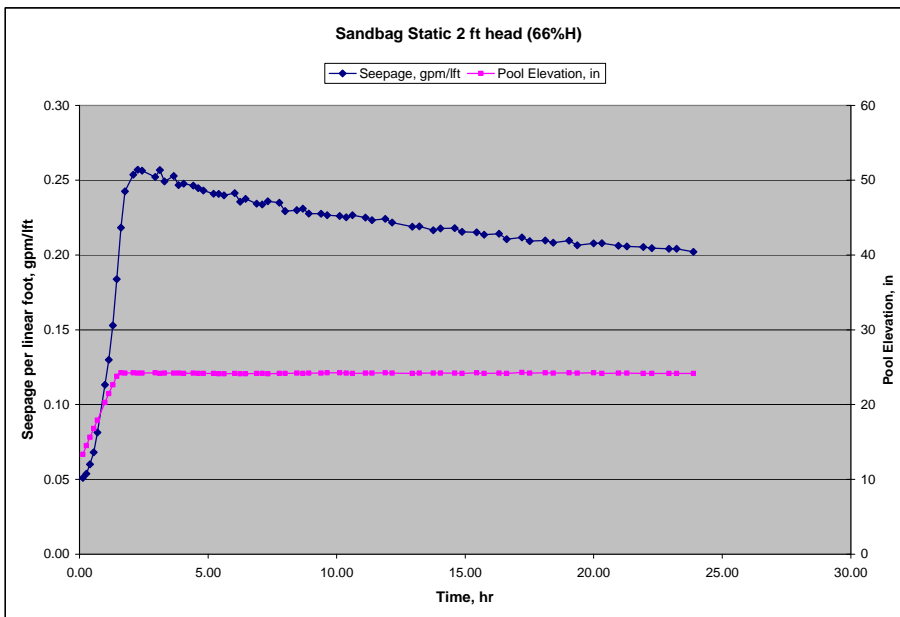

Figure 2-25. Seepage per linear foot at 2-ft head and under static conditions

The plot of seepage per linear foot shows seepage rates during filling and then runs the full 22 hr. The seepage per linear foot and water level both decrease (Figure 2-25).

Hydrostatic-head test, 3-ft reservoir. Water was raised to a height of slightly less than 34.2 in. or approximately 95 percent of the total levee height. The water began to overtop the levee so the water level was lowered to 32.4 in. or 90 percent of the average height of the levee, and allowed to stand at that height for 22 hr. The instrumentation recorded levee displacement and inflow from seepage through the levee. The levee was videotaped during all of the static testing. The range of seepage rate of center-line length

was 0.45 to 0.63 gpm/ft. The graph of seepage per linear foot with time can be seen in Figure 2-26. Again, there was no displacement during this test, and most seepage (leakage) occurred at the block wall/sandbag interface and at the two corners. The large seepage at the beginning is a result of the overtopping resulting from the low points in the levee. The water was lowered and the maximum seepage afterward was 0.55 gpm/ft. When the water level was lowered to 90 percent of the height (32.4 in.) the seepage gradually decreased with time, however the water level also decreased slightly with time.

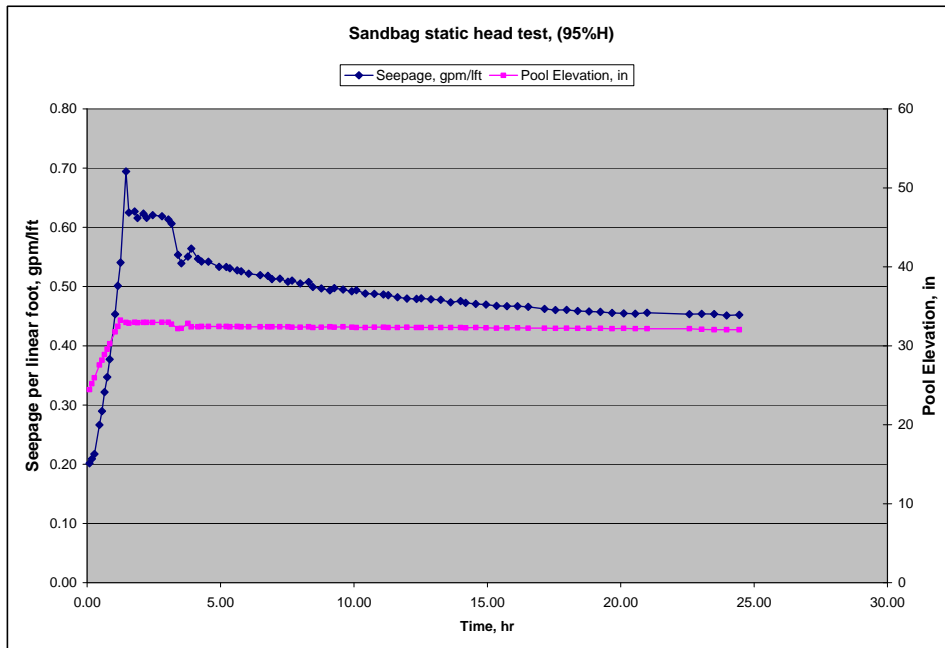

Figure 2-26. Seepage per linear foot at 32.4 in. (95% H) of head and under static conditions

Hydrodynamic tests

The testing protocol specified that packets of monochromatic waves with a wave period $T = 2.0$ sec be generated to impact the sandbag levee hydrodynamically. Hydrodynamic tests were performed at two different pool elevations (66 percent and 80 percent of levee height). At the 66 percent height, 3-in. waves (measured from trough to crest) were generated continuously for a period of 7 hr. Waves ranging from 7 to 9 in. were then allowed to impact the structure a total of 30 min (three 10-min intervals with 15-min calming periods between). Next, wave heights ranging from 10 to 13 in. were allowed to impact the structure for 10 min. The water was then raised to a level of 80 percent levee height and the preceding tests were repeated. At the end of each 10-min increment of wave testing (excluding the 7 hr of 3-in. wave test), the testing basin was stilled for up to 15 min to allow the waves to dissipate.

Following construction of the sandbag levee, the wave machine was calibrated. Damage to the sandbag structure during calibration was not expected based on the results of previous sandbag structure tests. The wave machine was calibrated (2004 sandbags test) for the small 3-in. waves, which were to run for 7 hr. We tried the calibration of the 3-in. waves and noticed that a large amount of material was washing out of the structure

coloring the water red from the fines leaching out of the sand. During the calibration of the 7-in. waves, more discoloration of the water was noticed. Sandbags were washed away from the side and the top of the center of the structure. Figure 2-27 shows that sandbags moved between point c and point g. The structure was rebuilt and the top of the levee was leveled. Because this happened in calibration of the wave machine prior to the actual testing, it is called a rebuild. This calibration was for all products to follow and was not part of normal testing. Total rebuild time was 11 hr with four people or 44 man-hours. The levee after the rebuild is shown in Figure 2-28.

3-in. wave test, reservoir level at 66 percent levee height. The water level in the reservoir on the pool side of the sandbag levee was lowered from 90 percent of levee height to a pool height of 24 in. within an interval of about 2 hr. The wave generator was activated and the waves began to impact the levee. No overtopping was observed, the seepage rate ranged from 0.25 gpm/lft to 0.29 gpm/lft, and no displacement was observed. The 3-in. waves removed no bags. The seepage during this is documented in Figure 2-29.

7- to 9-in. wave test, reservoir level at 66 percent levee height. This test was actually performed after the 10- to 13-in. wave test (due to operator error). The water level in the reservoir on the pool side of the sandbag levee was held at 24 in., and the wave heights were increased from 7 in. to 9 in. for a period of 10 min. The test was then stopped for about 15 min between each of the three test increments to allow stilling of the basin. Seepage flow rates ranged from 0.23 to 0.32 gpm/lft and no displacement was observed during the tests. No major overtopping occurred, however, the seepage did increase slightly during each 10-min test as is shown in Figure 2-30. Two sandbags were displaced into the pool from the middle of the structure.



Figure 2-27. Damage done during calibration of wave machine



Figure 2-28. Sandbag levee after repair

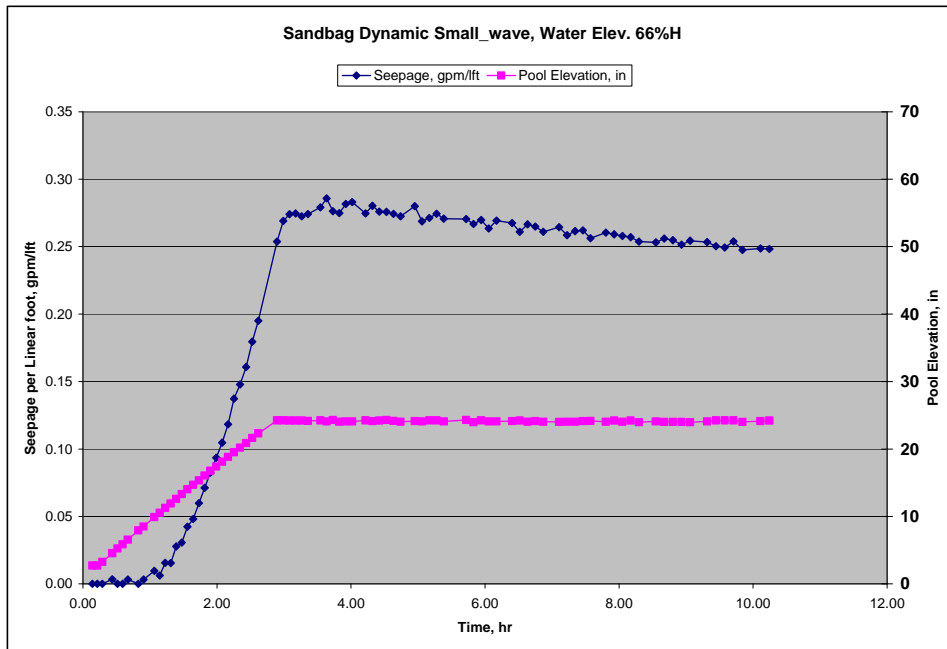

Figure 2-29. Seepage with dynamic testing at 66 percent levee height and 3-in. waves for 7 hr

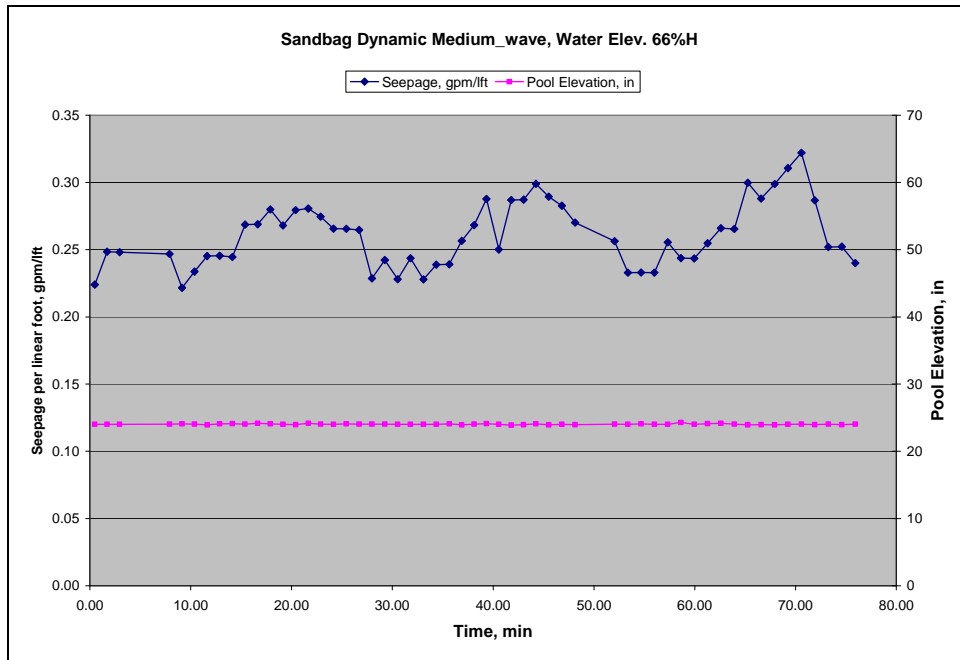

Figure 2-30. Seepage with dynamic testing at 66 percent levee height and 7- to 9-in. waves

10- to 13-in. wave test, reservoir level at 66 percent levee height. The water level in the reservoir on the pool side of the sandbag levee was held at a height of 24 in., and wave heights were generated from 10 to 13 in. for a period of 10 min. Wave overtopping occurred at each wave front, which significantly increased the observed flow rate in the sump pit from 0.23 gpm/ft up to 3.19 gpm/ft. The seepage plot is shown in Figure 2-31. Nearly all of this is overtopping, not seepage through the levee. No displacement was observed. Damage occurred during this test requiring Repair 1. Repair 1 is discussed in the maintenance section of this chapter.

3-in. wave test, reservoir level at 80 percent levee height. The water level in the reservoir on the pool side of the sandbag levee was raised to a height of 28.8 in., and 3-in. waves were generated in packets of 10 min each. The test was then stopped for about 15 min to allow stilling of the basin. This sequence was repeated three times for this test. Seepage flow rates were observed to range from 0.38 to 0.4 gpm/ft and no displacement was noted. No wave overtopping occurred. The seepage data are shown in Figure 2-32. The test was uneventful, looking much like a seepage test except there is no decrease in seepage with time.

7- to 9-in. wave test, reservoir level at 80 percent levee height. The water level in the reservoir on the pool side of the sandbag levee was held at a height of 28.8 in., and wave heights were generated in packets of 7 to 9 in. for a period of 10 min. This sequence was repeated three times.

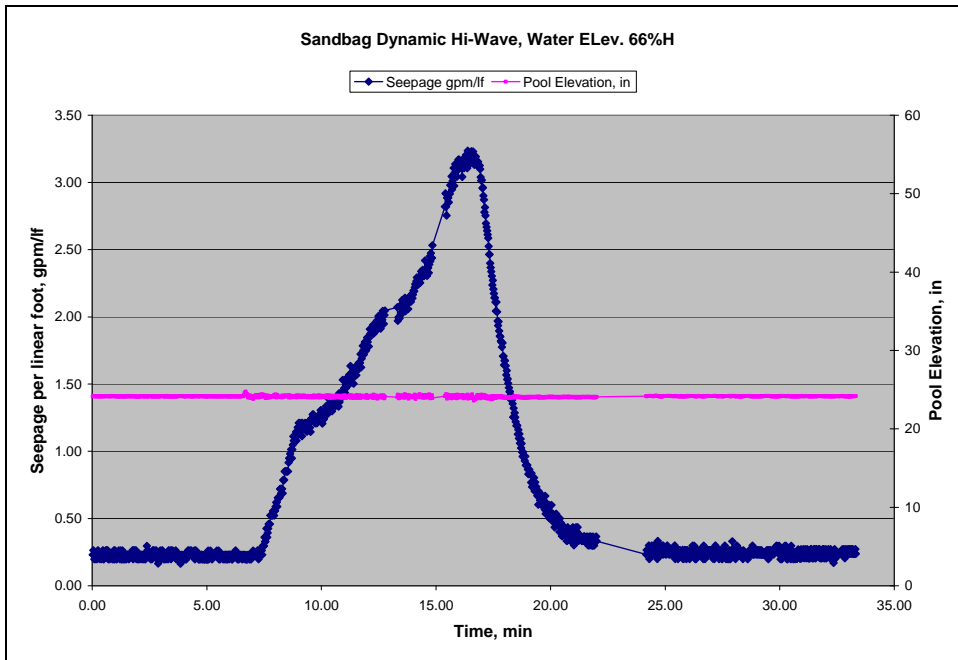

Figure 2-31. Seepage with dynamic testing at 66 percent levee height and 10- to 13-in. waves

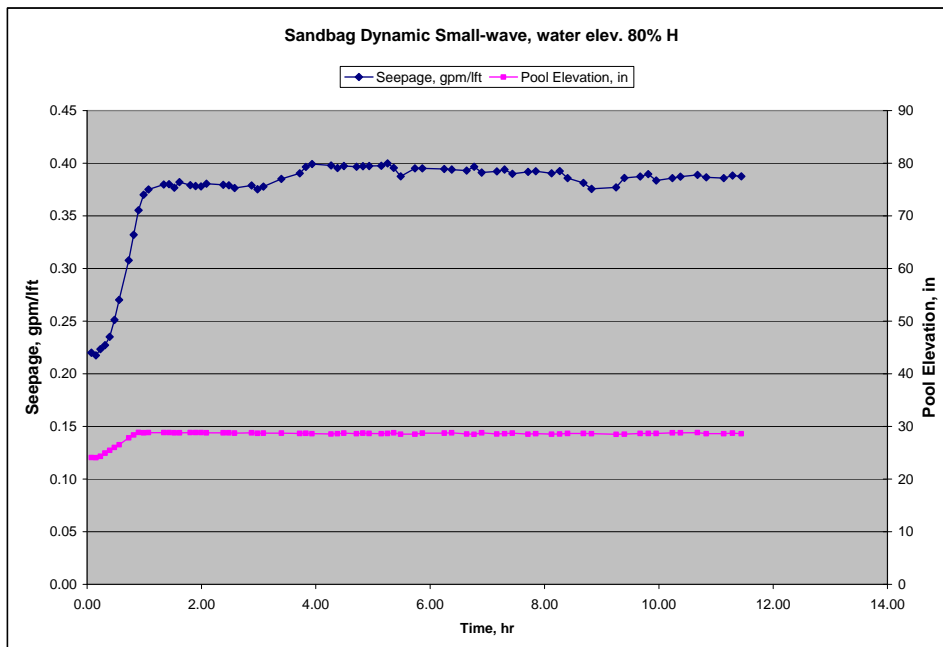

Figure 2-32. Seepage with dynamic testing at 80 percent levee height and 3-in. waves for 7 hr

Flow rate significantly increased from 0.38 to 7.42 gpm/lft due to overtopping of each wavefront. No displacement was observed. The amount of water going through and over the barrier is shown in Figure 2-33.

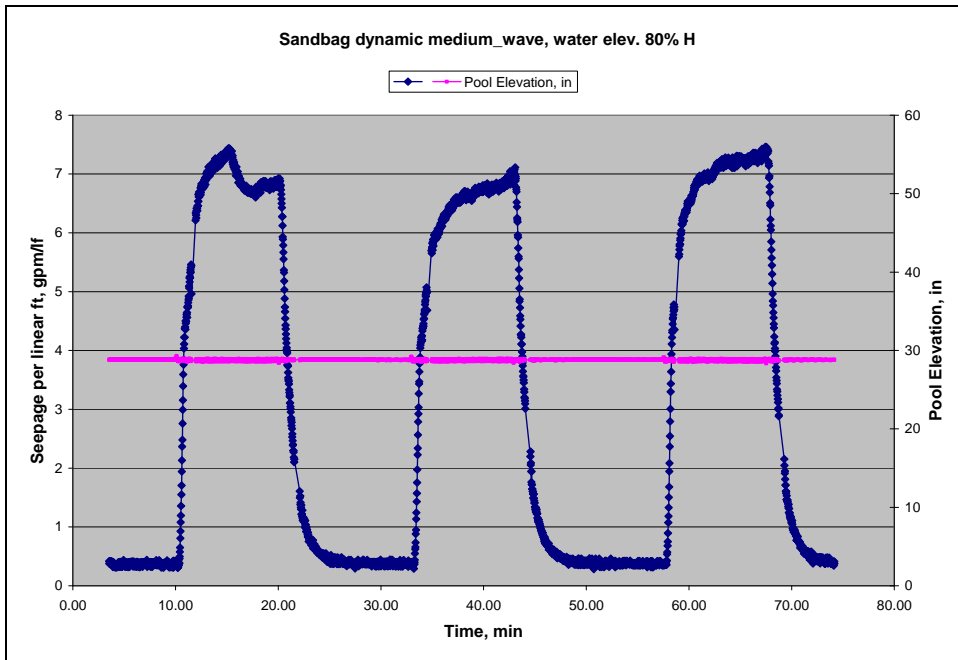

Figure 2-33. Seepage with dynamic testing at 80 percent levee height and 7- to 9-in. waves

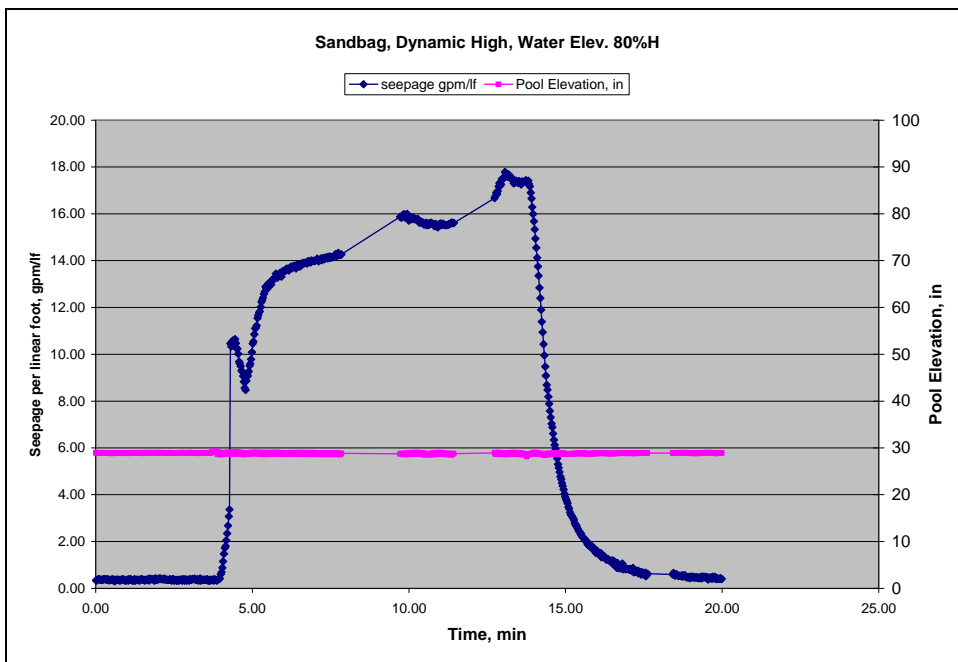

Figure 2-34. Seepage with dynamic testing at 80 percent levee height and 10- to 13-in. waves

10- to 13-in. wave test, reservoir level at 80 percent levee height. The water level in the reservoir on the pool side of the sandbag levee was held at a height 28.8 in., and wave heights were generated in packets of 10 to 13 in. for a period of 10 min.

Flow rate significantly increased from 0.37 to 17.52 gpm/ft due to overtopping of each wave front. No displacement was observed. Figure 2-34 shows extensive damage

occurred during this test requiring Repair 2. Repair 2 is discussed in the maintenance section of this chapter.

Debris impact test

During flood conditions, a levee may sustain damage from floating debris such as tree stumps, trees, houses, etc. Surviving impacts without immediate or progressive levee failure is vitally important. To simulate the effects of floating-debris impact, wood logs were mechanically rammed against the levee's outer (poolside) surface at a speed of 5 mph. The test protocol (overtopping test followed by impact tests) was modified for the sandbag levee to allow repairs due to significant levee damage during an initial overtopping test. After the barrier was repaired (Repair 1), the impact tests were completed prior to subsequent wave tests with pool at 80 percent of levee height.

Two separate impacts at 5 mph were conducted. The first test impacted a 12-in.-diam log 12 ft long against the levee during a static water level held at 66 percent of the levee height, and the second test impacted a 16-in.-diam log 12 ft long against the levee also at the 66 percent height.

The locations of impact are shown in Figure 2-35. The impact occurred at "e" for the 12-in. log and at "f" for the 16-in. log. No damage occurred from either log test, although the larger log left a small indentation on the barrier's front face. No permanent lateral displacement was observed during either test, and no vertical deformation was noted.



Figure 2-35. 12- and 16-in. logs at point of impact

Levee-overtopping test

To observe levee behavior where the floodwaters overtop and inundate the levee, an overtopping test was conducted. The reservoir pool height was raised beyond the height of the levee to allow overtopping to take place. During rising of the pool, numerous low spots along the crest allowed overtopping to occur in an uneven fashion. Water was to be raised to an elevation of 37.5 in., or until the pumps were unable to keep up.

However, the pool overtopped the levee at an elevation of 37 in. (approximately 1 in. above the crest), and continued for a period of 5.7 min. Progressive levee failure occurred as the total flow rate increased from 30.3 to 96.0 gpm/ft. A total flow rate of 2450 to 7,760 gpm is shown in Figure 2-36. Failure and results of failure are shown in Figures 2-37 through 2-40.

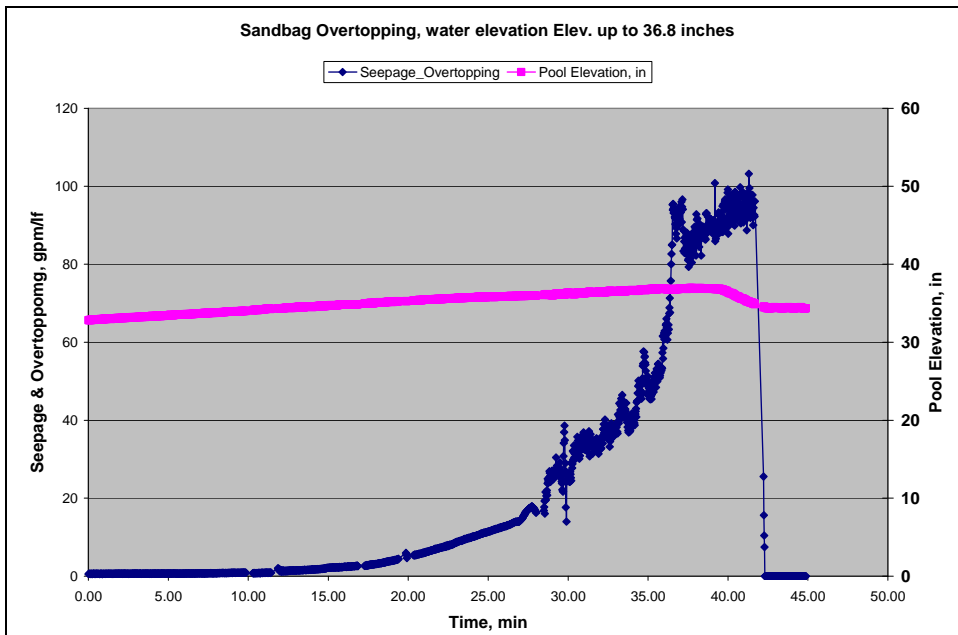

Figure 2-36. Seepage and overtopping

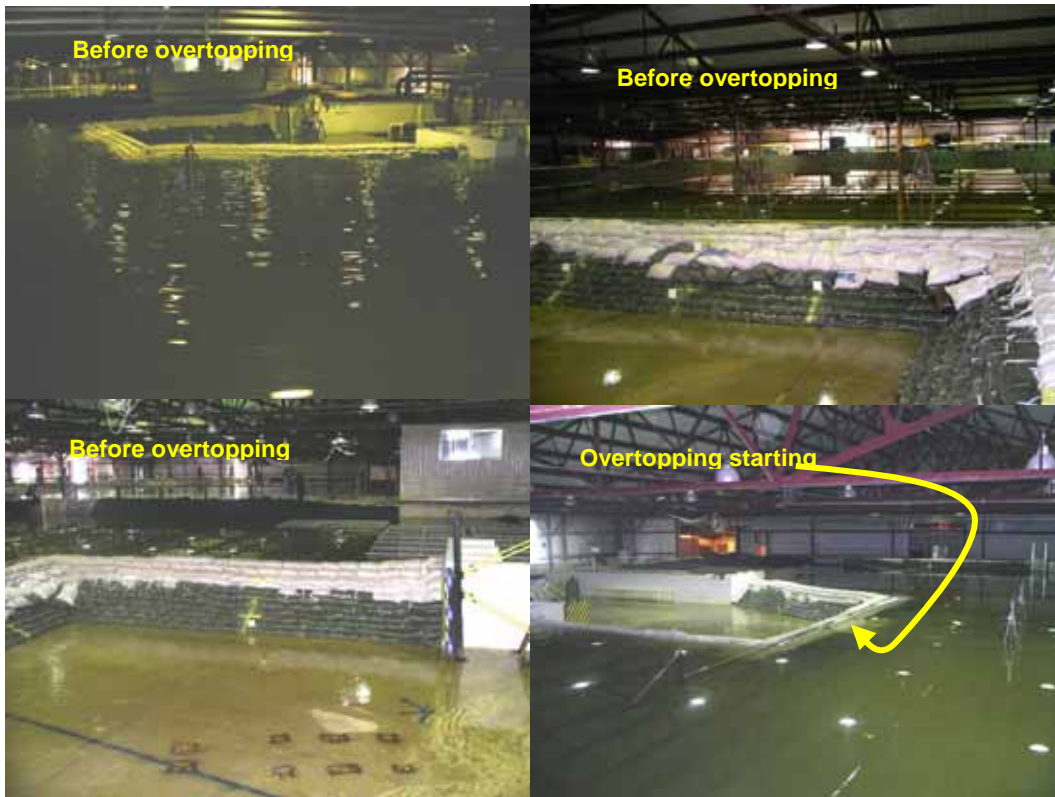

Figure 2-37. Sandbag levee prior to overtopping

The levee failed during overtopping before the pool elevation reached 37.5 in. The pumping rate continually increased until failure occurred. Thus, the structure failed before the test criterion was reached. Figure 2-37 shows the structure prior to testing. Figure 2-38 shows the progressive failure during overtopping. Figure 2-39 shows the sandbag levee after failure. The autopsy of Figure 2-40 shows that the bags became filled with water by the wave action and emptied as the sand flowed out like water (liquefaction). The wave action caused the untied bags to empty. Once the sandbags became light enough, the waves washed the bags from the levee causing failure. Some of the bags found on the landside were completely empty.



Figure 2-38. Sandbag levee progressive failure while testing



Figure 2-39. Sandbag levee after failure



Figure 2-40. Sandbag levee autopsy after overtopping

Maintenance and repair

Repair 1 was required to repair damage from the dynamic high-wave test performed with the pool at 66 percent of levee height. A four-man crew took 30 min (total time 2 man-hours) to remove damaged sandbags, reposition existing sandbags, and fill and place new sandbags on the pool side of the barrier. A Bobcat® with operator transported the new sandbags from the sand pile to the barrier.

The levee experienced damage at the center section. Sandbags were pulled back into the pool as the waves overtopped and water rushed back into the pool as the waves moved back toward the wave machine. Figure 2-41 shows the levee during the test, the damage after the test, and the levee after Repair 1.



Figure 2-41. Sandbag levee damage and levee after field repair 1

Repair 2 was needed after testing with the pool at 80 percent of levee height and 10- to 13-in. waves. A four-man crew took 30 min (total time 2 man-hours) to remove damaged sandbags and repair the barrier.

Overtopping caused by the 10- to 13-in. waves resulted in movement of individual sandbags in both directions from the crest of the structure. Figure 2-42a-d shows the progressive movement of sandbags during and after this test.

Figures 2-27 and 2-28 and accompanying text show and explain the failure that required rebuild. A four-man crew took 11 hr (total 44 man-hours) to repair the damage. The rebuild was required from calibration needed to establish the limiting wave forces for all future tests. For this reason, the rebuild is not considered part of the test repairs.



Figure 2-42. Damage to levee during the 10- to 13-in. waves, water at 80 percent of barrier height

Disassembly and reusability

After all tests were completed and the reservoir was drained, the levee was disassembled. Disassembly consisted of removing the sandbags and required a two-man crew with shovels, brooms, and a Cat® 916 front-end loader working a total of nine man-hours.

The sandbags were broken and torn during removal and were not fit to be used again. The sandbags were piled into one large stack, similar to that seen in real-world flood fights. The equipment and sandbag pile can be seen in Figure 2-43.



Figure 2-43. Heavy equipment used to disassemble sandbags and waste sandbags

Environmental aspects

The only material used (sand) is considered to be nonhazardous and nontoxic, so there were no exposure hazards during these tests.

If the floodwater is contaminated with bacteria or pollutants, the sand fill inside the bags also may be contaminated. The sandbag itself should provide some filtering protection, especially for nonwater-soluble and small contaminants such as floating oil, but water-soluble contaminants would likely seep into the sand fill.

Hesco Bastion Concertainer® Levee Tests

Design

Hesco Bastion Concertainer® (hereinafter referred to as “Hesco®”), listed under U.S. Patents 3333970, 5472297, and European Patent 046626, is a structural system of linked baskets containing fill material. Hesco® systems have been used around the world for military operations as well as for combating natural disasters (Hesco 2004). The corporate Web site is <http://www.hesco-usa.com>.

The units (Figure 2-44) are manufactured in various sizes and are made of welded galvanized steel mesh that is assembled with coiled joints. A polypropylene nonwoven geotextile liner retains the fill material (sand, gravel, or other fill) that is dumped into the open (top and bottom) basket using minimal labor and commonly available equipment. The baskets are flat-packed on pallets, extended and joined with joining pins, filled with fill material, and stacked in various configurations depending on the end-use. The units are lightweight, portable, and are easily handled.

Engineering analysis of the system was provided by Hesco®, and listed the ability of the structure to withstand hydrostatic and uplift forces. The ability of the structure to resist lateral forces was analyzed based on the assumption that the structure will respond as a rigid body to hydrostatic forces. A free-body diagram of the hydrostatic forces showed the resistance to lateral sliding on a concrete floor with a given water height of 3 ft and a coarse-grained fill material.

A test-condition analysis for a 3-ft by 3-ft unit on a concrete floor subjected to a 3-ft-high flood was given for various load cases with given basket and fill weights, given sand unit weight, vertical and horizontal reaction forces, hydrostatic pressure force, and uplift force. Assuming an interface coefficient of friction between coarse sand and concrete floor of 0.45, the safety factor against lateral sliding was calculated to be 1.13 (Load Case 5). No floor anchoring system was accounted for, and no floor anchoring was planned for the ERDC tests.



Figure 2-44. Hesco Bastion Concertainer® basket units, assembled and empty

For the ERDC tests, the Hesco® Flood Unit system (General Services Administration (GSA) No. GS-07F5369P) was furnished, with unfolded unit dimensions of 3 ft height by 3 ft depth by 12 ft width, and commercial price of \$295 per unit (approximately \$25 per linear foot). End panels (3 ft × 3 ft × 3 ft), connecting joining pins (3 ft) and connecting coil hinges (3 ft) were also furnished. The wire mesh, joining pins, and coil hinges were manufactured from 8-gauge steel and coated with a proprietary galvanizing. Wire mesh size was 3 in. by 3 in. The nonwoven geotextile liner was GEOTEX® 641. Fill sand was provided by ERDC (delivered price of \$7 per cubic yard) and was classified as poorly graded sand (USCS “SP”) with approximate moisture content of 6 percent.

Construction

Layout of the Hesco® levee built at the ERDC test facility is shown in Figure 2-45.

The stacked units were shipped to the laboratory on a wooden pallet. Construction commenced on 4 May 2004. Relatively cool ambient air temperatures (approximately 60 to 70 deg) provided comfortable working conditions inside the hangar.

Personnel needed to construct the levee included a Hesco® supervisor and four laborers unfamiliar with the product. A 5-min training session commenced (Figure 2-46), the supervisor handed out gloves to the workers, and they began unloading and expanding the units onto the concrete floor (Figure 2-47).

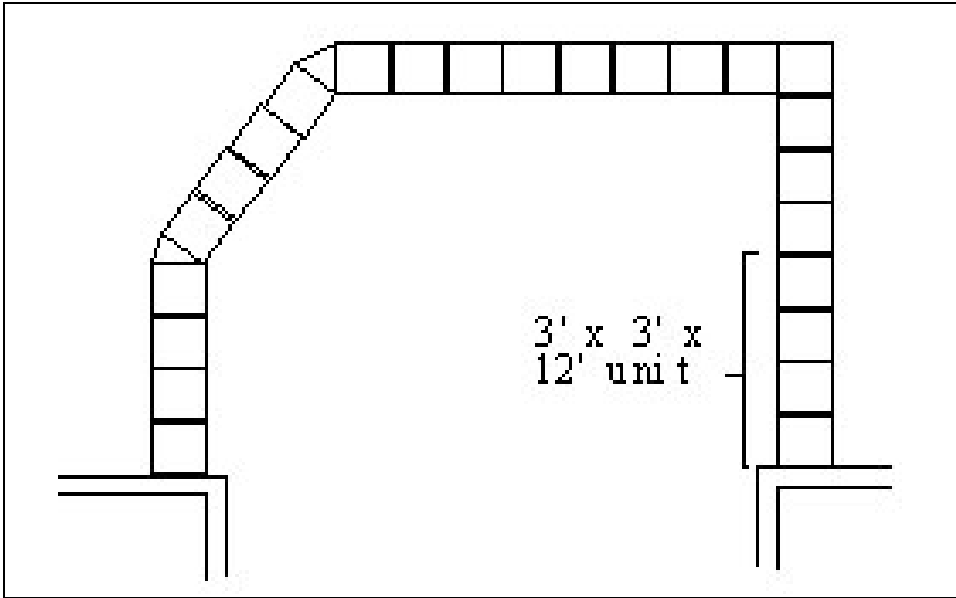

Figure 2-45. Hesco® levee layout

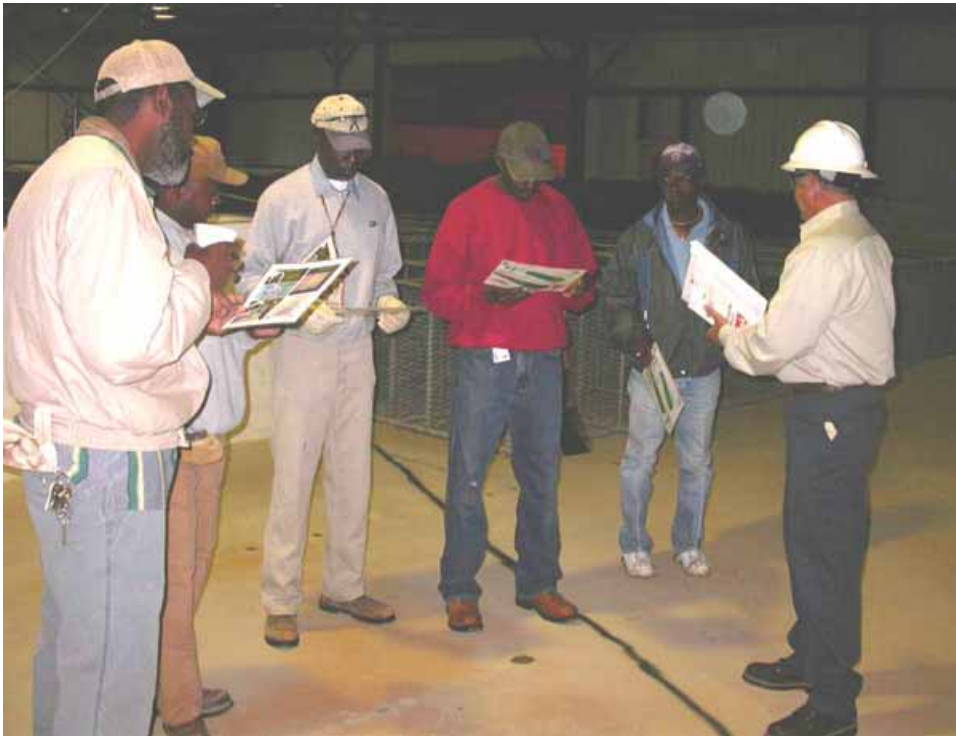

Figure 2-46. Training session for Hesco® assembly team



Figure 2-47. Expanding and positioning units

The expanded units were sequentially positioned on the layout footprint, and the coil hinges were fastened together with the joining pins (Figure 2-48). At angled connections (the intersection of the left and center walls), the supervisor folded and attached end panels to achieve proper unit geometry (Figure 2-49), and the workers continued pinning the units together. Nylon cable ties were also used for securing units together at critical locations determined by the supervisor (Figure 2-50). Initial treatments at concrete wall abutments were also installed (Figure 2-51). Total installation time for offloading, laying out, aligning, and connecting the levee structure was 60 min (approximately 1 lft/min).

The next construction phase consisted of filling the units with sand and completing the installation. The bottom flaps were flattened against the concrete floor (Figure 2-52). A front-end loader top-dumped sand into each unit (Figure 2-53). The supervisor and four workers continued securing the units, filling with sand, compacting, and leveling sand within the units with shovels while the sand-fill operation was ongoing, until all units were full and leveled (Figures 2-54 through 2-57). Approximately 24 cu yd of sand was required to fill the units.

No floor anchoring system was used at the concrete wall abutment connections. To seal the joint between the unit and the concrete wall abutment, expandable foam was dispensed into the joint by the supervisor (Figures 2-58 and 2-59).

Total installation time for the Hesco® levee was 3.5 hr (approximately 3.4 min per linear foot of levee). Labor required was a six-man crew (total 20.8 man-hours), and equipment required was a Cat® 916 front-end loader, sand, and aerosol foam. On a linear foot basis, the construction required 20.8 man-hours per 62 lft (measured along the protected toe), or 0.3 man-hours per linear foot.



Figure 2-48. Pinning units together



Figure 2-49. Top view of angled unit at intersection of left and center walls



Figure 2-50. Cable ties at joint connections



Figure 2-51. Right concrete wall abutment



Figure 2-52. Securing flaps against concrete floor. Note center coils which are prefastened at factory



Figure 2-53. Filling with sand



Figure 2-54. Shoveling sand into unit



Figure 2-55. Leveling and compacting sand within each unit



Figure 2-56. Filled with sand, view from left concrete wall abutment



Figure 2-57. View from pool side



Figure 2-58. Sealing concrete wall abutment with aerosol foam



Figure 2-59. Expanded foam at abutment with concrete wall

Prior to filling the reservoir to begin the hydrostatic tests, laser targets were positioned in the levee walls and sealed with expandable foam (Figure 2-60). The completed structure was instrumented with the center-wall displacement monitoring system and was readied for static testing (Figure 2-61). The vendor representative agreed in writing that the levee had been constructed properly and was ready for testing.

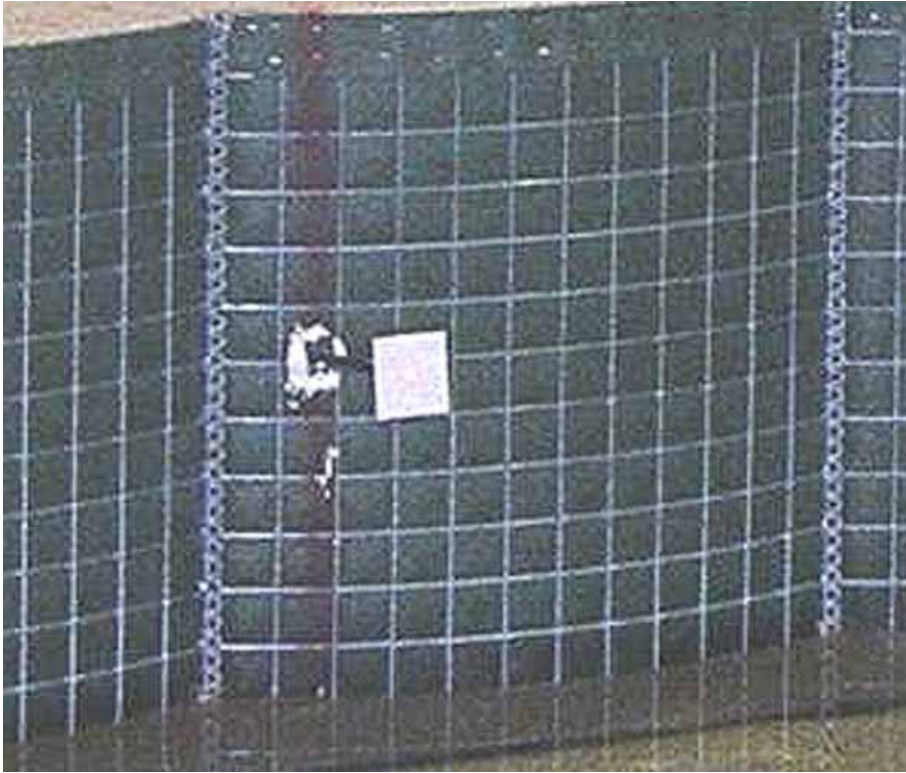

Figure 2-60. Laser target



Figure 2-61. Center wall displacement monitoring system

Performance

Testing of the Hesco barrier began after construction was completed and was documented in the same manner as testing of the sandbag structure. Three minor repairs were allowed within seven windows of opportunity during the tests, as described in Appendix C. After the overtopping test, one final repair (or rebuild) was allowed prior to the impact tests.

Disassembly and removal of the barrier was performed after testing was completed and the test basin was drained. An environmental evaluation was also performed for the barrier system, to assess environmental hazards of construction and disposal.

Hydrostatic head tests

The pool elevation was raised to three different elevations for a minimum of 22 hr at each predetermined elevation. During the testing period, levee movement and seepage values were recorded. During and after each test the levee was inspected for weakness and/or failure before the pool elevation was raised to the next level.

Hydrostatic head test, 1-ft reservoir (33 percent height). The water level in the reservoir on the pool side of the levee was raised to a height of 1 ft (33 percent of the levee height). Seepage flow rate ranged from 0.36 to 0.42 gpm/ft (Figure 2-62), and no displacement was observed. Most of the flow rate was observed coming from the wall corners, and the vertical joint between unit ends.

Figure 2-63 shows the wetting front observed on top of the structure as the water saturated the dry sand. Figure 2-64 is a close-up of seepage occurring at a vertical joint between units.

Hydrostatic head test, 2-ft reservoir (66 percent height). The water level in the reservoir on the pool side of the levee was raised to a height of 2 ft (66 percent of levee height). Seepage flow rate ranged from 0.90 to 0.97 gpm/ft (Figure 2-65), and no displacement was observed. Most of the flow was observed coming from the wall corners and the vertical joint between unit ends. Figure 2-66 shows the structure from the front.

Hydrostatic head test, 3-ft reservoir (95 percent height). The water level in the reservoir on the pool side of the levee was raised to an approximate height of 34 in. (95 percent of levee height). Seepage flow rate ranged from 1.76 to 1.86 gpm/ft (Figure 2-67). Lateral displacement ranged from 3 to 9 mm. Vertical deformation was observed to range from 0.24 to 2.28 in., and was assumed to be a result of units “barreling” as the sand became completely saturated. Most of the flow was observed coming from the wall corners and the vertical joint between unit ends.

Hydrodynamic tests

The testing protocol specified that packets of monochromatic waves with a wave period $T = 2.0$ sec would be generated to impact the levee hydrodynamically. Tests were performed at two different pool elevations (66 percent and 80 percent of levee height). At the 66 percent height, 3-in. waves (measured from trough to crest) were generated continuously for a period of 7 hr. Waves ranging from 7 to 9 in. were then allowed to impact the structure a total of 30 min (three 10-min intervals with 15 min calming periods between). Next, wave heights ranging from 10 to 13 in. were allowed to impact the structure for 10 min. The water was then raised to a level of 80 percent levee height and the tests were repeated. At the end of each 10-min increment of wave testing (excluding the 7 hr of 3-in. waves), the testing basin was stilled for up to 45 min to allow the waves to dissipate.

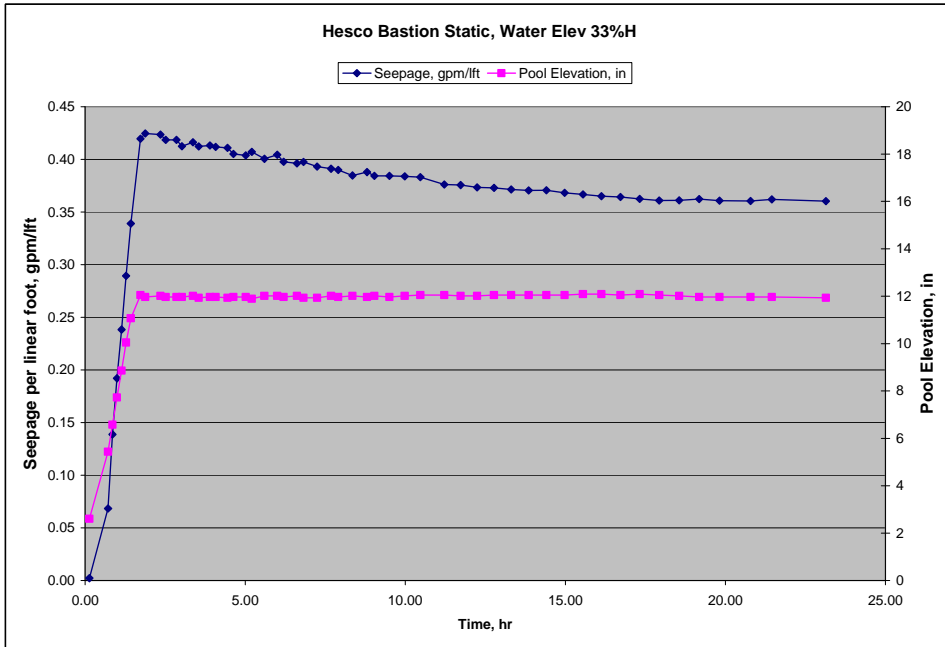

Figure 2-62. Seepage-flow rate per linear foot at 1-ft pool elevation (33% H)



Figure 2-63. View of left wall water saturation



Figure 2-64. Close-up of seepage through vertical joint between units

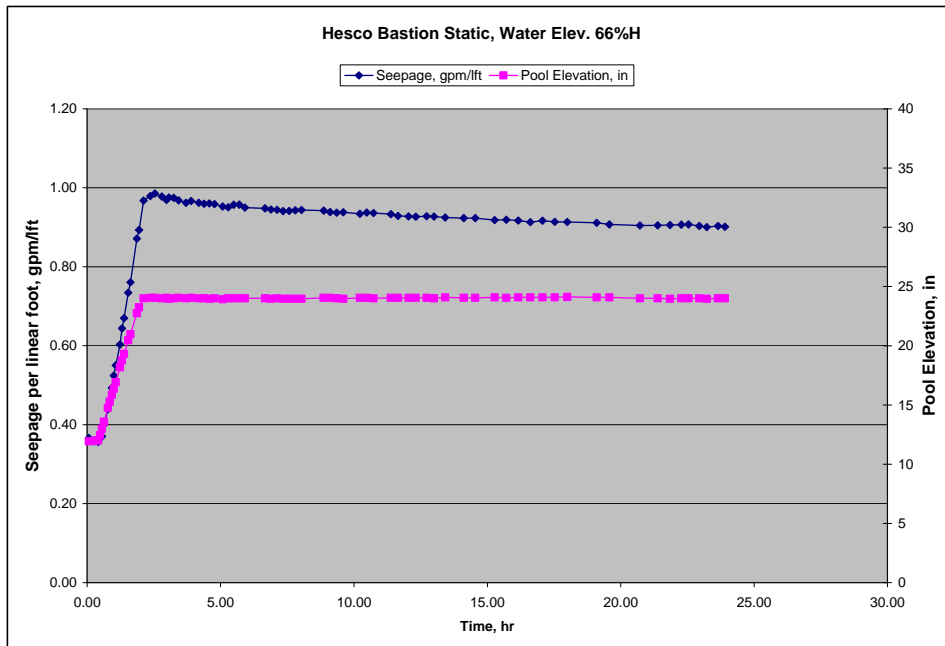

Figure 2-65. Seepage flow rate per linear foot at 2-ft pool elevation (66% H)



Figure 2-66. View from front

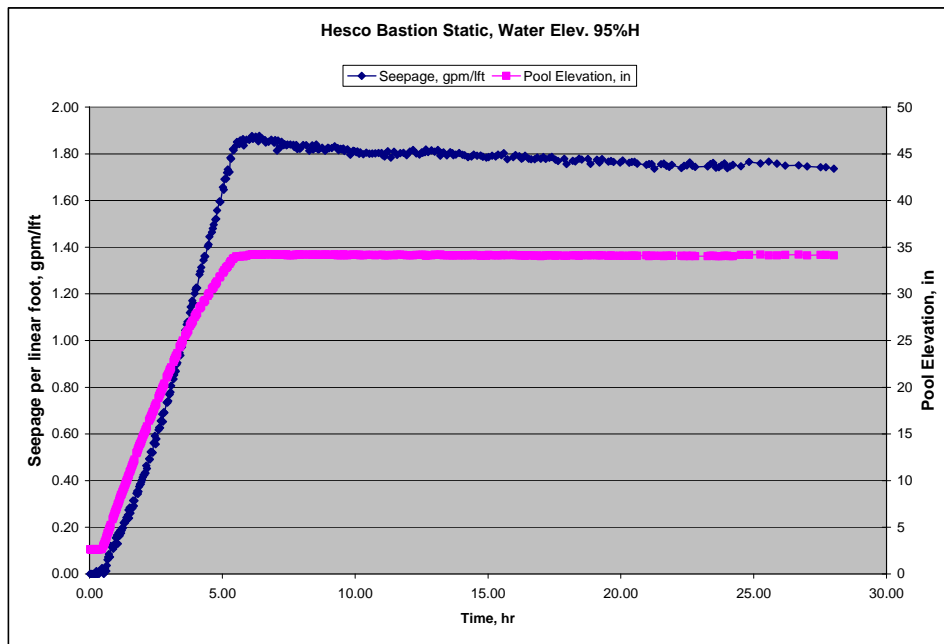

Figure 2-67. Seepage flow rate per linear foot at 95 percent pool elevation

3-in. wave test, reservoir level at 66 percent levee height. The water level in the reservoir of the levee was lowered from the 95 percent level to a height of 24 in. within an interval of about 2 hr. The wave generator was activated and the waves began to impact the levee. Flow rate was observed to range from 0.81 to 0.83 gpm/ft (Figure 2-68), with no displacement. No wave overtopping was observed. Figure 2-69 is a view of the left wall and center wall intersection showing seepage at the wall base.

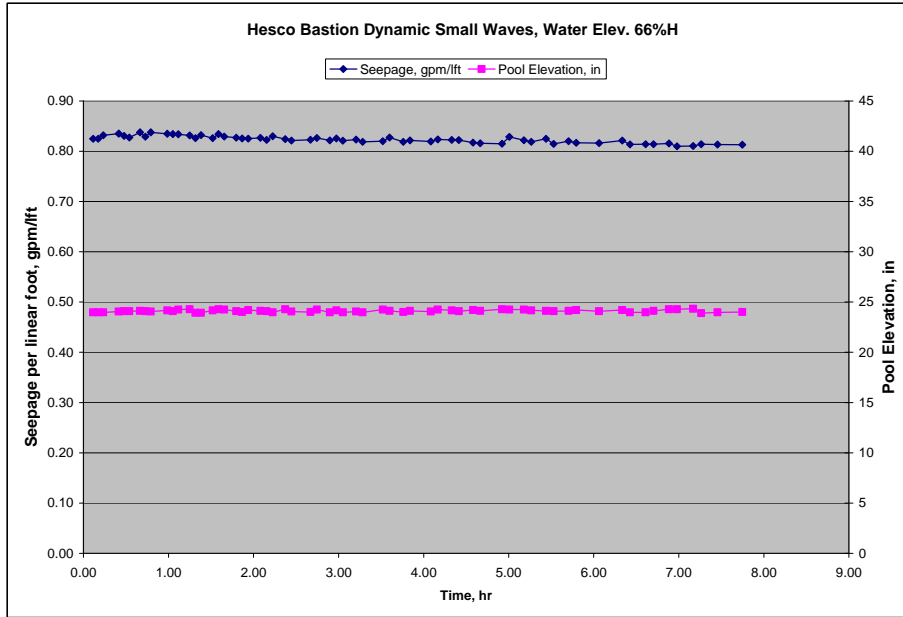

Figure 2-68. Seepage flow rate per linear foot, small wave at 66 percent pool elevation

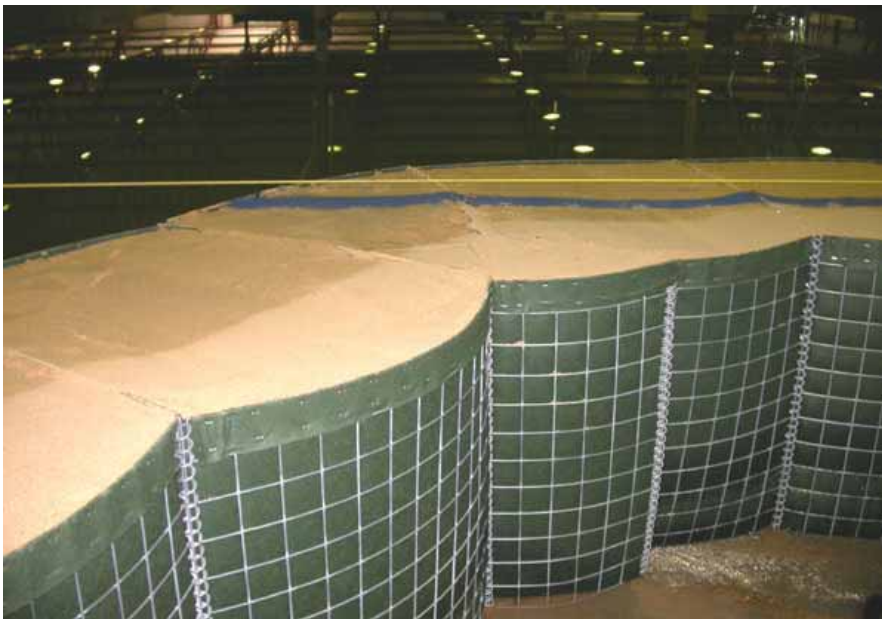

Figure 2-69. Left wall and center wall intersection

7- to 9-in. wave test, reservoir level at 66 percent levee height. The water level in the reservoir on the pool side of the levee was held at a height of 24 in., the wave generator was activated, and the waves began to impact the levee. Flow rate was observed to subside within a range of 0.77 to 0.78 gpm/ft (Figure 2-70), with no levee displacement. No wave overtopping was observed.

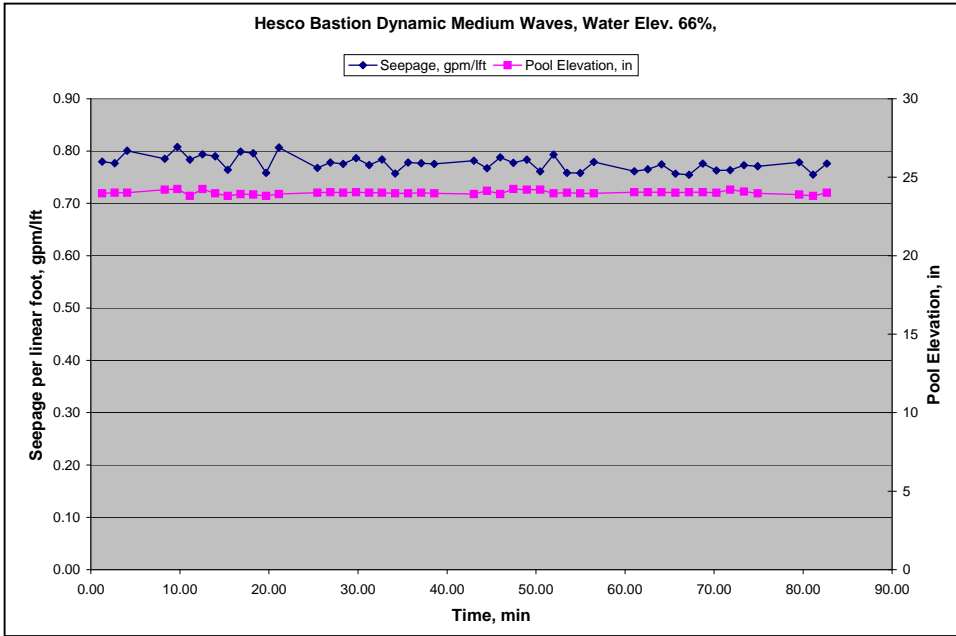

Figure 2-70. Seepage flow rate per linear foot, medium wave at 66 percent pool elevation

10- to 13-in. wave test, reservoir level at 66 percent levee height. The water level in the reservoir on the pool side of the levee was held at a height of 24 in., the wave generator was activated, and the waves began to impact the levee. Flow rate was observed to range from 0.78 to 0.98 gpm/ft (Figure 2-71), with no displacement. Minor sporadic wave overtopping was observed, primarily along the center wall (Figure 2-72).

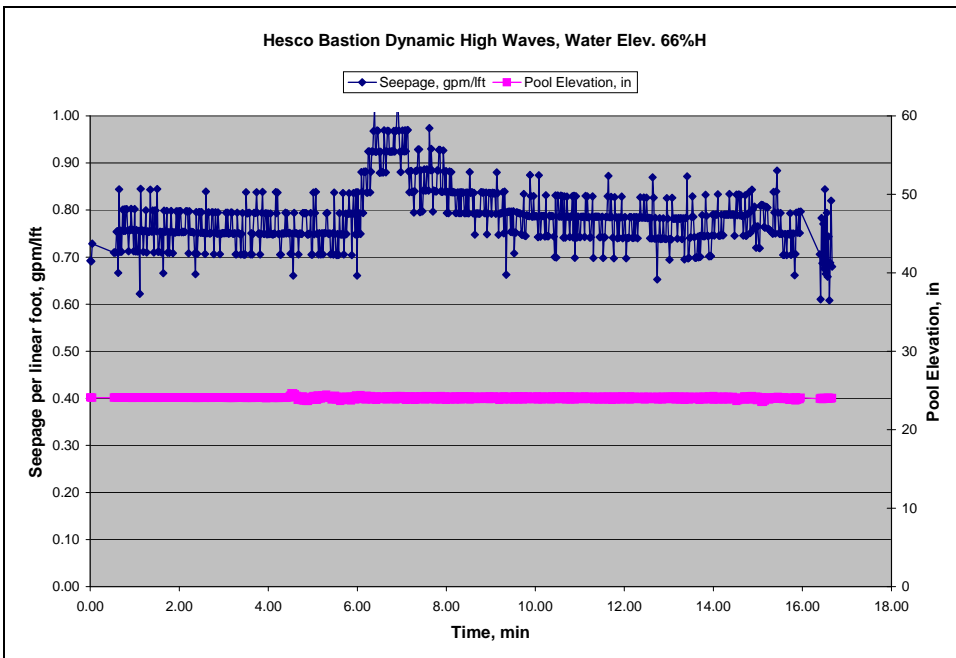

Figure 2-71. Seepage flow rate per linear foot, high wave at 66 percent pool elevation



Figure 2-72. Center wall wave-induced erosion

At the conclusion of the test, sand had eroded and settled from the top of the center wall (Figure 2-73), and a solution was devised to prevent further erosion during subsequent testing. As shown in Figures 2-74 and 2-75, a tarp covering was placed on the wall top and secured with cable ties.



Figure 2-73. Sand eroded from top of center wall



Figure 2-74. Covering top of wall with tarp to prevent further erosion



Figure 2-75. Securing with cable ties

3-in. wave test, reservoir level at 80 percent levee height. The water level in the reservoir on the pool side of the levee was raised to a height of 29 in., the wave generator

was activated, and the waves began to impact the levee. Flow rate was observed to range from 1.03 to 1.04 gpm/lft (Figure 2-76), with no displacement. No wave overtopping was observed. Figure 2-77 shows seepage under the center wall base.

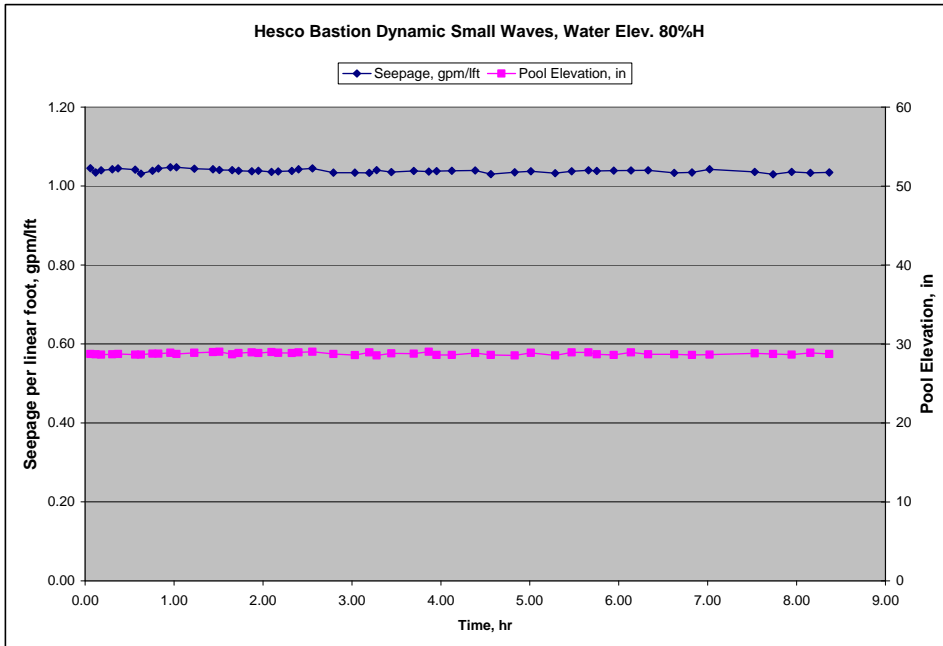

Figure 2-76. Seepage rate per linear foot, small wave at 80 percent pool elevation



Figure 2-77. Seepage at vertical joint and wall base

7- to 9-in. wave test, reservoir level at 80 percent levee height. The water level in the reservoir on the pool side of the levee was held at a height of 29 in., the wave generator was activated, and the waves began to impact the levee. Flow rate was

observed to range from 1.03 to 1.07 gpm/ft (Figure 2-78), with no displacement. No wave overtopping was observed. Figure 2-79 shows a view of the structure.

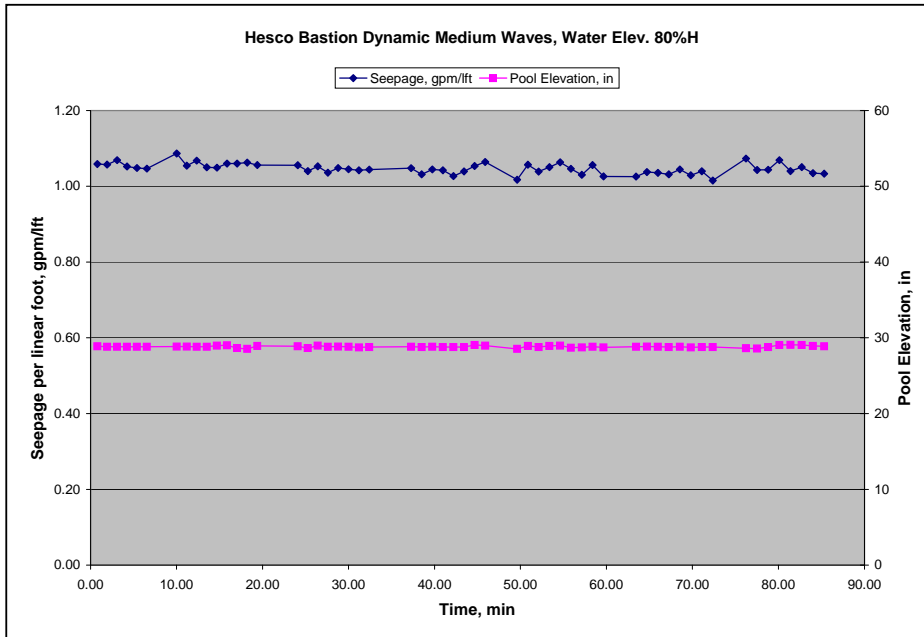

Figure 2-78. Seepage flow rate per linear foot, medium wave at 80 percent pool elevation



Figure 2-79. View of left and center walls

10- to 13-in. wave test, reservoir level at 80 percent levee height. The water level in the reservoir on the pool side of the levee was held at a height of 29 in., the wave generator was activated, and the waves began to impact the levee. Flow rate was observed to range from 1.05 to 3.14 gpm/ft (Figure 2-80), with no displacement. Wave overtopping was observed at each wave front, which contributed to the significant flow rate increase. Figure 2-81 shows wave overtopping.

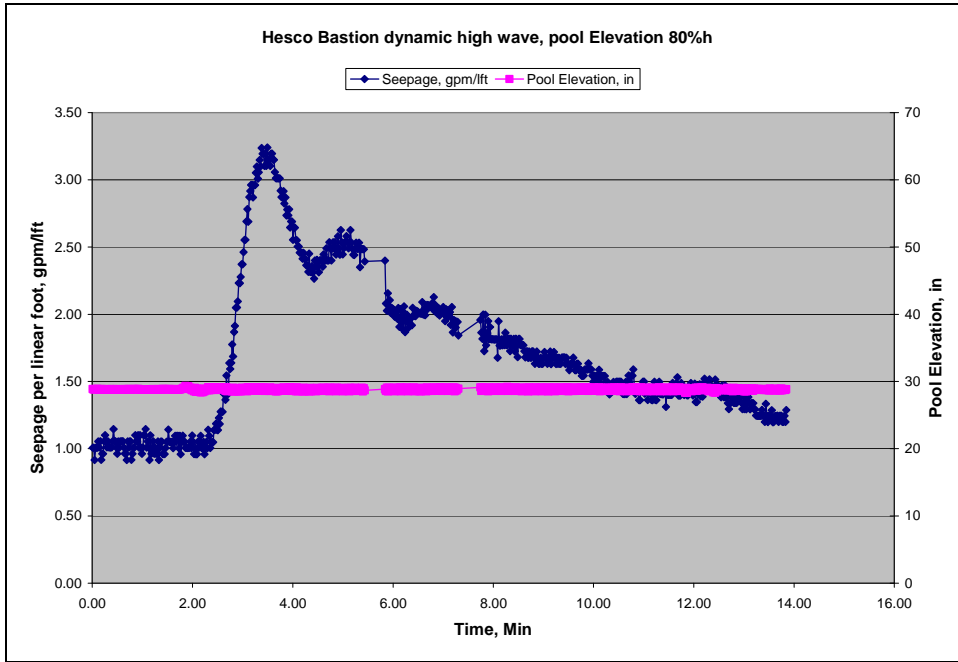

Figure 2-80. Seepage flow rate per linear foot, high wave at 80 percent pool elevation



Figure 2-81. Wave overtopping along center wall

Levee-overtopping test

The reservoir level was raised from a height of 37.6 in. to a height of 38.8 in. After the water level reached the top of levee, overtopping occurred. The structure successfully

withstood overtopping without failure. Overtopping water combined with seepage water to increase the measured flow rate within a range of 25.2 to 35.0 gpm/ft (1,800 to 2,500 gpm) in the span of 1 hr as shown in Figure 2-82. The overflow was uniform due to the uniform levee height. Figures 2-83 and 2-84, show the overtopped levee.

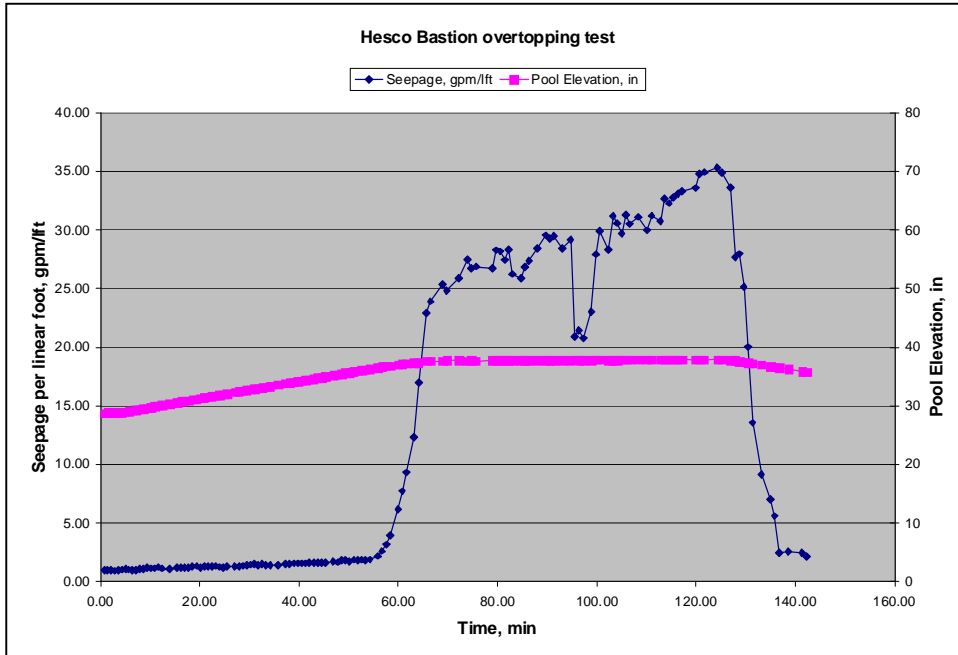

Figure 2-82. Seepage flow rate per linear foot during overtopping



Figure 2-83. Overtopped levee structure, view from right wall



Figure 2-84. Overtopped levee structure, view from left wall

Debris impact test

With reservoir level at 24 in., the log impact tests were begun. The 12-in. log impacted the structure and bounced back without causing noticeable damage. The structure displaced slightly and recovered to its original position. The 16-in. log impacted the structure and bounced back also without causing any noticeable damage. The structure displaced slightly and recovered to its original position, but vertical deformations of the sand fill ranging from 4.02 to 0.72 in. were noted. Figure 2-85 shows the minor change in seepage flow rate during impact testing and Figure 2-86 shows the area where the logs hit, viewed from the pool side.

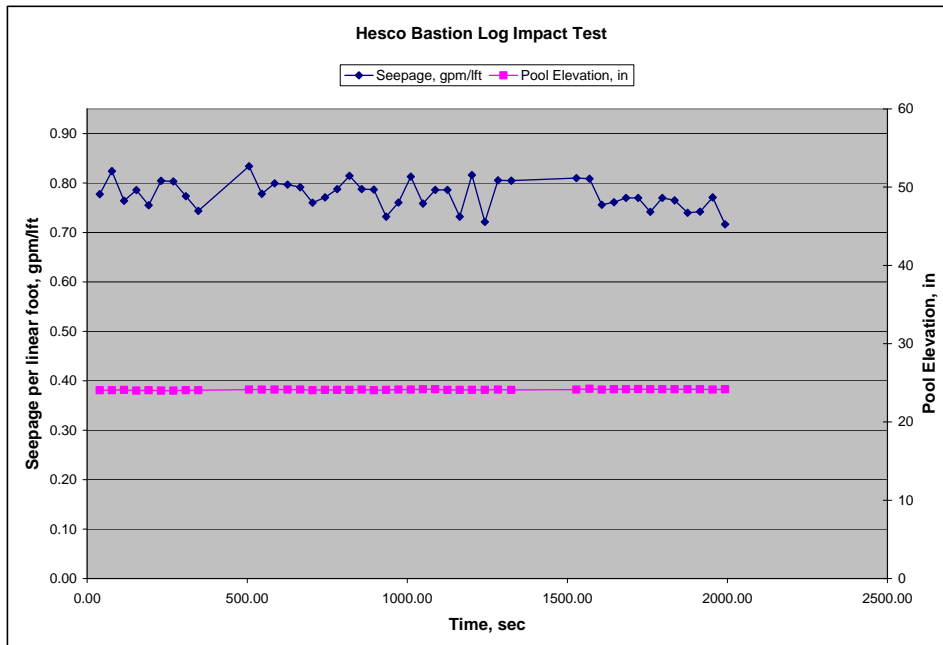

Figure 2-85. Seepage flow rate per linear foot during impact tests



Figure 2-86. Log impact zone on center wall, pool side

Maintenance and repair

Repair 1 was performed prior to the 80 percent small (2- to 3-in.) wave test. It consisted of adding a top membrane fabric over the units, and adding cable ties and wire ties. A four-man crew took 24 min (1.6 man-hours) to do this work. Figure 2-87 shows this work (see also Figures 2-74 and 2-75).

Repair 2 was performed prior to overtopping. It took three men 5 min (0.25 man-hours) to add prefilled sandbags on the pool side for additional protection against joint seepage (Figure 2-88). Repairs 3 and 4 were not needed.



Figure 2-87. Repair 1, view along right wall



Figure 2-88. Added sandbag along left wall

Disassembly and reusability

At test conclusion, with a dry concrete floor, the Hesco® levee was disassembled and removed from the test facility on 24 May 2004. Disassembly consisted of three laborers and a supervisor to unpin the units, and a Cat® 916 front-end loader with operator to remove the sand. This five-man crew took 2 hr and 41 min (total 13.4 man-hours) to disassemble and remove the levee.

Disassembly consisted of removing all cable ties, removing the top cover (Figure 2-89), unhinging the inner and outer walls held with pins in each center partition (Figures 2-90 and 2-91, manually pulling each wall apart (Figures 2-92, 2-93, and 2-94), removing the sand pile (Figure 2-95), and restacking the units onto a pallet (Figure 2-96).

The sand was stockpiled for reuse, and the folded units were placed on wooden pallets for reuse. The only nonreusable items were the fabric panels at either end of the 12-ft units. During disassembly, the panels were slit with a knife to facilitate separation after the center partition pin was pulled out. The fabric end panels would then be repaired or replaced prior to reuse.



Figure 2-89. Cutting cable ties and removing top cover



Figure 2-90. Preparing to remove center partition pin



Figure 2-91. Removing center partition pin



Figure 2-92. Preparing to pull unit apart



Figure 2-93. Pulling unit apart



Figure 2-94. Outer wall removed from one unit on right wall



Figure 2-95. Removing sand pile



Figure 2-96. Stacked units ready for reuse

Environmental aspects

From an environmental standpoint, when the HESCO Bastion Concertainer is used as designed, the barrier does not present any threats to the environment. Material Safety and Data Sheets provided by Hesco® indicated no exposure hazards due to everyday usage of the construction materials. The wire baskets are constructed from galvanized steel. If modifications are made to the baskets that involve welding of the wire mesh, then precautions should be made to prevent inhalation of the particulates created while welding. The baskets are constructed primarily of iron, greater than 90 percent, but do contain other metals, less than 3 percent, such as chromium, copper, manganese, nickel, and zinc. Since some of these metals are considered carcinogens, some form of respiratory protection should be used when welding the baskets.

Sand is placed in the baskets using machinery such as front-end loaders or bobcats. This machinery can damage the soil or foundation around the structure. Care should be

taken when filling the baskets so that minimal damage is done to the area around the structure and repairs should be made to prevent erosion.

While being used as a flood barrier, the HESCO Bastion Concertainer does not pose any environmental hazards. Upon completion of the use of the barrier there are several issues that need to be addressed to ensure that no environmental hazards occur. Should the floodwater be contaminated with waterborne bacteria or pollutants, it may be possible for the sand fill inside the units to also become contaminated. The outer fabric should provide filtering and physical barrier protection, especially for nonwater-soluble contaminants such as floating oil, but water-soluble and suspended contaminants would likely be adsorbed by the sand fill. Should the levee materials (fabric and/or sand) become contaminated due to flood water contaminants, measures to properly decontaminate and/or dispose of those materials would be necessary. Like the sandbag structure, the sand used to fill the basket does not pose an environmental threat and should be disposed of in the appropriate manner. If the floodwater was contaminated the sand would have to be tested before disposal. The geotextile filter cloth would probably filter out most of the fine soil particles where most of the contamination is found. Still the sand would have to be tested to ensure no contaminants were in the sand that could present an environmental hazard. The filter cloth would have to also be disposed of in an appropriate manner. The wire baskets present the most danger to wildlife if left in the field. Small animals could become trapped in the mesh if left in the field. Also, if the baskets are left where water covers them, fish could become trapped in the mesh, similar to any other wire debris present in water bodies.

RDFW® Levee Tests

Design

The Rapid Deployment Flood Wall (RDFW®) was originally developed from the concept of expandable plastic grid system (“sand grid”) which was invented at ERDC-GSL in the 1980s (U.S. Patent 4,797,026). The original RDFW® proponents licensed the sand grid patent from the Corps and developed a refined version of the technology which was later researched at ERDC with a Cooperative Research and Development Agreement (CRADA) in 1996.

The RDFW system is commercially available through the Geocell Systems Corporation (<http://www.geocellsystems.com>) and is also sold through the GSA procurement schedule #GS-07F-0340M, with a unit price of \$100 (Geocell 2004). Figure 2-97 is a sketch of the unit grid dimensions. Each unit is a modular, lightweight, and collapsible plastic grid that allows for several stacking configurations and connections. The plastic material is a polyester polymer manufactured by Eastman Inc. (Estar™ copolyester 5445).

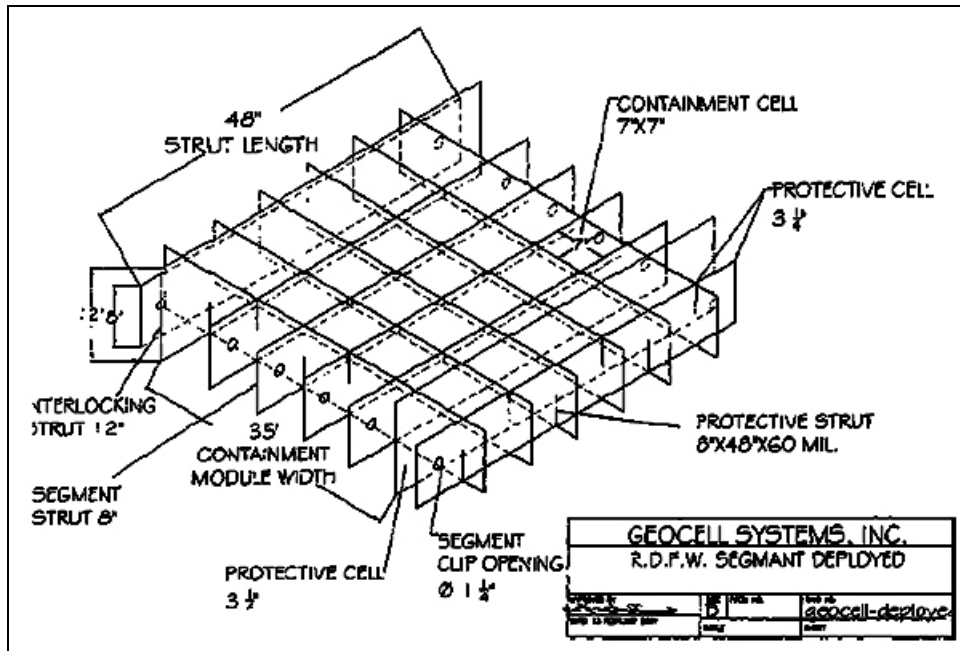

Figure 2-97. RDFW® grid unit (from Geocell Systems Web site)

The 4-ft by 4-ft by 8-in. high grid units are laid side by side and interlocked. Vertical stacking allows additional height capacity. Once the desired grid geometry is achieved, the grid units are filled with sand. The sand achieves compressive strength and provides the mass to resist sliding forces and overturning moments. The sand used in this experiment was the same used for the other levee structures, with a soil classification of poorly graded (SP) sand.

Engineering analysis of unit capabilities as a function of wall height was provided by RDFW®. The sliding resistance was given as a function of the sand fill's coefficient of friction and wall height. Given a sand density of 120 lb/cu ft and friction angle of 38 deg, the ultimate resistance of a 4-ft high by 4-ft wide RDFW® wall was presented as 1,310 lb/ft. Capacity to resist a lateral slide load such as a mudslide was presented. Capacities to resist dynamic energy absorption and dynamic energy impact loads at varying back slope angles and wall heights also were presented. Safety factor for a hydrostatic load imposed by a 3-ft flood against a structure on a concrete floor was not listed. Analyses for base anchor pins were provided, but floor anchoring was not conducted for the ERDC laboratory tests.

Construction

Installation at the test facility was initiated with a six-man crew. Relatively cool air temperatures in the mornings (approximately 70 deg) provided comfortable working conditions inside the test facility hangar. To provide comfort during the slowly-rising afternoon heat (approximately 80 deg), fans were placed in the work area, and water and electrolytic fluids were made available to all workers and those observing the levee construction.

The grid units were taken out of the storage box, expanded, and placed on the concrete floor. The layout is shown in Figure 2-98.

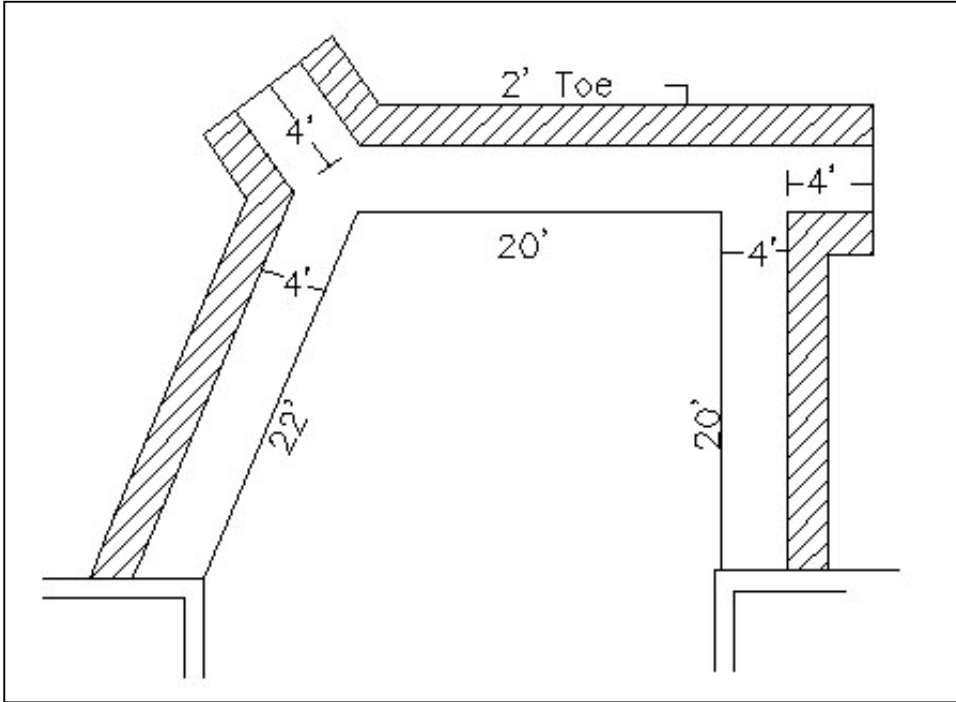

Figure 2-98. RDFW® levee layout

After a short training session, the grid units were sequentially placed on the floor and interlocked from the left concrete wall abutment to the right concrete wall abutment. Figures 2-99 through 2-103 show the grid unit sequence.

Figure 2-104 shows the first-layer installation at the left abutment wall. Figure 2-105 shows the 60-deg wall angle intersection of the left and center walls, with the buttress wall on the pool side. Figure 2-106 shows the typical method for grid unit connections.

The grid units were connected sequentially in a single layer at the time. Figures 2-107 through 2-112 show grid installation details. Arrangements for nonperpendicular intersections were made at the left concrete wall abutment and the left wall/center wall intersection. A buttress wall was installed extending into the pool side from the left wall/center wall intersection. A buttress wall was also installed at the perpendicular intersection of the right wall and center wall, and also extended into the pool.

A single-layer grid unit was added at the wall toe on the pool side. The toe extended from the left concrete wall abutment to the left wall buttress. It continued from the left wall/center wall buttress to the outside edge of the center wall/ right wall buttress, and resumed along the right wall to the right concrete wall abutment (Figure 2-111).



Figure 2-99. Pallet containing grid units



Figure 2-100. Training session



Figure 2-101. Removing and preparing to expand a grid unit



Figure 2-102. Laying expanded grid unit on floor



Figure 2-103. Connecting two grid units together



Figure 2-104. Left concrete wall abutment, viewed from protected side

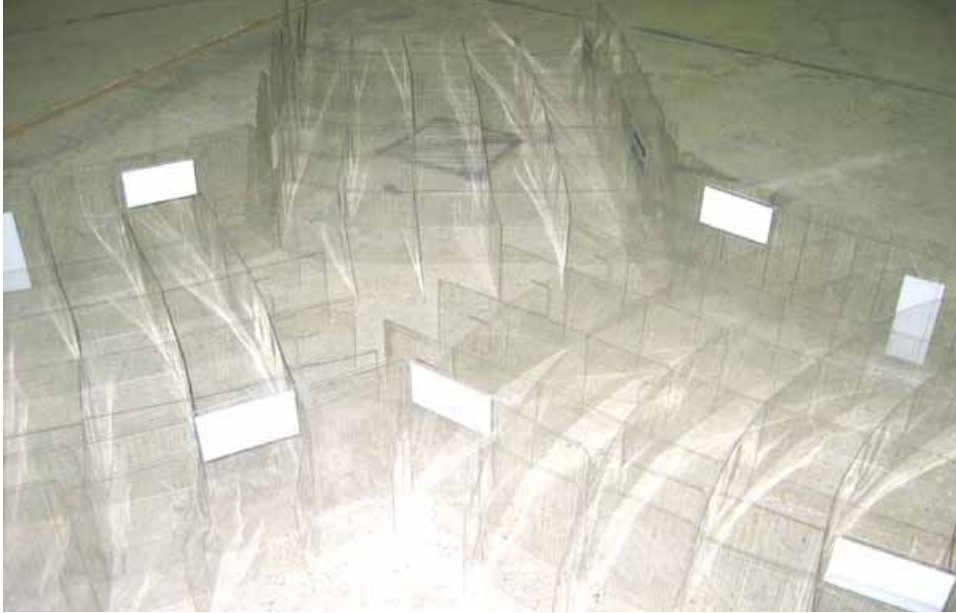

Figure 2-105. Intersection of left and center walls, viewed from protected side



Figure 2-106. View of grid unit connection method



Figure 2-107. Connecting right wall to center wall grid cells, viewed from pool side



Figure 2-108. Beginning second grid layer from right concrete wall abutment



Figure 2-109. Third grid unit layer at right wall and center wall junction, viewed from pool side



Figure 2-110. Top (fourth) grid layer installed along center wall/left wall buttress as viewed from pool side



Figure 2-111. Installation of toe grid on pool side of right wall



Figure 2-112. Completed grid installation (including toe grid) on left wall

After the grid units were installed in four layers to a cumulative height of 32 in., the team began filling units with sand. A front-end loader delivered sand from the stockpile to fill the grids. The sand-grid-filling process is shown in Figures 2-113 and 2-114.



Figure 2-113. Begin sand fill on left wall



Figure 2-114. Tamping sand into cells along center wall, viewed from pool side

To ensure minimum seepage under the levee, a mixture of Portland cement and sand was placed in the lowest grid cells (touching the floor). At the concrete wall abutments, a mixture of Portland cement and sand was packed into the grid cells touching the wall as shown in Figures 2-115 through 2-123. After the grid cells were filled with sand, they were tamped down and leveled off with a board (2×4). Total installation time was 5 hr - 28 min, or 32.8 man-hours. For a 62-ft linear footprint (measured along the leeward toe), the construction effort was 0.53 man-hours per linear foot.

Prior to filling the reservoir to begin the hydrostatic tests, laser targets were inserted into the grid cells and sealed with expandable foam (Figure 2-124). The lateral-displacement-monitoring cable was positioned over the center wall, and a blue paint stripe was sprayed onto the top of the center wall. The vendor representative verified in writing that the levee had been constructed properly and was ready for testing.

Prior to filling the reservoir to begin the hydrostatic tests, laser targets were inserted into the grid cells and sealed with expandable foam (Figure 2-124). The lateral-displacement-monitoring cable was positioned over the center wall, and a blue paint stripe was sprayed onto the top of the center wall. The vendor representative verified in writing that the levee had been constructed properly and was ready for testing.



Figure 2-115. Mixing cement and sand for placement in toe grid cells



Figure 2-116. Shoveling mixture into left wall toe grid cells



Figure 2-117. View of left concrete wall abutment from pool side



Figure 2-118. Completed sand and mixture fill, left concrete wall abutment



Figure 2-119. View of left wall/center wall buttress from pool side



Figure 2-120. Completed sand and mixture fill viewed from pool side



Figure 2-121. Mixture fill and tamping in center wall toe grid



Figure 2-122. Right wall buttress viewed from pool side



Figure 2-123. Right concrete wall abutment completed sand and mixture fill, viewed from pool side



Figure 2-124. Typical laser target installation

Performance

Barrier testing began after construction was completed. Three minor repairs were allowed within seven windows of opportunity during the tests, as described in Appendix C. After the overtopping test, one final repair (or rebuild) was allowed prior to the impact tests.

Disassembly and removal of the barrier was performed after testing was completed and the test basin was drained. An environmental evaluation was also performed for the barrier system, to include environmental hazards aspects of construction and disposal.

Hydrostatic head tests

The pool elevation was raised to three different elevations for a minimum of 22 hr at each predetermined elevation. During the testing period, levee movement and seepage values were recorded. During and after each test, the levee was inspected for weakness and/or failure before the pool elevation was raised to the next level.

Hydrostatic head test, 1-ft reservoir (33 percent height). The water level in the reservoir on the pool side of the levee was raised to a height of 1 ft (33 percent of levee height). Seepage flow rate was measured in the range from 0.017 to 0.025 gpm/ft (Figure 2-125), and no displacement was observed. Figure 2-126 shows the view from the pool side, including the lateral-displacement-monitoring system over the center wall. Figure 2-127 shows the view from the protected side, and Figure 2-128 is a view along the left wall.

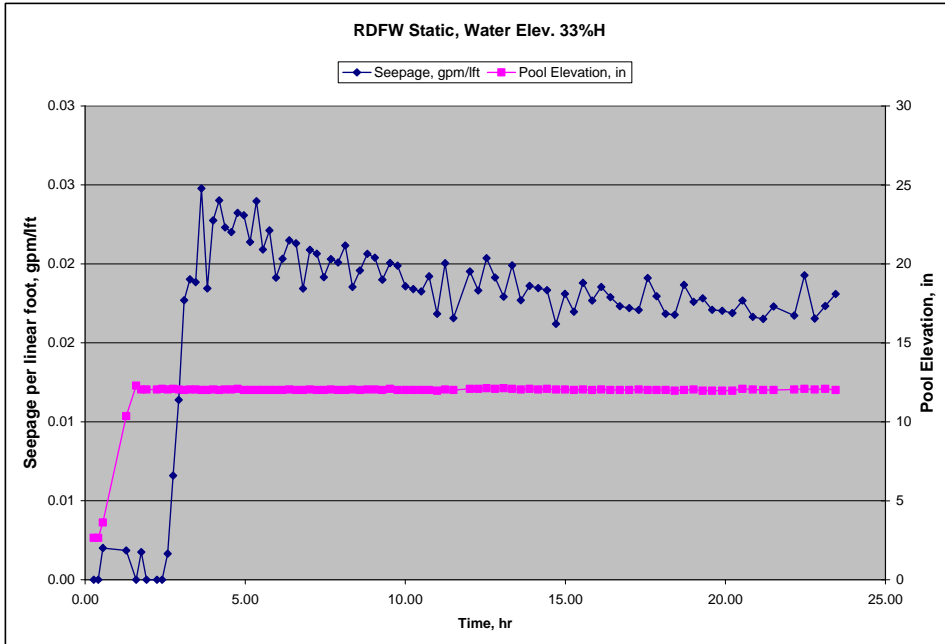

Figure 2-125. Seepage flow rate per linear foot at 1-ft pool elevation



Figure 2-126. View from pool side



Figure 2-127. View from protected side



Figure 2-128. View looking down at left wall

Hydrostatic head test, 2-ft reservoir (66 percent height). The water level in the reservoir on the pool side of the levee was raised to a height of 2 ft (66 percent of levee height). Seepage flow rate was measured in the range from 0.063 to 0.089 gpm/lft (Figure 2-129), and no horizontal displacement was observed. However, vertical settlement or subsidence can be seen in Figures 2-130 through 2-132. A white liquid can be seen in the seepage through the levee as shown in Figure 2-130.

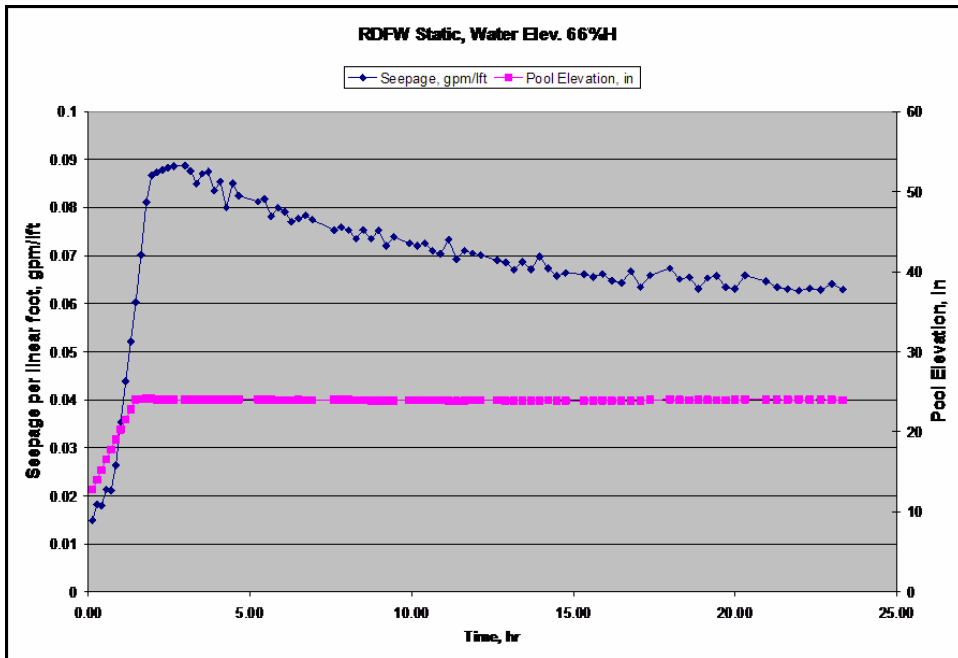

Figure 2-129. Seepage-flow rate per linear foot at 2-ft pool elevation (66% H)



Figure 2-130. View of seepage under left wall



Figure 2-131. Sand subsidence in outer grid cells along center wall



Figure 2-132. Left concrete wall abutment

Hydrostatic head test, 3-ft reservoir (95 percent height). The water level in the reservoir on the pool side of the levee was raised to a height of 34 in. (95 percent of levee height) as shown in Figure 2-133. Seepage flow rate was measured in the range from 0.084 to 0.108 gpm/ft (Figure 2-134), and no displacement was observed. Figure 2-135 shows that most of the leakage was observed coming from the wall corners. Figure 2-136 shows settlement along the right outside edge.



Figure 2-133. View from pool side

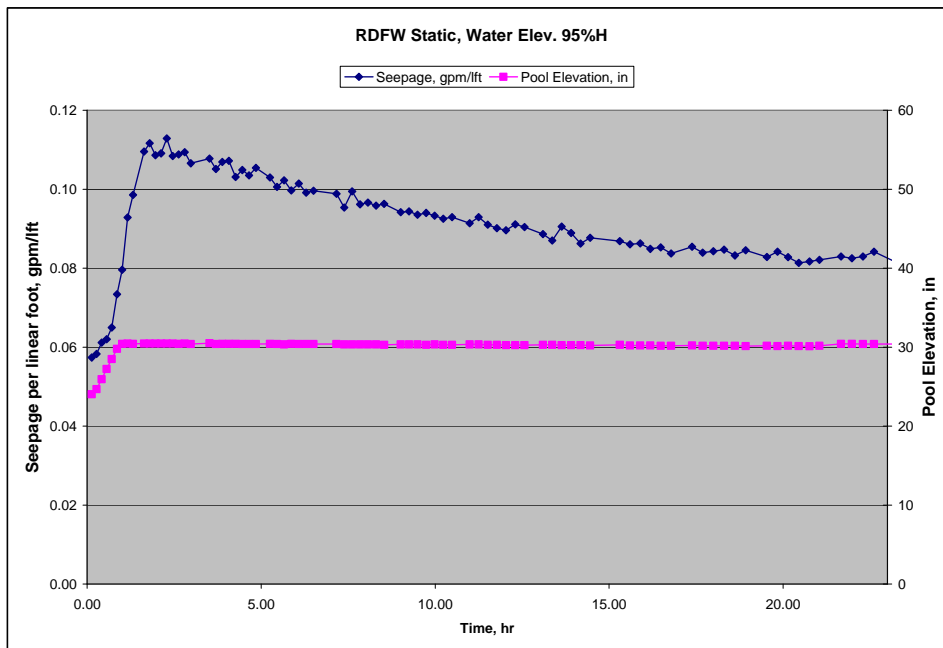

Figure 2-134. Seepage flow rate per linear foot at 95 percent pool elevation



Figure 2-135. View of seepage under structure



Figure 2-136. View looking down left wall

Hydrodynamic tests

The testing protocol specified that packets of monochromatic waves with a wave period $T = 2.0$ sec be generated to hydrodynamically impact the RDFW® levee. Hydrodynamic tests were performed at two different pool elevations (66 percent and 80 percent of levee height). At the 66 percent height, 3-in. waves (measured from trough to crest) were generated continuously for a period of 7 hr. Waves ranging from 7 to 9 in. were then allowed to impact the structure a total of 30 min (three 10-min intervals with 15 min calming periods between). Next, wave heights ranging from 10 to 13 in. were allowed to impact the structure for 10 min. The water was then raised to a level of 80 percent levee height and the preceding tests were repeated. At the end of each 10-min increment of wave testing (excluding the 7 hr of 3-in. waves), the testing basin was stilled for up to 45 min to allow the waves to dissipate.

3-in. wave test, reservoir level at 66 percent levee height. The water level in the reservoir on the pool side of the levee was lowered from the 95 percent level to a height of 24 in. within an interval of about 2 hr. The wave generator was activated and the waves began to impact the levee. The wave machines kept shutting off during this test, so that the wave machine ran for only 7 hr during this 20-hr period. Seepage flow rate was measured in the range from 0.034 to 0.042 gpm/ft (Figure 2-137), and no displacement was observed. No overtopping was observed.

Minimum subsidence of the sand in the grid units was noted at test conclusion. Figure 2-138 shows the left wall buttress and Figure 2-139 shows the right wall buttress, viewed from the lee side.

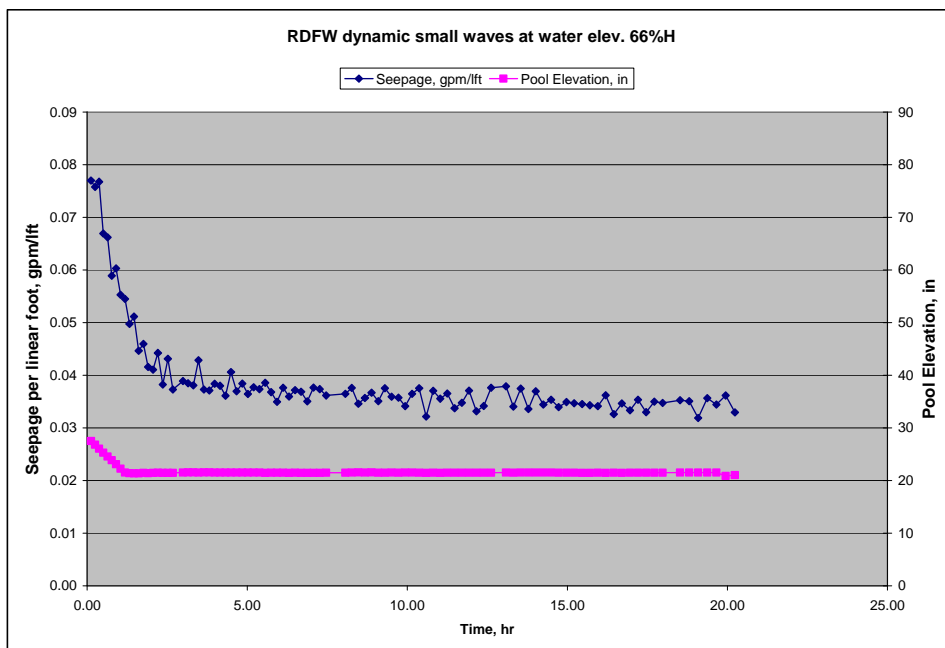

Figure 2-137. Seepage flow rate per linear foot, small wave at 66 percent pool elevation



Figure 2-138. Left wall buttress



Figure 2-139. Right wall buttress

7- to 9-in. wave test, reservoir level at 66 percent levee height. The water level in the reservoir on the pool side of the levee was held at a height of approximately 24 in., the wave generator was activated, and the waves began to impact the levee. Seepage flow rate was measured in the range from 0.025 to 0.042 gpm/ft (Figure 2-140), and no displacement or overtopping was observed. Figure 2-141 shows wave impact against the center wall near the right buttress.

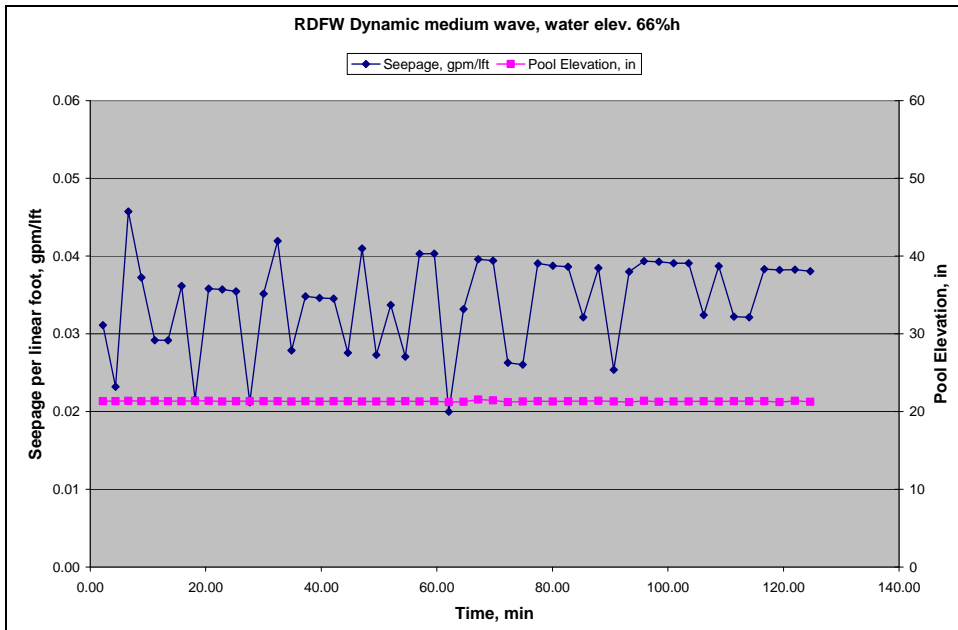

Figure 2-140. Seepage flow rate per linear foot, medium wave at 66 percent pool elevation



Figure 2-141. Wave impact against center wall

10- to 13-in. wave test, reservoir level at 66 percent levee height. The water level in the reservoir on the pool side of the levee was held at a height of approximately 24 in., the wave generator was activated, and the waves began to impact the levee. Seepage flow rate was measured in the range from 0.044 to 1.31 gpm/1ft (Figure 2-142) and no

displacement was observed. Overtopping did occur sporadically, which contributed to the flow rate increase. Figure 2-143 shows aftermath of wave action against the left wall near the concrete wall abutment. Minor surface erosion was evident.

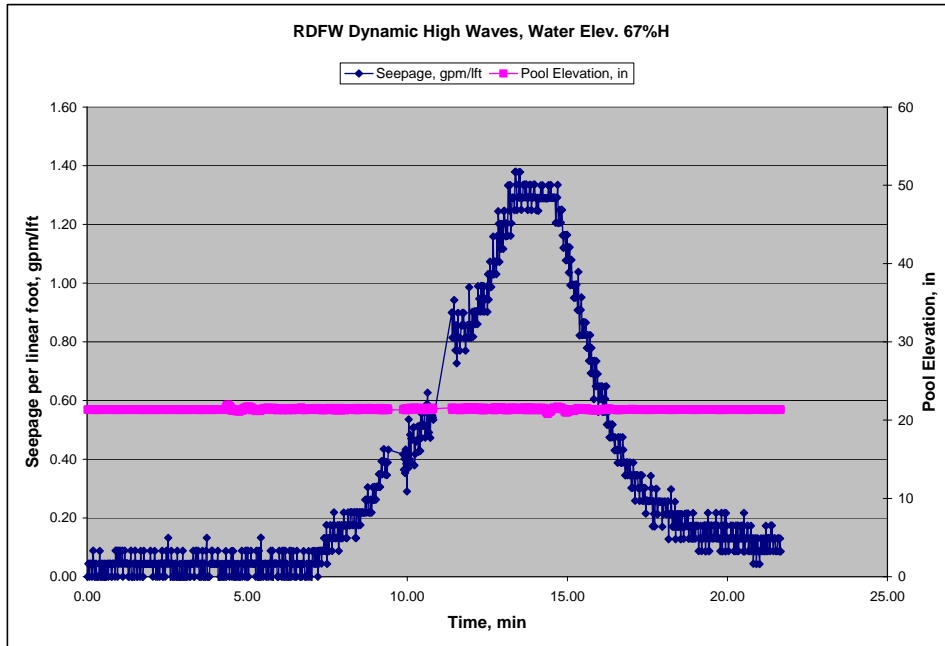

Figure 2-142. Seepage flow rate per linear foot, large wave at 66 percent pool elevation



Figure 2-143. Surface erosion from wave action

3-in. wave test, reservoir level at 80 percent levee height. The water level in the reservoir on the pool side of the levee was raised to a height of approximately 29 in., the wave generator was activated, and the waves began to impact the levee. Seepage flow rate was measured in the range from 0.039 to 0.046 gpm/ft (Figure 2-144), and no displacement was observed. No overtopping was observed, but some surface sand settling was observed (Figure 2-145).

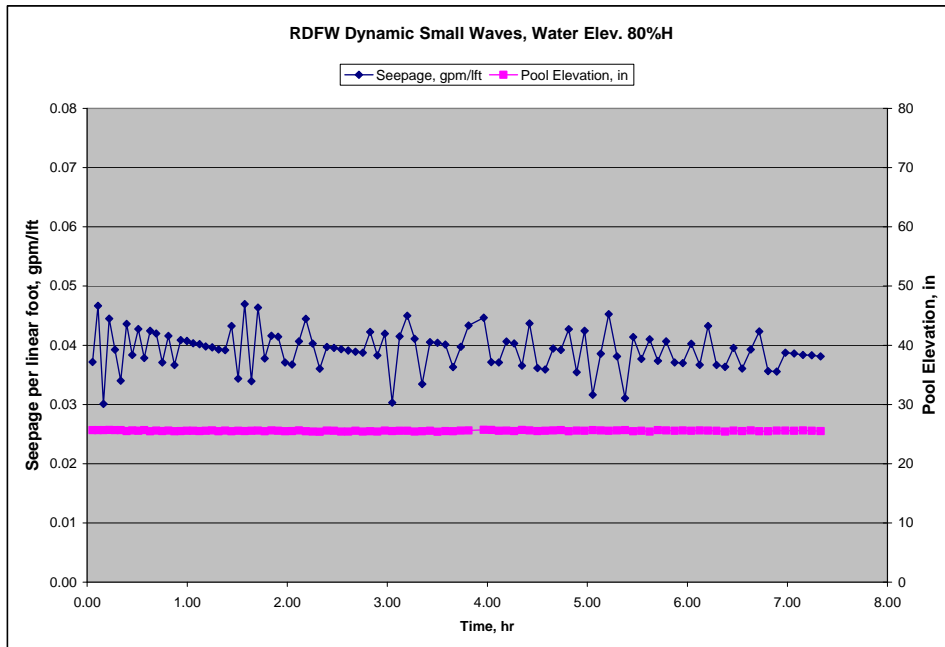

Figure 2-144. Seepage flow rate per linear foot, small wave at 80 percent pool elevation



Figure 2-145. View immediately after test showing some sand settling on left wall surface

7- to 9-in. wave test, reservoir level at 80 percent levee height. The water level in the reservoir on the pool side of the levee was held at a height of 29 in., the wave generator was activated, and the waves began to impact the levee. Seepage flow rate was measured in the range from 0.048 to 4.48 gpm/ft (Figure 2-146), and no displacement was observed. Overtopping did occur sporadically, which contributed to the flow rate increase (Figures 2-147 and 2-148).

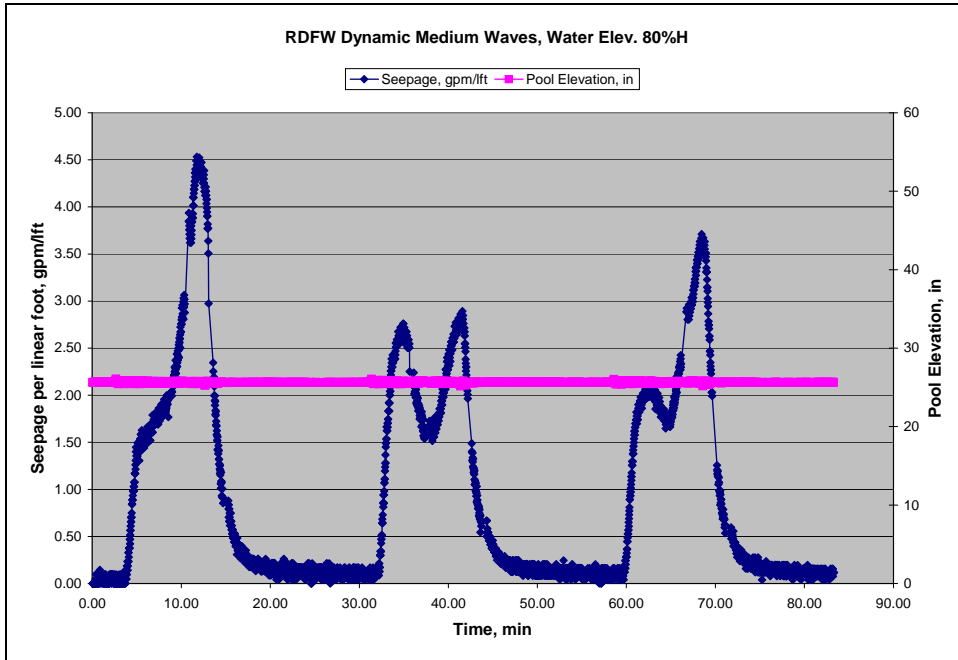

Figure 2-146. Seepage flow rate per linear foot with medium wave and 80 percent pool elevation



Figure 2-147. Sporadic wave overtopping at intersection of left and center walls



Figure 2-148. Sporadic wave overtopping at intersection of right and center walls

At the conclusion of the test, the condition of the levee structure was observed. As seen in Figures 2-149 and 2-150, minor surface erosion resulted from the sporadic wave overtopping action.



Figure 2-149. Surface erosion on left wall at conclusion of test



Figure 2-150. Close-up of surface erosion on left wall

10- to 13-in. wave test, reservoir level at 80 percent levee height. The water level in the reservoir on the pool side of the levee was held at a height of 29 in., the wave generator was activated, and the waves began to impact the levee. Seepage flow rate was measured in the range from 0.08 to 8.85 gpm/ft (Figure 2-151), and no displacement was observed. Overtopping occurred with each wave front (Figures 2-152 and 2-153).

Figures 2-154 and 2-155 are close-ups of the surface erosion observed at the test conclusion.



Figure 2-151. Waves overtopping left wall

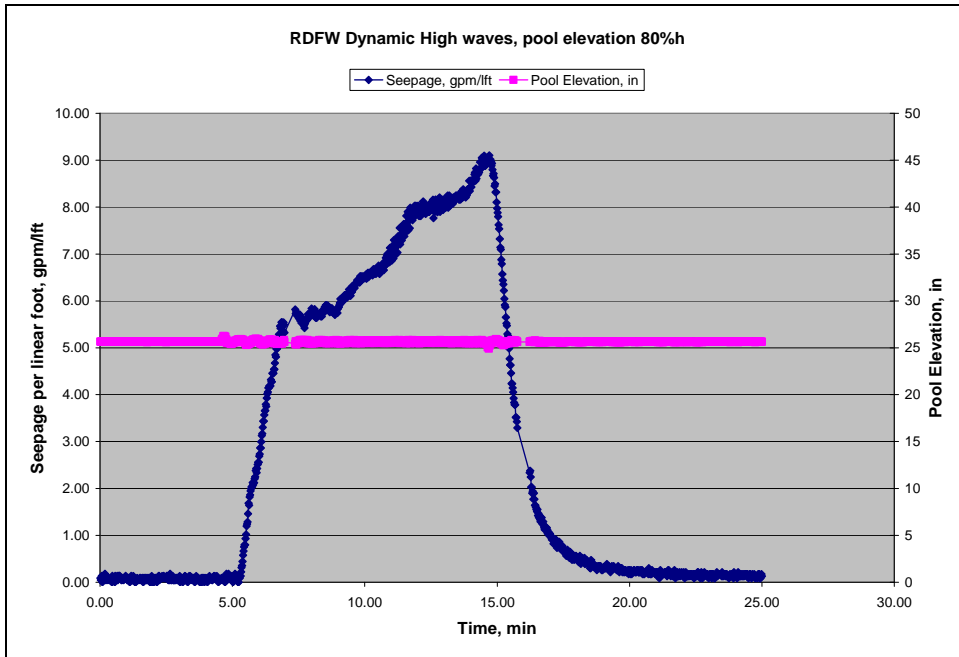

Figure 2-152. Seepage flow rate per linear foot, high wave at 80 percent pool elevation



Figure 2-153. Waves overtopping center wall



Figure 2-154. Close-up of center wall after test was concluded



Figure 2-155. Close-up at intersection of left and center walls

Levee overtopping test

The pool elevation was raised to 33.85 in., which was 1.85 in. higher than the levee. Overtopping was allowed for 1 hr, and measured flow rates ranged from 17.5 to 32.7 gpm/ft (285 to 2400 gpm), see Figure 2-156. The overtopping flow was uniform due to the uniform levee height.

Figure 2-157 shows an overall view of the overtopped levee. Figure 2-158 shows a close-up of the left wall with the overtopping test in progress, and Figure 2-159 shows the eroded sand on the concrete floor after the test was concluded.

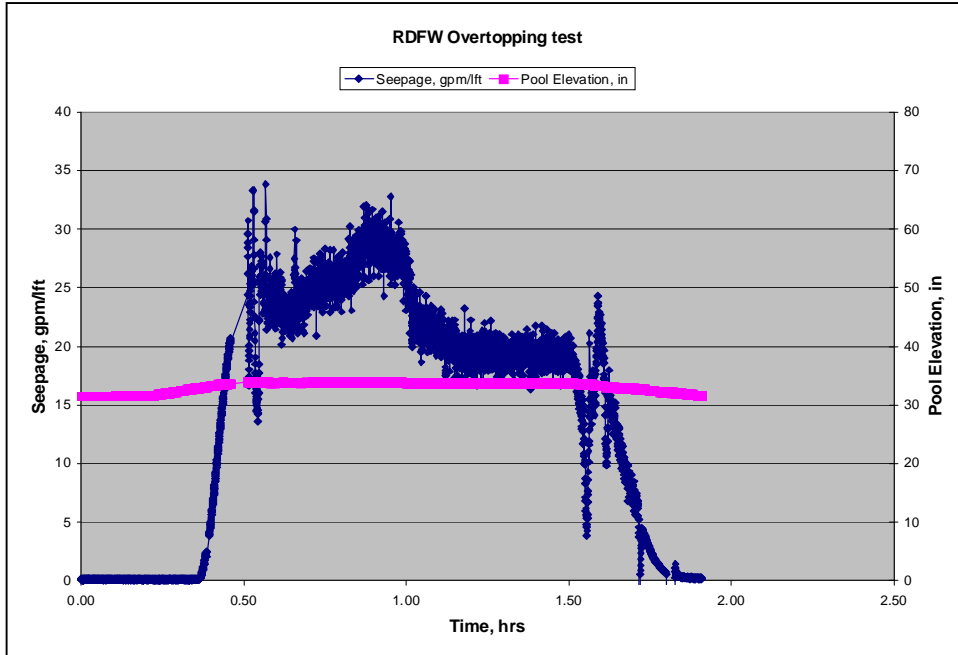

Figure 2-156. Seepage flow rate per linear foot during overtopping



Figure 2-157. Overtopped levee



Figure 2-158. View along left wall

Debris impact test

With reservoir level at 24 in., the log impact tests were begun. Figure 2-159 shows the impact test setup prior to the test.

The 12-in. log impacted the structure and bounced back without any noticeable damage to the structure. The structure responded to the impact but did not permanently displace. The 16-in. log (Figure 2-160) impacted the structure and also bounced back (Figure 2-161) without causing any noticeable damage or permanent displacement.

Maintenance and repair

Repair 1 was performed before the 95 percent hydrostatic test. A four-man crew took 29 min (1.93 man-hours) to add sand on top of the levee, using shovels, buckets, and the Bobcat® loader. Repair 2 was performed prior to the 80 percent small (3 in.) wave test. A two-man crew took 21 min (0.68 man-hours) to fill sand in various voids along the levee crest, and add reinforcing plastic strips, again using shovels, buckets, and the Bobcat® loader. Repair 3 was performed prior to overtopping. A four-man crew took 29 min (1.95 man-hours) to fill sand voids along the levee crest using the same equipment plus a portable vacuum cleaner.

Disassembly and reusability

Disassembly and removal took a six-man crew 7 hr (13.4 man-hours) using the Bobcat® loader, the Hyster® forklift, two portable vacuum cleaners, five shovels, and brooms. Eroded sand outside the toe grids was first removed (Figure 2-162). The toe

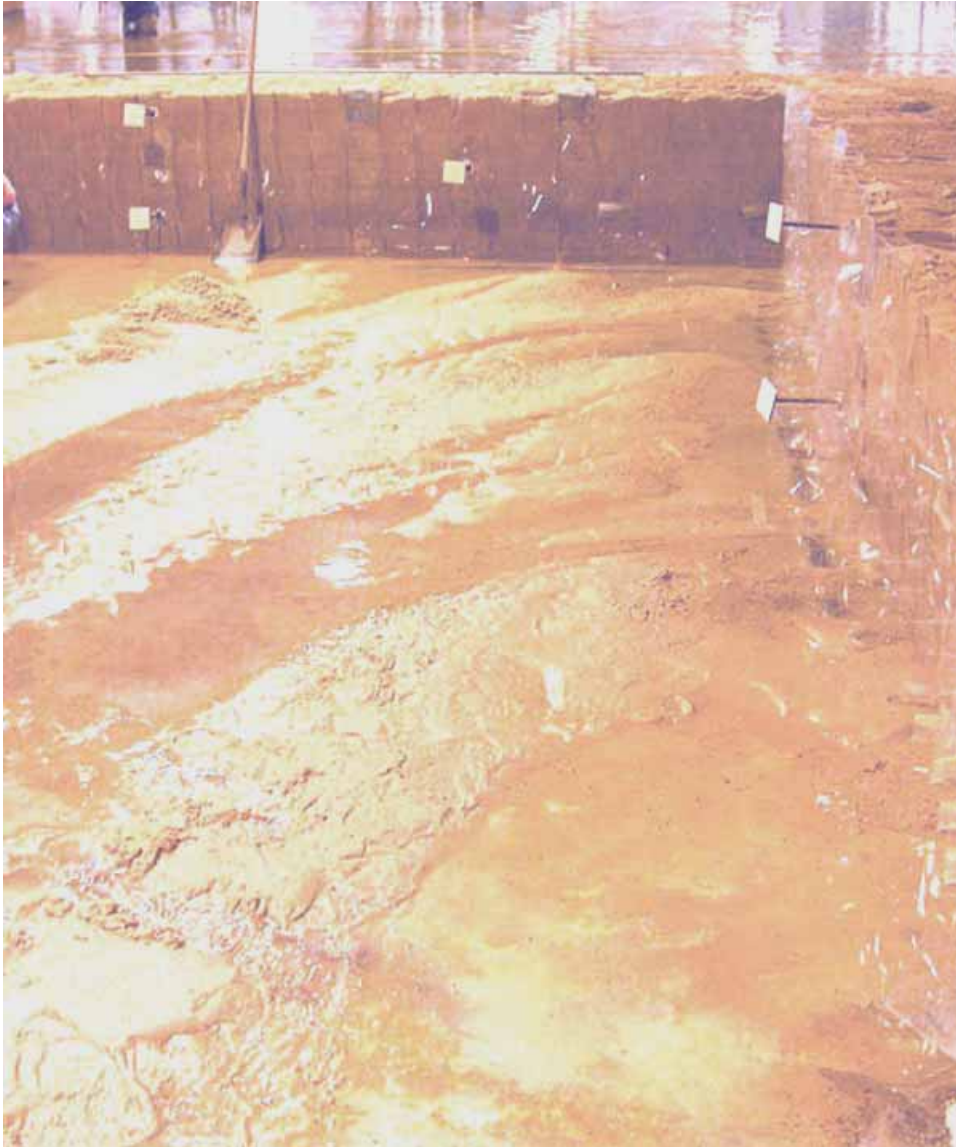

Figure 2-159. Eroded sand deposited on floor (view toward center and right walls)

grids were then removed after the enclosed sand was removed using a vacuum cleaner and shovels, and Bobcat® loader (Figures 2-163, 2-164, 2-165 and 2-166). The upper layer of sand was then removed from the top grid units on each wall, using a vacuum cleaner and shovels (Figures 2-167, 2-168, and 2-169).



Figure 2-160. Impact test setup



Figure 2-161a. Log impact



Figure 2-161b. Bounce-back



Figure 2-162. Scooping up eroded sand along toe grid units



Figure 2-163. Vacuuming sand out of toe grid units



Figure 2-164. Shoveling out sand/cement mixture from toe grid units and pulling out grid



Figure 2-165. Removing toe grid materials



Figure 2-166. Cleaning out remaining toe grid materials



Figure 2-167. Removing sand from top of wall



Figure 2-168. Removing sand using vacuum cleaner



Figure 2-169. Removing sand using shovels

Figures 2-170 through 2-177 show the general sequence for removing the grid units. After enough sand has been removed, the unit is manually loosened from the frictional resistance of the remaining sand. After detaching the grid unit tabs, the reusability of each grid unit was assessed. If reusable, the unit was cleaned of sand, folded flat, and stacked back in the storage container.



Figure 2-170. Removed sand from outer grid cells



Figure 2-171. Loosening grid unit to reduce frictional resistance from sand



Figure 2-172. Pulling grid unit in an upward fashion



Figure 2-173. Loosened grid unit



Figure 2-174. Loosening attached grid units



Figure 2-175. Removing grid units from wall



Figure 2-176. Disassembling grid unit for future reuse



Figure 2-177. Reusable grid units ready for cleaning, refolding, and stacking

The preceding sequence was repeated for each grid unit layer until the entire levee structure was disassembled. Figures 2-178 through 2-182 are views of the remainder of levee removal. Assistance from the small front-end loader achieved greater removal speed, but decreased the reusability of the grid units due to damage. Figure 2-184 shows a debris pile of nonreusable grid units mixed with sand and sand/cement materials.

Due primarily to the effects of disassembly, approximately 10 percent of the plastic material was nonreusable and nonrepairable. According to the manufacturer's literature, normally-anticipated breakage is repaired by replacing the broken grid unit piece or by reinforcing the broken piece. Manufacturer stipulations apply regarding reusability and placement of repaired grid units back into service.

Environmental aspect

All materials used were nonhazardous and nontoxic. Technical information and Material Safety Data Sheets (MSDS) for the plastic grid units provided by RDFW® indicated no exposure hazards due to everyday usage of the construction materials. The sand fill also presented no exposure hazard.



Figure 2-178. Continuation of sand removal using shovels



Figure 2-179. Preparing to remove one of second layer grid units. Note bandaged wrists to prevent cuts and scrapes from grid units



Figure 2-180. Removing a grid unit



Figure 2-181. Bottom layer removal assistance provided by small loader



Figure 2-182. Removing grid unit/sand combination



Figure 2-183. Some nonreusable grid units



Figure 2-184. Nonreusable grid units, sand, and sand/cement mixture ready for disposal

From an overall environmental consideration, the RDFW does not pose a substantial threat to the environment after the wall is constructed and filled with sand. The co-polyester that makes up the framework for the wall is not affected by water coming into contact with it during a flood. There are no health effects with the material in the solid state that the material is used for during the construction. It should be noted that a cement mixture was placed on the front side of the structure during construction. During testing of the structure, water was collected from the seepage through the barrier and measured for pH. The pH of the water was 11.61. This is a high pH for the water, since a pH of 7 is considered neutral. During a flood event, this high pH will probably be diluted due to the large volume of water.

Upon completion of use of the RDFW, the structure should be removed from the site. The co-polyester material that forms the cells for the barrier is reusable and should be disassembled and packed up for removal. The co-polyester material should not be left onsite due to the small cells formed in the structure, which could trap small animals. If the co-polyester structure cannot be reused, then it should be disposed of by recycling or land-filling. This material should not be burned due to the formation of carbon dioxide and carbon monoxide upon combustion.

Should the floodwater be contaminated with waterborne bacteria or pollutants, the sand fill inside the units also may become contaminated. The plastic grid itself should provide some physical barrier protection for nonwater-soluble contaminants such as floating oil, but water-soluble or suspended contaminants would likely be adsorbed by the sand fill. The sand used to fill the structure should be disposed of in an appropriate manner. If the floodwater is contaminated then the sand will have to be tested for the contaminants of concern. If it turns out the sand is contaminated then it will have to be disposed of according to the appropriate regulations. The cement mixture placed in the

front of the structure will have to be removed also. A pH test of the soil around the structure will need to be performed to determine if the soil has a high pH. If the soil has an elevated pH then the pH might have to be adjusted so that vegetation can grow on the surface.

Since the sand used to fill the RDFW is placed into the barrier by machinery, the work site will have to be cleaned and put back into original condition. The main problem to be concerned with is that the machinery could create depressions and ruts in the ground that could be conducive to erosion. Problem places around the structure and work area should be repaired before the site is vacated.

Portadam® Levee Tests

Design

The Portadam® company (<http://www.portadam.com>) specializes in water-diversion and cofferdam structures (Portadam® 2004). The Portadam® system is a steel framework supporting a vinyl liner, which acts as a dam to prevent floodwater damage inside the area protected by the structure. No fill materials are required, but sandbags are typically used to weight down the liner's bottom edge (the apron). The top edge of the liner is tied to the steel frame.

The steel framework and vinyl liner are manufactured in various lengths and sizes depending on the application. The system provided for this test consisted of a frame 5 ft high with 5-ft base width, and a vinyl coated polyester tarp (18 oz/sq yd Style 3818 manufactured by Seaman, Inc). The tarp extends from lying flat on the floor in front of the frame up to and attached to the front face of the frame at a height of 3 ft for this test.

Engineering analysis of the structural capacity to resist overturning, sliding, bending moments, and failure by bursting were provided by PortaDam®. The system concept utilizes the hydraulic pressure applied by the water load on the outside to produce an apron seal. The slope angle for the 5-ft frame is 42 deg, which allows a safety factor against sliding greater than 1 at a 5-ft flood crest. Maximum bending moment on the steel frame is 2,147 ft-lb, but frame section properties and safety factor were not presented. Vinyl tarp tensile failure stress was listed at 132 N, and ultimate tensile strength is 3,855 N, implying a safety factor of 29 against fabric bursting. Although no anchoring is required at a grassed field site, on the concrete floor a heel stop was recommended for the frame base to increase friction resistance against sliding.

For the ERDC test, the 5-ft steel frames, a roll of vinyl tarp, and a barrel of connectors were furnished. Commercial price to purchase the materials was listed as approximately \$62 per linear foot.

Construction

Layout of the Portadam® levee frame is shown in Figure 2-185. The 2-in. × 6-in. treated lumber heel stop was installed by ERDC personnel prior to constructing the levee by bolting into the concrete floor at 4-ft intervals.

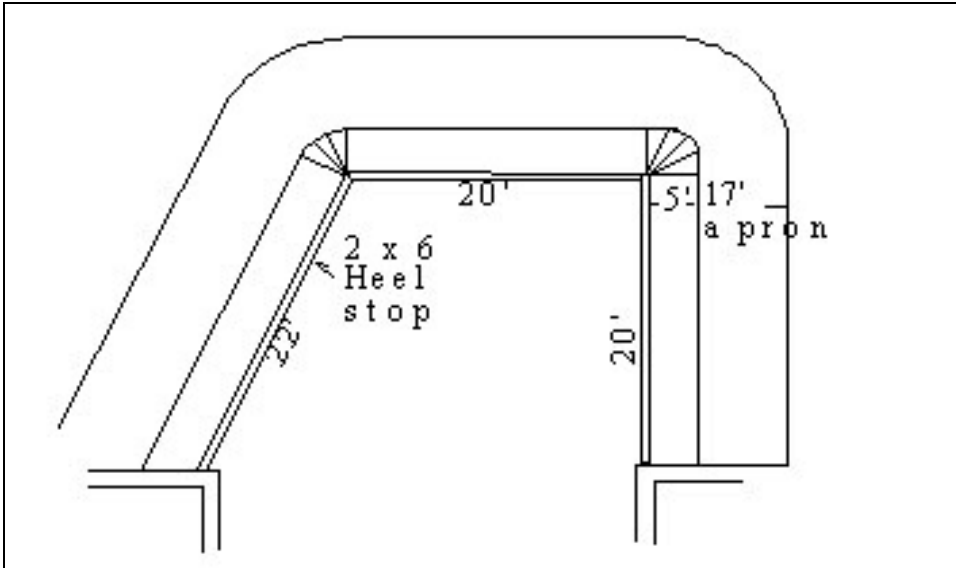

Figure 2-185. Portadam® levee layout

Ambient air temperatures inside the enclosed metal hangar quickly rose from the mid-70s up to the mid-90s by late morning. Fans were placed in the work area, and water and electrolytic fluids were made available to all workers and observers.



Figure 2-186. Air temperature monitor

The steel frames were bundle-shipped, loaded into the back of a pickup truck, and delivered to the test facility along with connecting bolts and the vinyl tarp. A Portadam® supervisor, four laborers unfamiliar with the product, and a forklift operator began the installation sequence. After a 2-min introduction and training session, three of the laborers began filling sandbags to weigh down the apron (Figures 2-187 and 2-188). The forklift operator unloaded and delivered the frames into the test facility. One laborer and the supervisor began assembling and installing the steel frames outward from the heel stop. Each frame weighed 28 lb.



Figure 2-187. Apron sandbag filling operation



Figure 2-188. Transporting sandbags

The frames were assembled in pairs with two hand-tightened bolts connecting the lower legs (Figure 2-189). The assembled pair weighed 56 lb and was moved into position against the heel stop (Figures 2-190, 2-191, and 2-192). A top spreader bar



Figure 2-189. Connection at lower leg of frames



Figure 2-190. Frame 2 x 6 heel stop



Figure 2-191. Beginning frame installation from right abutment wall



Figure 2-192. Frame installation against heel stop from left abutment wall

(4 lb) was installed at the top of the frame pair, which produced a “V” shaped frame pair spanning a linear distance of 28 in. The next frame “V” pair was set next to and in line with the previous frame pair and was connected at the top with an adjustable channel iron clamp (9 lb). The clamp has one bolt, which is preassembled into the clamp and is tightened with a ratchet and socket (Figure 2-193). The “V” frames were installed in sequence along the straight sections of levee, and were positioned in the 90- and 60-deg angled corners by adjusting the frames and clamp locations (Figures 2-194 and 2-195). Figure 2-196 shows the completed frame assembly.

After the frame installation was completed by the laborer and supervisor (in 85 min), concurrently with sandbag filling (three laborers took 75 min to fill 100 sandbags) and delivery via forklift, the vinyl tarp was ready to be installed.

After a weeklong delay in shipping the selected vinyl tarp, installation resumed. The same labor crew was onsite.

The Hyster® forklift (see Figure 2-188 above) offloaded the tarp from a pickup truck bed as two laborers resumed the sandbag filling operation (Figure 2-197). Two laborers and the supervisor then unrolled the tarp (Figure 2-198) and began placing a sandbag on the floor between each “V” frame opening (total of 51 sandbags) (Figure 2-199). The sandbags were placed for the purpose of buttressing the lee side of the vinyl tarp against water pressure bulges.



Figure 2-193. Frame bracket



Figure 2-194. Installing frame at 90-deg corner



Figure 2-195. Frames at 60-deg corner, front view



Figure 2-196. Completed frame assembly



Figure 2-197. Offloaded vinyl tarp sections to begin unrolling operation



Figure 2-198. Unrolling tarp section



Figure 2-199. View of sandbags placed between each frame opening

Next they secured the two separate tarp pieces together by inserting hairpin cotter pins (Figure 2-200) spaced approximately 4 in. apart along the seam (Figure 2-201), rolling two seam flaps together (Figure 2-202) and fastening the overlap with hook and loop pile strips along the seam length (Figures 2-203 and 2-204).



Figure 2-200. Hairpin cotter for securing two vinyl tarp sections together



Figure 2-201. Securing two tarp sections together with hairpin cotters



Figure 2-202. Rolling seam



Figure 2-203. Hook and loop fastening seam flap



Figure 2-204. Vinyl tarp seam connection complete

The tarp was then pulled upward onto the frame and nylon cords were tied to secure the tarp on the frame (Figures 2-205 and 2-206). The apron was pulled outward and its edge was taped to the concrete floor with 4-in. wide adhesive roll tape. A single row of sandbags was then laid over the taped edge (Figure 2-207).



Figure 2-205. Pulling vinyl tarp up to frame



Figure 2-206. Tying tarp to frame



Figure 2-207. Taping apron to concrete floor and placing sandbags over tape

At the end of the joined vinyl tarp sections, expandable foam was used to seal against any possible water leakage. The apron edge sandbag was then placed back into position (Figure 2-208).



Figure 2-208. Expandable foam treatment at vinyl tarp apron edge

At each concrete wingwall abutment, a can of expandable foam was sprayed on the concrete wall/floor junction and the tarp was pushed against the wall. A vertical 2×4 was placed to hold the tarp against the wall, and sandbags were placed against the wall (Figures 2-209 and 2-210). The total number of sandbags placed inside the steel frames, over the apron edge, and at wall abutments was 178.



Figure 2-209. Expandable foam treatment at concrete wall abutment



Figure 2-210. Sandbags and 2x4 board along concrete wall abutment

After each abutment/tarp interface was treated, rope-tying the tarp to the frame was finalized, and the barrier construction was essentially complete (Figure 2-211). Prior to filling the reservoir to begin the hydrostatic tests, laser targets were positioned on the steel frames (Figures 2-212 and 2-213). A pool elevation sensor was then positioned on top of the center apron (Figure 2-214).



Figure 2-211. Portadam® levee construction completed

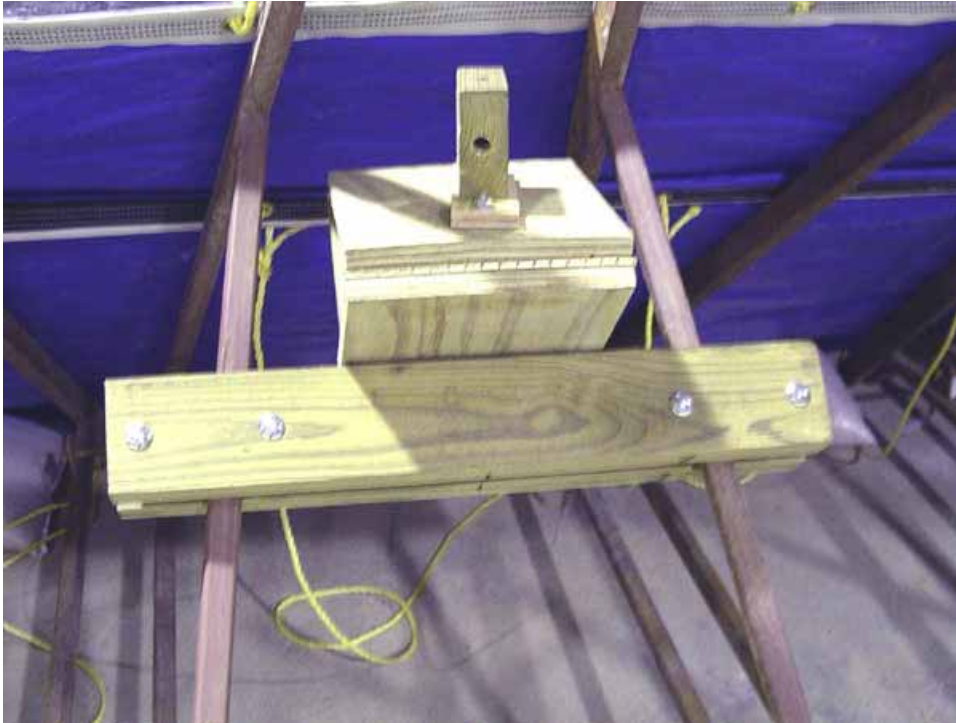

Figure 2-212. Laser target mount

Total duration to install the Portadam® barrier was 4.07 hr with a crew of six men. On a man-hour basis, the installation took 24.4 man-hours. The vendor representative verified in writing that the levee had been constructed properly and was ready for testing.



Figure 2-213. Installing one of laser targets



Figure 2-214. Pool elevation sensor placed on center apron

Performance

Barrier testing began after construction was completed, and performance of the barrier was documented. Three minor repairs were allowed within seven windows of opportunity during the tests, as described in Appendix C. After the overtopping test, one final repair (or rebuild) was allowed prior to the impact tests.

Disassembly and removal of the barrier was performed after testing was completed and the test basin was drained. An environmental evaluation was also performed for the barrier system, to include environmental hazards aspects of construction and disposal.

Hydrostatic head tests

The pool elevation was raised to three different elevations for a minimum of 22 hr at each predetermined elevation. During the testing period, levee movement and seepage values were recorded. During and after each test, the levee was inspected for weakness and/or failure before the pool elevation was raised to the next level.

Hydrostatic head test, 1-ft reservoir (33 percent height). The water level in the reservoir on the pool side of the levee was raised to a height of 1 ft (33 percent of levee height). As the initial pool elevation began to rise, some air pockets under the apron were observed. The supervisor walked out and placed a few sandbags on these air pockets to flatten them out (Figure 2-215). The barrier had very little water seepage, ranging from

0.08 to 0.11 gpm/lft (Figures 2-216 and 2-217). Zero displacement was observed. Prior to the next test, Repair 1 was performed (discussed in the following paragraphs).

Hydrostatic head test, 2-ft reservoir (66 percent height). The water level in the reservoir on the pool side of the levee was raised to a height of 2 ft (66 percent of levee height). Seepage rate was similar to the 1-ft head test, ranging from 0.12 to 0.15 gpm/lft (Figure 2-218), and no displacement was observed. Figure 2-219 shows a typical view.



Figure 2-215. Air bubbles beneath apron

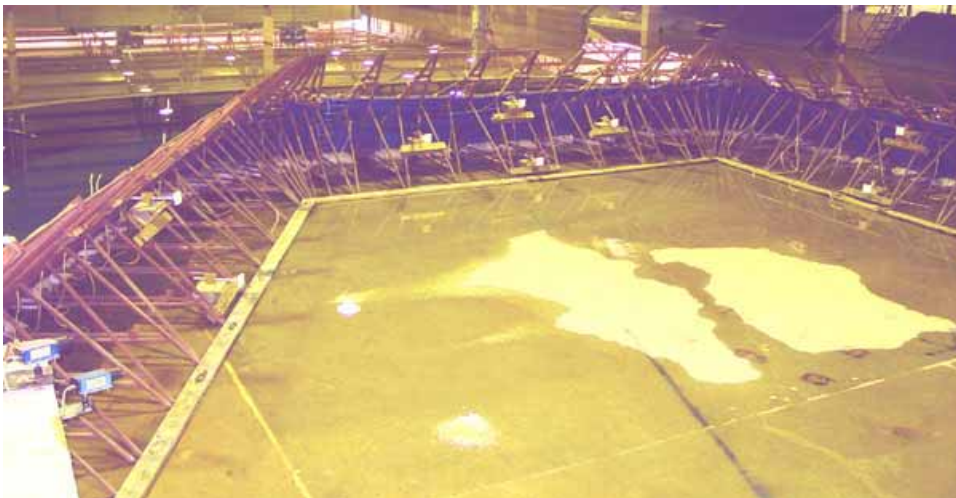

Figure 2-216. Under-apron seepage at 1-ft hydrostatic test

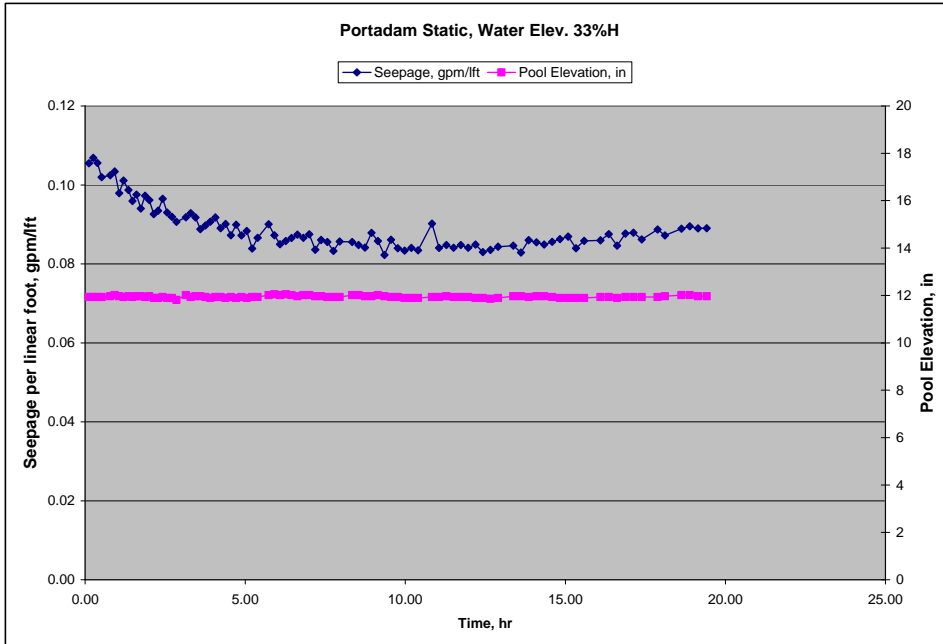

Figure 2-217. Seepage flow rate per linear foot at 1-ft pool elevation (33% H)

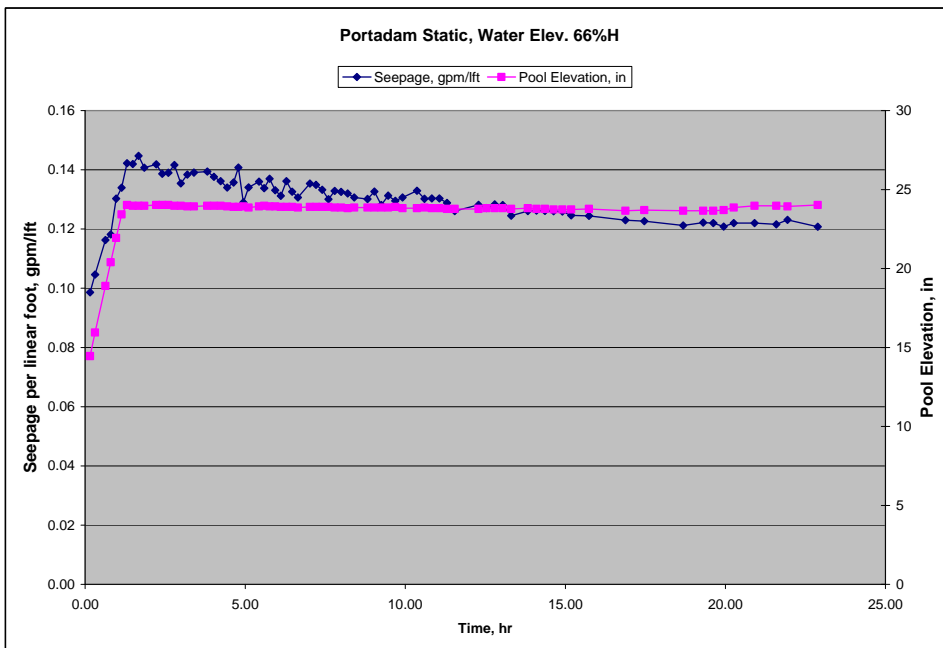

Figure 2-218. Seepage flow rate per linear foot at 2-ft pool elevation (66% H)



Figure 2-219. View of right wing from pool side, 2-ft hydrostatic head

Hydrostatic head test, 3-ft reservoir (95 percent height). The water level in the reservoir on the pool side of the levee was raised to a height of 34 in. (95 percent of levee height). Seepage ranged from 0.13 to 0.15 gpm/ft (Figure 2-220), and zero displacement was observed. Figure 2-221 shows a typical view.

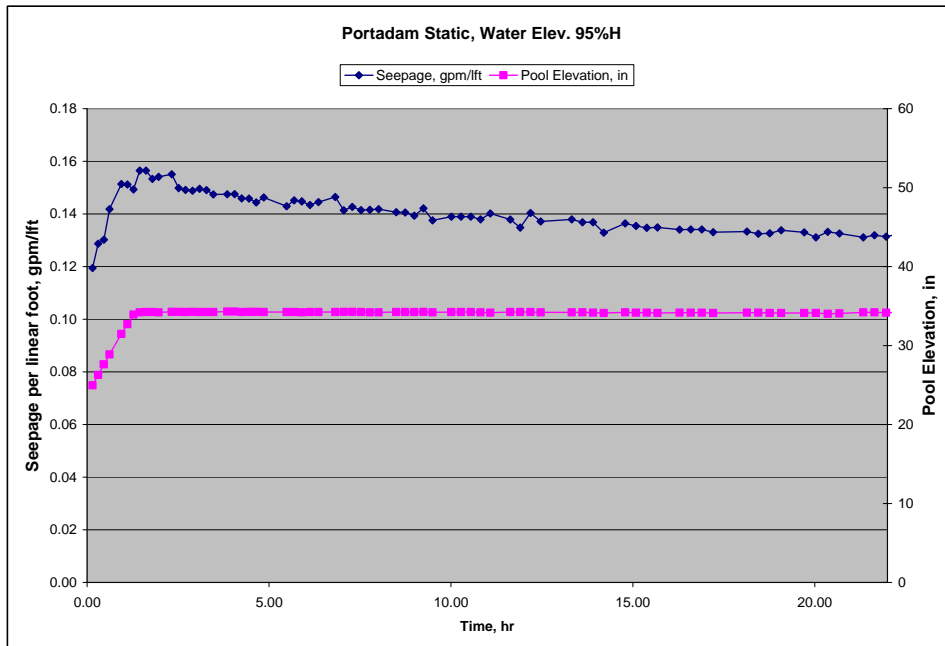

Figure 2-220. Seepage flow rate per linear foot at 95 percent pool elevation



Figure 2-221. View of right wing from pool side at 95 percent (3-ft) pool elevation

Hydrodynamic tests

The testing protocol specified that packets of monochromatic waves with a wave period $T = 2.0$ sec be generated to hydrodynamically impact the Portadam® levee. Hydrodynamic tests were performed at two different pool elevations (66 percent and 80 percent of levee height). At the 66 percent height, 3-in. waves (measured from trough to crest) were generated continuously for a period of 7 hr. Waves ranging from 7 to 9 in. were then allowed to impact the structure a total of 30 min (three 10-min intervals with 15-min calming periods between). Next, wave heights ranging from 10 to 13 in. were allowed to impact the structure for 10 min.

The water was then raised to a level of 80 percent levee height and the preceding tests were repeated. The order of testing was changed by postponing the 3-in. wave test until after the 7- to 9-in. and 10- to 13-in. tests were conducted, due to a scheduling change requested by the onsite Portadam® representative. At the end of each 10-min increment of wave testing (excluding the 7 hr of 3-in. waves), the testing basin was stilled for up to 15 min to allow the waves to dissipate.

3-in. wave test, reservoir level at 66 percent levee height. The water level in the reservoir on the pool side of the levee was lowered from the 95 percent level to a height of 24 in. within an interval of about 2 hr. The wave generator was activated, and the waves began to impact the levee. Flow rate ranged from 0.08 to 0.09 gpm/ft (Figure 2-222), and appeared to be uniformly seeping under the vinyl. No displacement and no overtopping waves were noted. Figure 2-223 shows a typical view from the pool side.

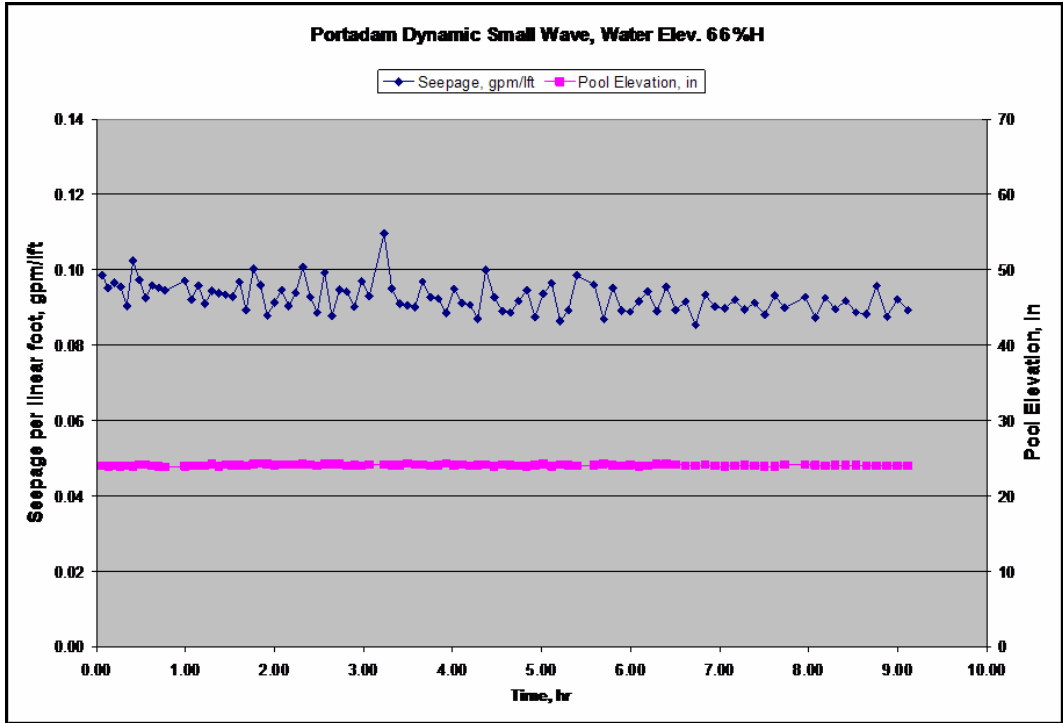

Figure 2-222. Seepage flow rate per linear foot with small waves at 66 percent pool elevation



Figure 2-223. View of right wall, small waves at 66 percent height

7- to 9-in. wave test, reservoir level at 66 percent levee height. The water level in the reservoir on the pool side of the levee was held at a height of 24 in., the wave generator was activated, and the waves began to impact the levee. Flow rate remained steady, ranging from 0.08 to 0.10 gpm/ft (Figure 2-224), and appeared to be uniformly

seeping under the vinyl. No displacement and no overtopping waves were noted. Figure 2-225 shows wave action as viewed from the right wall.

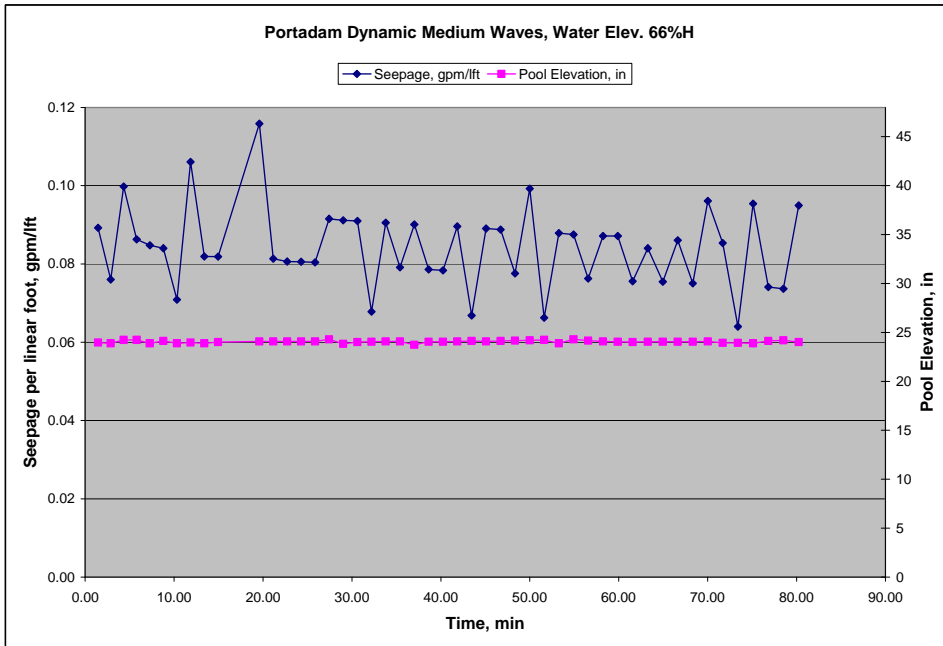

Figure 2-224. Seepage-flow rate per linear foot with medium waves at 66 percent pool elevation



Figure 2-225. Wave action from medium waves at 66 percent height

10- to 13-in. wave test, reservoir level at 66 percent levee height. The water level in the reservoir on the pool side of the levee was held at a height of 24 in., the wave generator was activated, and the waves began to impact the levee. Flow rate ranged from 0.08 to 0.36 gpm/1ft (Figure 2-226). No displacement was noted, but wave overtopping occurred with each wavefront and contributed to the increased flow rate. Figures 2-227 and 2-228 show the high wave action. The test was running from 14 to 24 min on the

timeline. It should be noted that the seepage rate lags the start of wave action during the test and continues to rise and then fall after the test is complete.

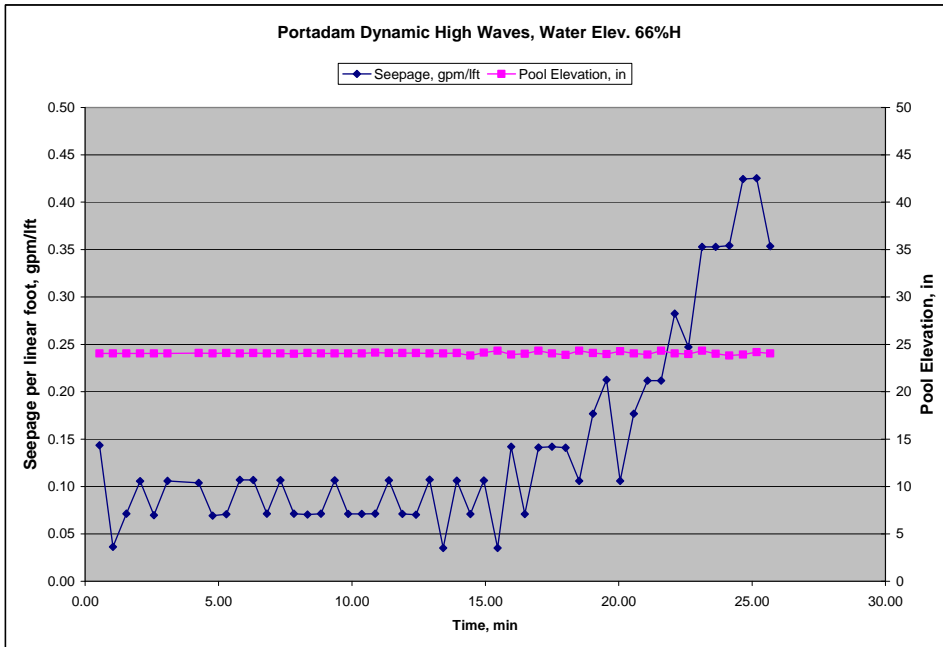

Figure 2-226. Seepage flow rate per linear foot with high wave at 66 percent pool elevation



Figure 2-227. Wave action from high waves at 66 percent height

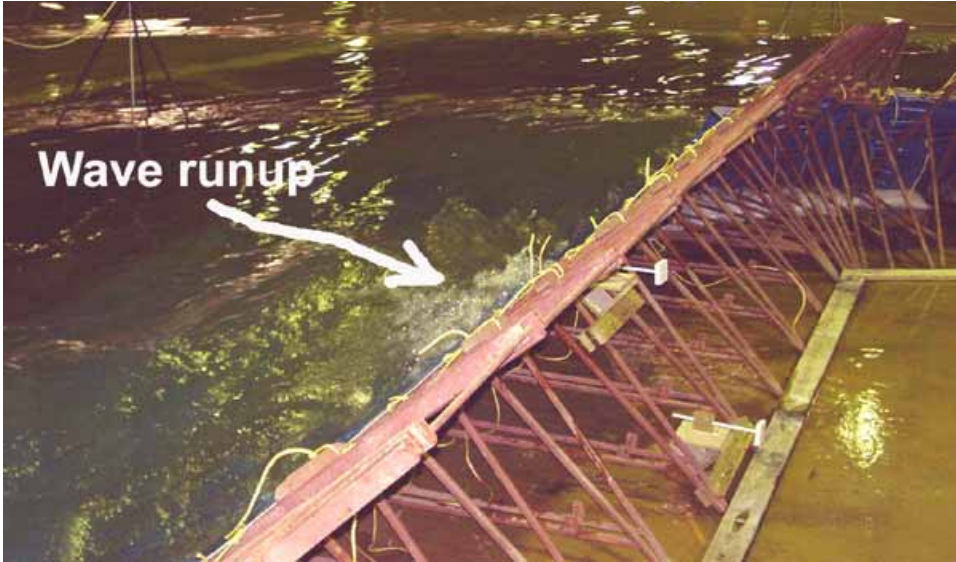

Figure 2-228. Wave action from high waves at 66 percent height, view inside left wall

3-in. wave test, reservoir level at 80 percent levee height. This test was performed out of order from the protocol and just prior to the overtopping test. The water level in the reservoir on the poolside of the levee was held at a height of 29 in., the wave generator was activated, and the waves began to impact the levee. No wave run-up and overtopping actions were observed, and the total flow rate ranged from 0.09 to 0.1 gpm/ft (Figure 2-229). No wave overtopping and no displacement were noted. The 80 percent height was held overnight after conclusion of the 3-in. test to facilitate the overtopping test.

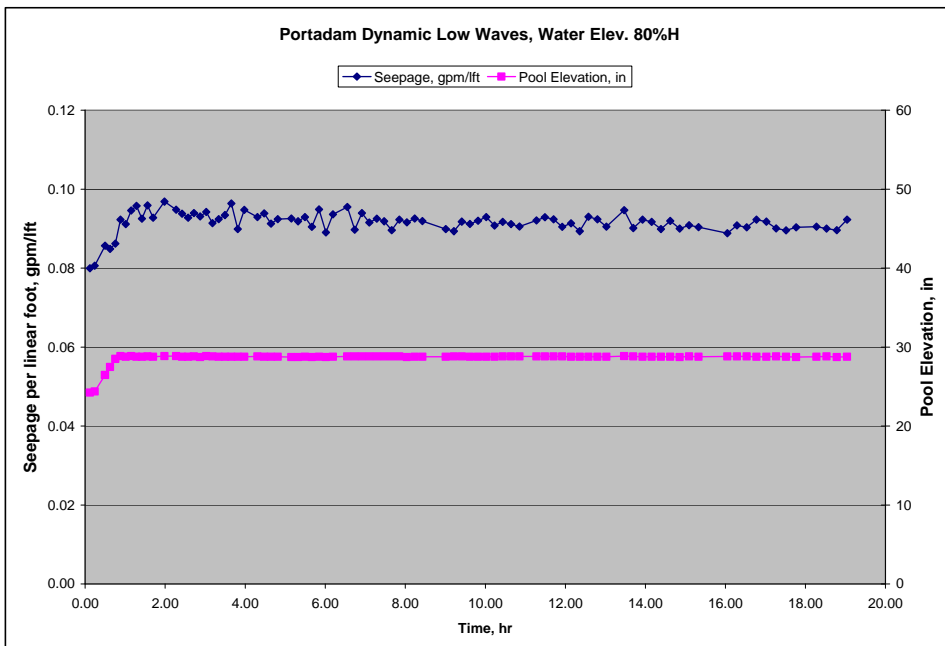

Figure 2-229. Seepage flow rate per linear foot, low waves at 80 percent pool elevation

7- to 9-in. wave test, reservoir level at 80 percent levee height. The water level in the reservoir on the pool side of the levee was raised to a height of 29 in., the wave generator was activated, and the waves began to impact the levee. As previously noted, the 2- to 3-in. wave test was not conducted prior to the 7- to 9-in. test. Another deviation was that the first wave test at the 80 percent height was aborted due to inaccurate water level input for the wave generator. Actual initial wave heights were approximately 10 in. (shown in Figure 2-230), and the test was stopped prior to conducting the 7- to 9-in. wave test.



Figure 2-230. Aborted wave test showing wave overtopping along left wall

The 7- to 9-in. test were conducted within a few minutes after the wave basin was stilled from the aborted test. Wave run-up and overtopping contributed to raising the seepage pit flow rate from the rate of 0.175 to 10.72 gpm/ft (Figure 2-231). No displacement was noted. Figure 2-232 shows typical wave overtopping.

10- to 13-in. wave test, reservoir level at 80 percent levee height. The water level in the reservoir on the pool side of the levee was held at a height of 29 in., the wave generator was activated, and the waves began to impact the levee. Flow rate increased from 0.175 to 20.43 gpm/ft (Figure 2-233) due to wave overtopping. Figures 2-234 and 2-235 show the test in progress. No displacement was observed.

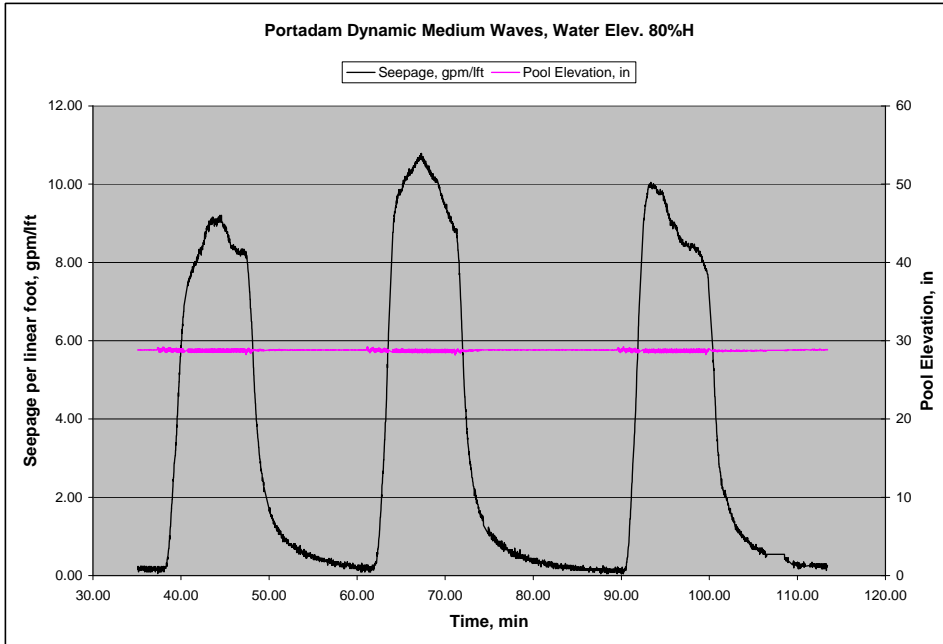

Figure 2-231. Seepage flow rate per linear foot with medium waves at 80 percent pool elevation



Figure 2-232. 7- to 9-in. wave test showing wave overtopping

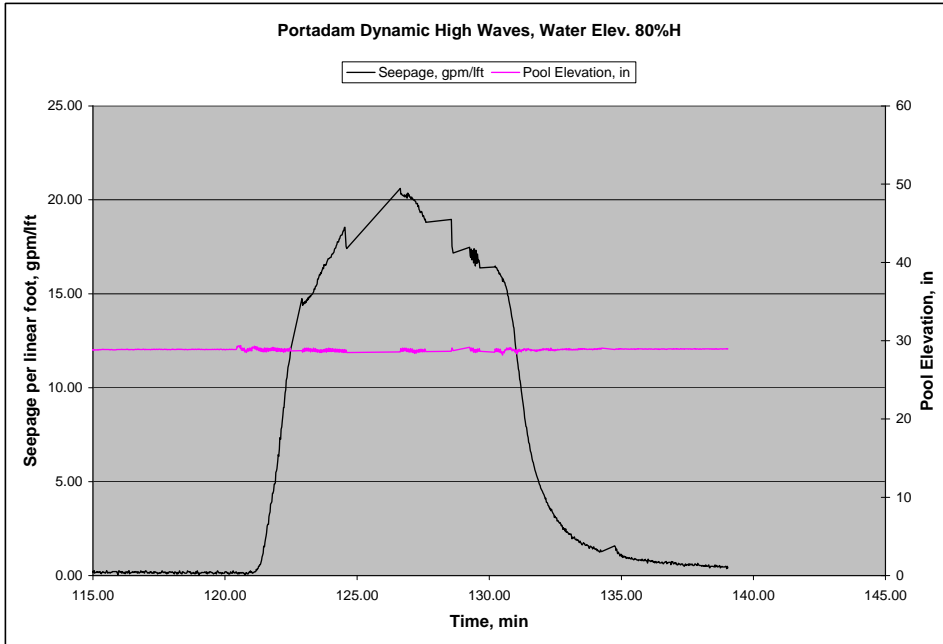

Figure 2-233. Seepage flow rate per linear foot with high waves at 80 percent pool elevation



Figure 2-234. 10- to 13-in. wave test showing wave overtopping along center wall (partial view of impact test apparatus)

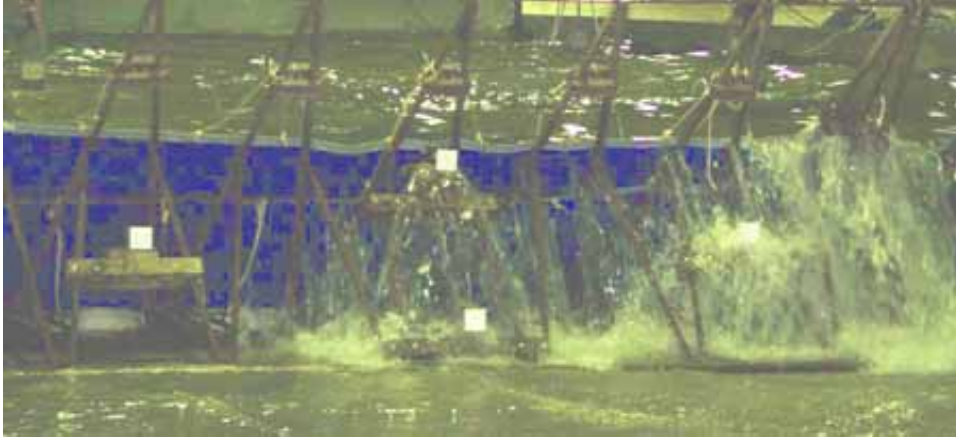

Figure 2-235. 10- to 13-in. wave test showing wave overtopping along center wall

Levee overtopping test

The water level was slowly raised to 40 in. (approximately 1 in. higher than the highest edge of the tarp) and held for 1 hr while overtopping occurred. Total flow rate due to overtopping ranged from 78.8 to 80.3 gpm/ft (5,400 to 5,500 gpm/ft) as shown in Figure 2-236. The large flow can be contributed to the sagging membrane between frames, which makes low points all along the levee. There was no barrier failures were observed during the test. No displacement was noted. Figures 2-237 and 2-238 show overtopping.

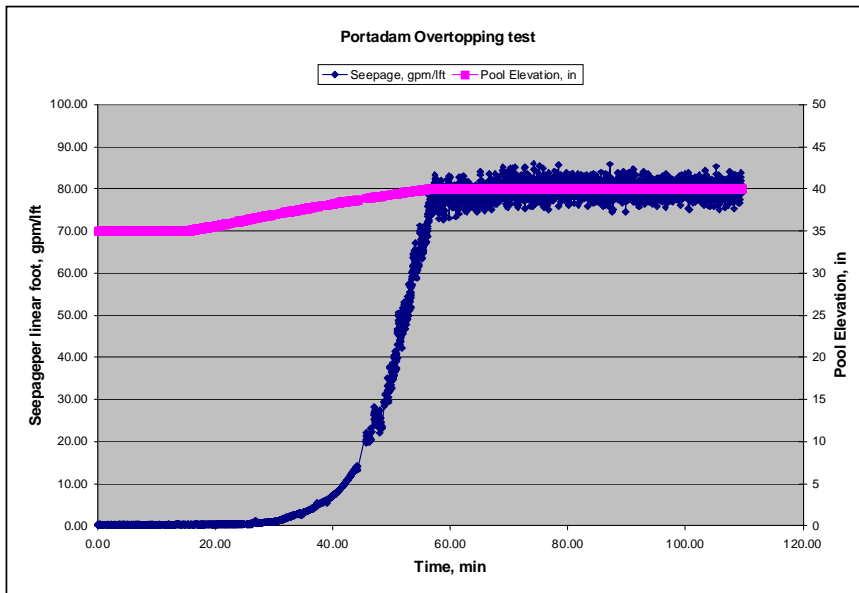

Figure 2-236. Seepage flow rate per linear foot during overtopping



Figure 2-237. View of overtopped left wall



Figure 2-238. Center wall overtopping

Debris impact test

The water level was slowly dropped to the 66 percent height (2 ft) while preparations were made for the log impact test. The small-diameter log (12-in.) struck the tarp (Figure 2-239) and created a one-eighth-in. diam hole (Figure 2-240), resulting in insignificant additional leakage until the larger log impacted the structure as described in the following paragraphs.

The larger diameter log (16-in.) struck the tarp about 3 ft to the left of the trajectory path, and created an 8-in.-long vertical slit (gash) in the tarp at the waterline (Figure 2-241) at a steel frame member. The gash increased the flow rate, but no structural failure or displacements due to impact were observed. Due to the ripstop ability of the vinyl tarp, the slit size did not increase (Figure 2-242), and the inflow seepage remained constant at around 3.5 gpm/lft (Figure 2-243). The seepage due to the tear remained constant until the pool elevation was lowered at the test conclusion, also shown in Figure 2-243.

Maintenance and repair

Repair 1 occurred after the 33 percent hydrostatic test. The remainder of air pockets beneath the apron were flattened out by walking down and/or placing a sandbag on the air pocket. One supervisor took 30 min for this repair (0.5 man-hours).

Repair 2 occurred prior to overtopping. A three-man crew took 30 min (1.5 man-hours) to install additional tarp ties at the abutment walls, and a plugging compound (a 1-gal can of UGL Drylock Fast Plug®) was placed along each abutment wall at the tarp edge.



Figure 2-239. Log impact

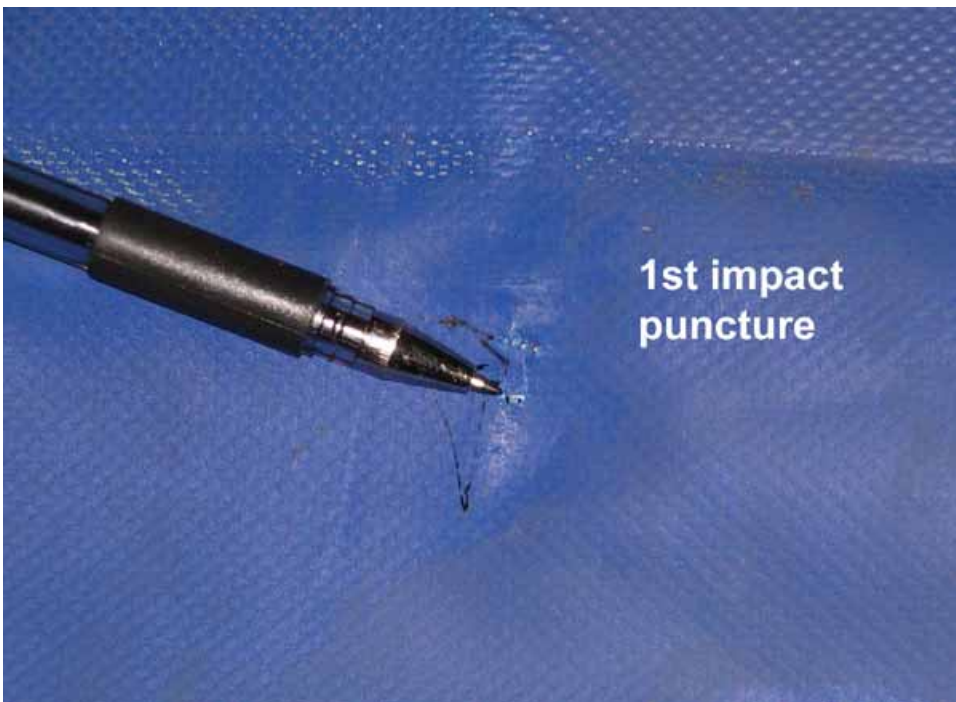

Figure 2-240. Puncture from small log impact



Figure 2-241. Water inflow after large log impact



Figure 2-242. View of gash caused by large log. Note frame member behind slit

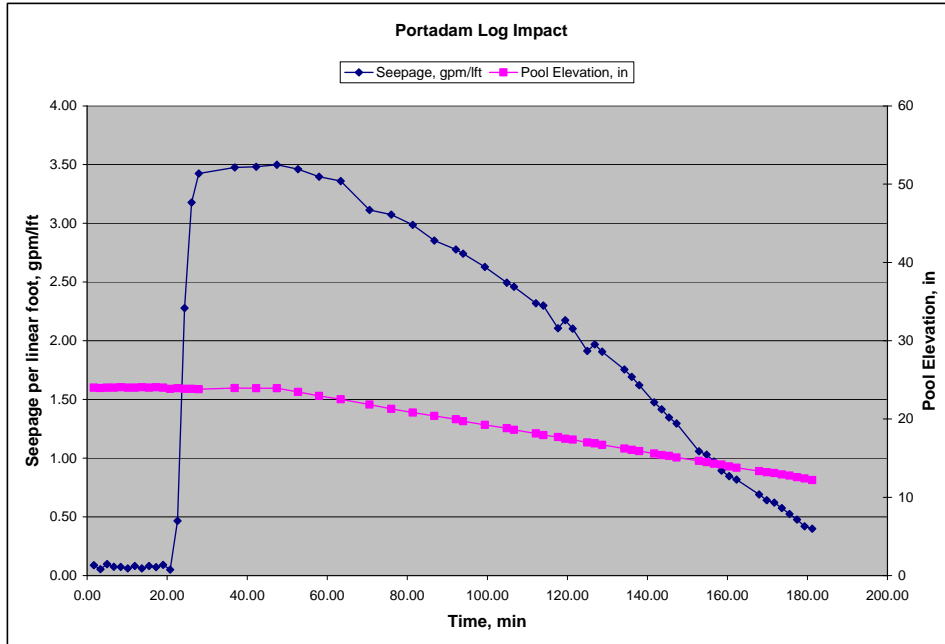

Figure 2-243. Seepage flow rate versus pool elevation (showing after impact leakage)

Repair of the impact damage was not pursued or performed, so Repair 3 was not needed. The Portadam® representative was not onsite during the log impact test, the damage appeared to have no probability of contributing to progressive failure or increased leakage, and a field repair would have served no useful purpose since the testing program had concluded.

Disassembly and reusability

Disassembly essentially was repeating the construction sequence in reverse. A Portadam® representative was not available to disassemble the structure until approximately a month after the testing was completed.

A four-man crew took 1 hr-6 min (4.4 man-hours) to disassemble and remove the structure. Equipment needed was a wrench to loosen bolts and a forklift to carry off the sandbag pallets, tarp pallet, and frame sections.

The disassembly sequence is shown in Figures 2-244 through 2-251. The apron and abutment sandbags were removed, and no damaged units were observed since they were not directly exposed to dynamic loading. The two vinyl tarp sections were disconnected and each section was untied from the frame and rolled up. Dirt residue from the reservoir water was observed covering the tarp surfaces exposed to water.

After the tarp sections were rolled up and removed, the sandbags between the frames were removed. No damaged sandbags were observed. The frame was then disassembled in the reverse order of assembly. The frames were bundled up for reuse.



Figure 2-244. Removing and restacking periphery sandbags



Figure 2-245. Unhooking and separating two vinyl tarp sections



Figure 2-246. Removing vinyl tarp ties from frame



Figure 2-247. Removing vinyl tarp section for restacking on pallet



Figure 2-248. Removing and restacking frame sandbags



Figure 2-249. Disassembling frame brackets with socket wrench



Figure 2-250. Removing top bars for frame removal



Figure 2-251. Restacking frames and collecting bracket hardware for site removal

All components of the PortaDam® structure were observed to be reusable as stated in the company literature, except for the abutment wall minor treatments (expandable foam and sealing compound) and the apron edging duct tape. Due to the log impact damage to the vinyl tarp section, the damaged section will require patching per the manufacturer's suggested method prior to reuse. The PortaDam® system is designed for and is routinely utilized for commercial rental activities, according to their literature.

Environmental aspects

All materials used were nonhazardous and nontoxic. Technical information provided by Portadam® indicated no exposure hazards due to everyday usage of the construction materials. The sandbag fill also presented no exposure hazard.

The polyester cover used for the barrier should be removed from the site and disposed of in the appropriate manner. The material should not be left onsite after the project is completed. If left on the ground, the material would prevent vegetation from growing and could contribute to erosion of the bare soil. The steel structure should be removed and either packaged for reuse or discarded in the appropriate manner if it is deemed to not be used again.

Since there are no fill materials (other than the minor quantity of anchoring sandbags), there should not be any significant contamination concerns due to water-soluble or suspended contaminants present in the floodwater. The presence of floating oil may pose a problem for decontaminating and/or disposal of the vinyl tarp.

If heavy equipment is used for the construction of the barrier, care should be taken to reduce the impact to the area. Upon completion of the project, the ground surface should be restored to the original conditions. This would help to prevent erosion of the soil in the area and allow vegetation to grow back on the area.

Summary and Conclusions from Laboratory Tests

Caution about product selection

Test results are presented here to provide a basis for evaluating and selecting the product that best meets given requirements. Comparative graphs of construction times, removal times, and seepage values for the various structures are shown. Tables with effects of impact damage, product reusability percentages, and environmental concerns are presented. One concern that the reader should focus on is the removal time. The Corps often works with the Federal Emergency Management Agency (FEMA), state, and/or local governments in an emergency. Flood-fighters are willing to help as the flooding is active. Volunteers and funding are normally available to construct any of the flood-fighting products tested. These volunteers and funds are not always available for removal of the materials. If the products are valuable, removing the product becomes more important.

Summary of laboratory tests

Full-size levees (flood-fighting barriers) with approximate dimensions of 62-ft length by 3-ft height were constructed, tested, and evaluated in a laboratory wave basin.

Identical tests were conducted for each levee. Water was impounded at 33 percent, 66 percent, 80 percent, and 95 percent of levee heights to test the effects of controlled hydrostatic and hydrodynamic loadings that simulated actual flood conditions. Log impact tests were conducted at a water elevation of 66 percent levee height to model the impact of waterborne debris against the levee during a flood. During all flood simulation tests, each levee's performance was monitored for seepage, lateral deflection, material loss, and material failure.

Four levees were constructed, tested, and removed in this order: USACE sandbags, fabric-enclosed sand baskets (Hesco Bastion Concertainer®), plastic-grid-enclosed sand elements (RDFW®), and membrane-covered frames (Portadam®). Construction details including labor and equipment requirements were noted. After testing was completed, each levee system was disassembled and removed from the laboratory. Figure 2-252 compares man-hours required for construction and removal of each barrier type.

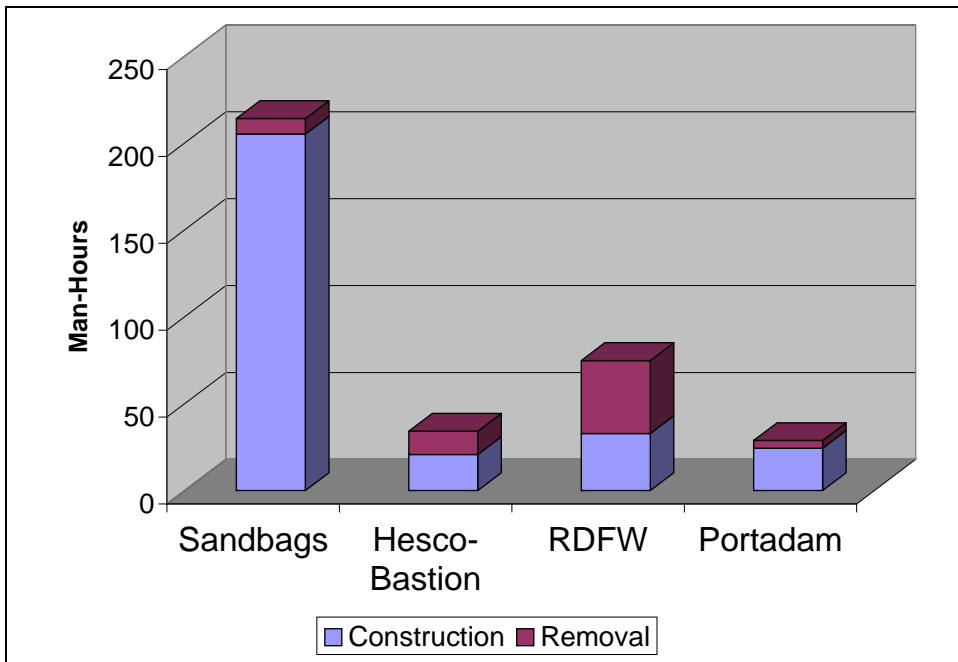

Figure 2-252. Labor man-hours for each levee system

Each 3-ft-high levee system successfully withheld quiescent floodwaters up to a water elevation of 3 ft. As the hydrostatic water levels increased from zero to 95 percent of levee height, the seepage flow rates through the levees ranged from approximately 0.1 up to 1.8 gpm/ft. No appreciable dimensional changes in the levee were observed at any time during the hydrostatic tests, which indicated that each structure's stability safety factors against sliding and overturning were adequate. Figure 2-253 shows seepage flow rate comparisons for each levee system during the hydrostatic tests.

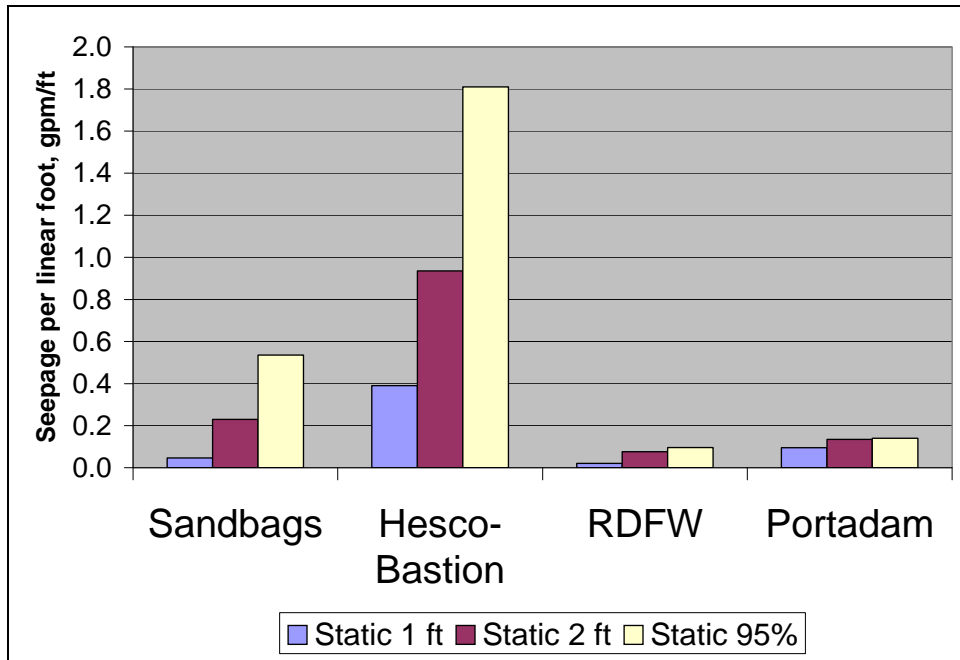

Figure 2-253. Seepage flow rate comparisons for hydrostatic tests

Each levee also successfully withheld floodwaters with wave heights up to 13 in. while sustaining water levels up to 80 percent of levee height. No appreciable dimension changes were noted during the hydrodynamic test. Seepage flow rates significantly increased due to the additional incoming water splashing over the levee top. Figure 2-254 shows seepage-flow rate comparisons during hydrodynamic testing at 66 percent water height for the small waves (2-3 in.), medium waves (7-9 in.), and high waves (11-13 in.). Figure 2-255 shows comparisons at the 80 percent water height. Figures 2-253 and 2-254 show that shape seems to play a part in overtopping. The structures with square cross sections (Figures 2-254 and 2-255) tend to have less overtopping than the structure with sloped sides. The waves tend to run up the slope and over the top of the structures. RDFW (square cross-sectional levee product) has a low bench at its front edge, which caused greater overtopping during the dynamic wave test than did the other square cross-sectional product.

Each levee system was repaired during testing as allowed in the testing protocol. Up to three separate repairs were allowed during the testing program, and the labor man-hours and equipment requirements were noted. Figure 2-256 shows the labor man-hour comparisons for each levee system, with the number of repairs accomplished.

Table 2-1 summarizes the damage sustained by different products. Table 2-2 summarizes the reusability of the products as a percentage after being installed, tested, and disassembled. Table 2-3 summarizes the hazards caused by the material itself, and what can make the levee products become hazardous after being in contact with contaminated floodwaters.

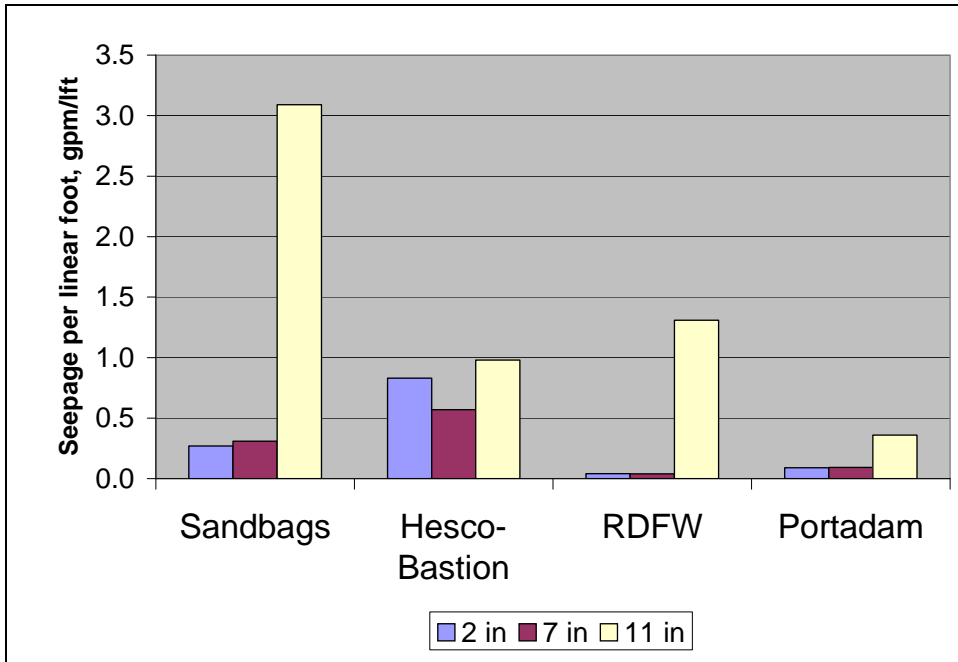

Figure 2-254. Hydrodynamic wave testing at 66 percent water elevation

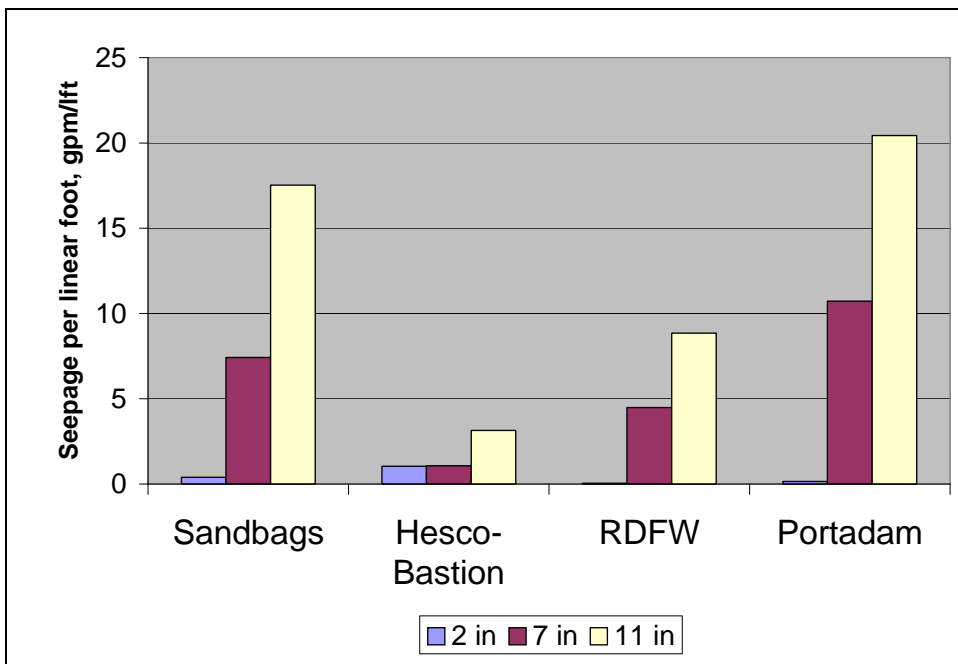

Figure 2-255. Hydrodynamic wave testing at 80 percent water elevation

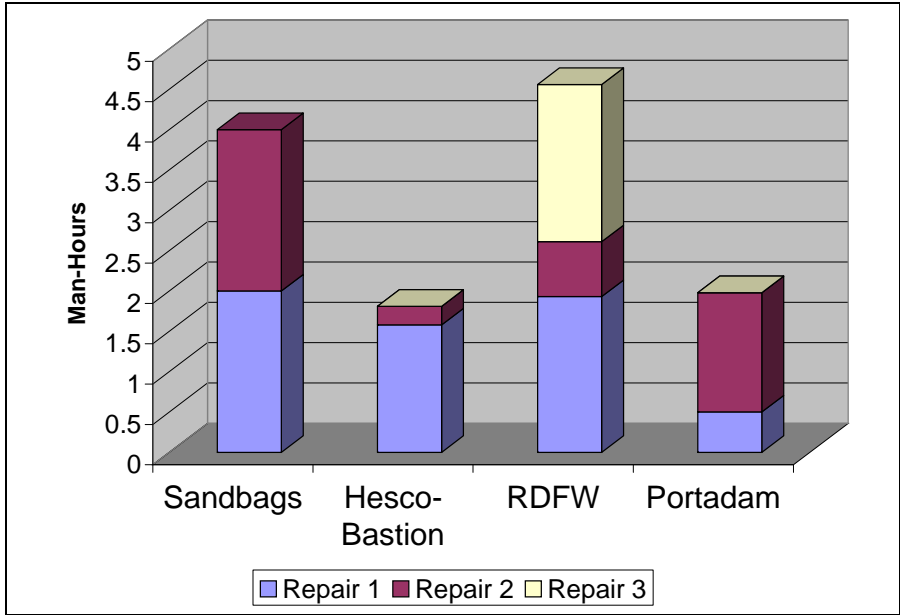

Figure 2-256. Repair labor man-hour comparisons

| Table 2-1 Summary of Log Impact Damage | |
|---|---------------------|
| Sandbags | No damage |
| Hesco® | No damage |
| RDFW® | No damage |
| Portadam® | Vinyl tarp puncture |

| Table 2-2 Summary of Estimated Product Reusability Immediately After Disassembly | |
|---|--------------|
| Sandbags | 0% reusable |
| Hesco® | 99% reusable |
| RDFW® | 90% reusable |
| Portadam® | 99% reusable |

| Table 2-3 Summary of Environmental Concerns | | |
|--|-----------------|---|
| Product | Material Hazard | Contaminated Floodwater Hazard |
| Sandbags | None | Contaminated sand and product exposed surface |
| Hesco® | None | Contaminated sand and product exposed surface |
| RDFW® | None | Contaminated sand and product exposed surface |
| Portadam® | None | Contaminated product exposed surface |

3 Site Selection, Characterization, Instrumentation, and Field Testing

Selection Criteria for Field Test Site

A dependable source of floodwater was the principal site requirement for testing the four flood-fighting barriers in the field. The project could succeed only if the barriers were installed where they would be subjected to natural high water during the spring or early summer of 2004. Many other field-site criteria were considered. These include but were not limited to the following:

- a.* An area under the control or ownership of the Corps was preferred, so that no right of way or easement was needed, the work area was fenced and secure, and access was guaranteed at the critical time prior to, during, and following a predicted high-water event.
- b.* A large work crew and heavy construction machinery had to be available nearby.
- c.* Access via paved road was preferred to provide vehicle access for field installation teams and equipment.
- d.* Rather than being on top of a levee or on a paved road or parking area, the location for installing the barriers should be on a natural surface, such as turf or mud, simulating the wet conditions of many flood fights.
- e.* Adequate space for the four barriers and the requisite working space between them were essential.
- f.* Surface and shallow-subsurface conditions had to be demonstrably similar at the spaces provided for all four barriers.
- g.* The site had to be clear of surface or subsurface trash that would create discontinuities to confound geophysical site characterization, as well as potentially hinder barrier installation and create seepage pathways.
- h.* Because of the need to subject the barriers to a natural flood, the field site had to be located where accurate river-level predictions were available, and where a high-water event was expected during the spring or early summer.
- i.* The preferred barrier geometry was a U-shaped structure with the wing walls tied into a sloping bank, for which a sloping field site was essential.

To meet the project requirements in the brief time allowed and avoid travel costs for the Project Delivery Team (PDT), a site was chosen just north of Vicksburg, MS, that met all of these requirements. The selected field-test site is located on the southern bank of the turning basin of the Vicksburg Harbor, on the water side of the enclosing dike. Figure 3-1 shows the study area, with the main channel of the Mississippi River in the lower left. The turning basin is directly connected to the River via the Yazoo Diversion Canal, and experiences backwater from the high-water events of the Mississippi River.

Required Activities and Limitations for Field Demonstrations

The principal activities required for demonstrations of the three commercial flood-fighting technologies and sandbags were to construct a 3-ft flood barrier, and then raise the barrier by 1 ft after the structure was fully installed. The principal limitation was to work within the 25-ft right of way defined for each structure-assembly site. Details of the requirements and limitations are given in Appendix A.

Although the river level was falling at the time the barriers were installed at this site, a high-water event was expected for early June that would inundate all four barriers as planned. The following sections describe characterization of the site using penetrometer and geophysical methods, the field-instrumentation array, and installation and performance of the four types of flood barriers.

Characterization of Field Demonstration Site

Test site location

The selected test site is located on the southern bank of the turning basin in Vicksburg Harbor, between the levee and the basin (Figure 3-1). The turning basin is situated to the northeast of the Yazoo Diversion Canal in Warren County, MS, at Mississippi River Mile 437 on the left descending bank of an abandoned channel of the Yazoo River.

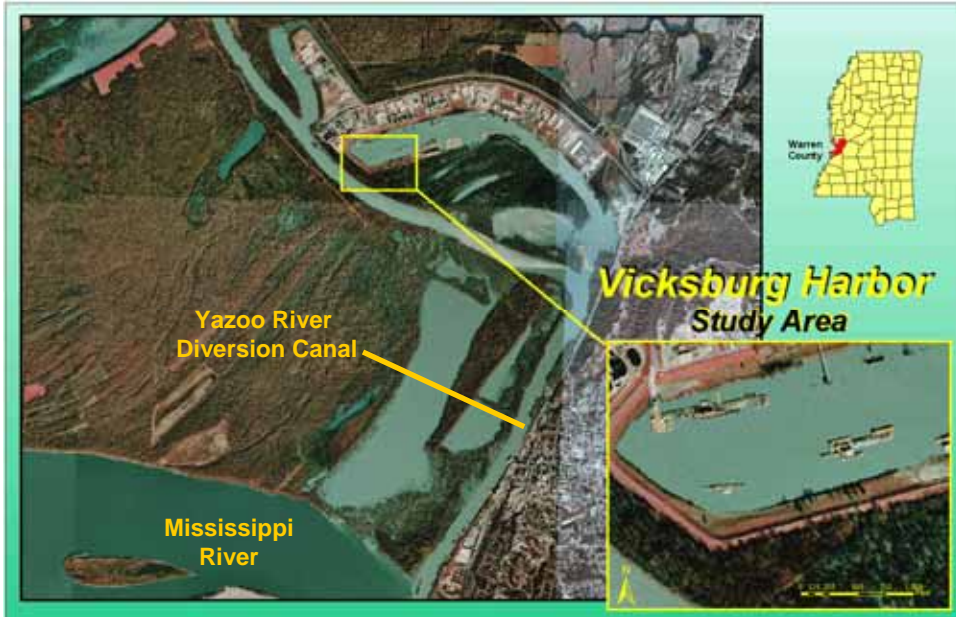

Figure 3-1. Location of field test site at Vicksburg Harbor

The Vicksburg Harbor turning basin was constructed by conventional hydraulic dredging in abandoned channel sediments (Figure 3-2). The sediments were dredged from the abandoned channel and pumped to the north side of the basin to drain and settle, forming the higher ground on the north side of the turning basin (George Sills 2004)¹. The maximum length of the turning basin is one mile, the maximum width is 300 ft, and the mean depth of the channel is 12 ft (<http://www.mdot.state.ms.us/ports/VickHome.htm>).

Geologic setting

The Vicksburg Harbor is located in the southern portion of the lower Mississippi Alluvial Valley. The geologic materials in the area consist of Mississippi River Valley alluvium of Quaternary Age. The alluvium was deposited unconformably on an eroded Tertiary surface within the meander belt of the Mississippi River (U. S. Army Engineer District, Vicksburg, 1990). The alluvium consists of mainly sand, silt, clay, and gravel that has been reworked into abandoned course, abandoned channel, point bar, and back swamp deposits. The finer grained alluvium (abandoned channel and back swamp deposits) often serves as an aquitard to groundwater movement.

The surficial sediments or topstratum in the area are a mixture of point bar and abandoned channel deposits. Point bar deposits develop during high stream stages in zones of low turbulence and velocity along the convex side of a migrating streambed (Hickin 1974). Abandoned channel deposits develop as short channel segments become disconnected from the main stream by a neck or chute cutoff. Fine-grained, clayey sediments settle in the abandoned channel and eventually form a “clay plug.”

¹ Sills, George. (2004). Personal communication in the Geotechnical and Structures Laboratory.



Figure 3-2. Abandoned channel area in 1955, previous to turning basin construction

The topstratum, with an average thickness of 25 ft, consists of brown to gray silty sand (SM), silt (ML), silty clay (CL), clay (CH), and fine sands (SP). The substratum, with an average thickness of 80 ft, is mainly composed of sand (SP) with a few deeper gravelly deposits near the lower contact. Due to the variation in thickness of the topstratum, the substratum may be as close to the surface as 5 ft in certain locations (U. S. Army Engineer District, Vicksburg, 1992).

Methods and results

The objective of the study was to identify a site where the subsurface differences are minimal and unlikely to cause variation in product installation and performance while still representing the natural conditions in which these products will be used. A series of tests was conducted on the field site to define surface and subsurface materials, engineering characteristics and to establish the relative homogeneity through the area where the innovative flood-fighting products would be tested. The techniques selected represent the current best practice in site characterization. Techniques used to select the site included the following:

- a. Visual inspection.
- b. Dynamic (dual mass) Cone Penetrometer (DCP).
- c. Cone Penetrometer Test (CPT).
- d. Geophysical survey.

Visual inspection. A visual inspection of the surface conditions in the turning basin was performed to determine the most suitable locations for field testing. Considerations included accessibility to the site as well as size, elevations, slope characteristics, and homogeneity. The study area was divided into nine sections. Each section was measured and surface elevations were approximated from the Mississippi River at Vicksburg gage readings (Figure 3-3). Of the nine sections inspected, eight were adjacent to one another and located on the southern side of the turning basin and were relatively similar, with gentle slopes from the toe of the levee towards the water. Only one section (Jadwin) located at the north side of the turning basin, presented a noticeably different and steeper slope.

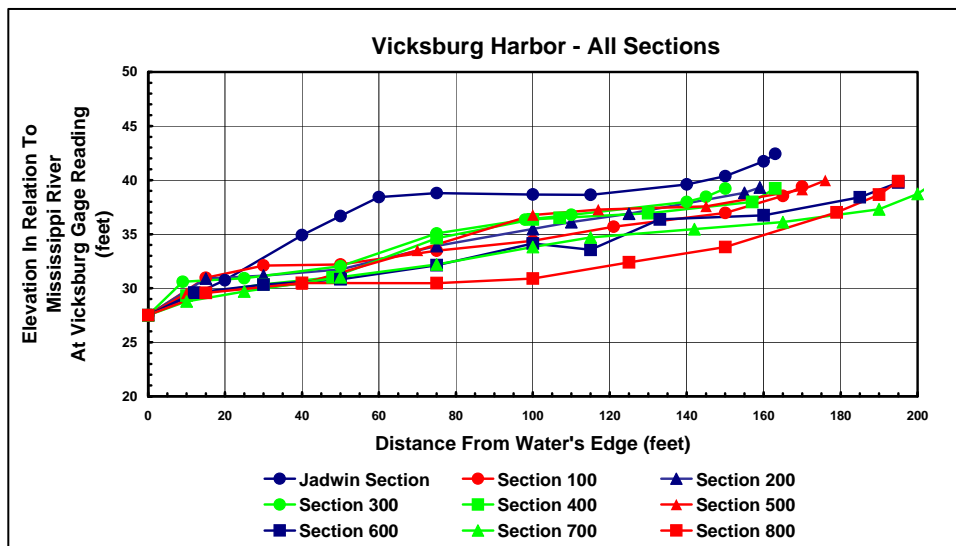

Figure 3-3. Vicksburg Harbor elevation profiles

Dynamic Cone Penetrometer (DCP). DCP is commonly used to evaluate in situ strength of pavement base, subbase, and subgrade materials. DCP testing is used here to identify the thickness of the surface soil layer and to estimate stiffness of the upper 2 to 3 ft. The DCP consists of a 10.1-lb hammer that drops 22.6 in. and hits an anvil, sending a cone-tipped five-eighths in. diam rod into the soil. A ruler is used to measure the distance the rod sinks into the soil in millimeters. DCP measurements are recorded as a Dynamic Penetration Index (DPI):

$$\text{DPI} = \text{depth} / \# \text{ of blows for cone-tipped rod to reach that depth}$$

Correlations between DPI and a soil strength value known as the California Bearing Ratio (CBR) have been developed. CBR is the soil-strength value used for designing and evaluating subsurface materials for military roads and airfields (Webster et al. 1992). Soil bearing capacity is the maximum value of the load or stresses that can be imposed on the ground before the soil fails or yields. Differences in soil load bearing capacities may be due to variations in composition of the natural material, differences in density, or moisture content (Scott and Schoustra 1968). These characteristics may provide small-scale variations in confinement and lateral support.

Five DCP measurements were taken from the eight visually inspected and selected sections on each of the four anticipated footprints. The measurements were interpreted according to the database developed by ERDC technicians from numerous sites and different soil types (Webster et al. 1992). Results placed the near-surface material in the range of clays (CH) and silty clays (CL).

A general tendency in the study area is a slight increase in material strength with depth and proximity to the toe of the levee. However, the surface layers closest to the levee and to the east side show a decrease in strength with depth. Also, from the middle to the west side of the testing site, the DCP data indicate a stronger layer within the center of the footprints at a depth between 15 to 25 in. below the surface. The bearing capacity range of the area goes from 800 to 1,400 lb/ft² in the surface layers closest to the levee and to the east side, decreasing to lower values with depth. From the middle to the west side of the testing area, the soil bearing capacity increases with depth up to 4,400 lb/ft² between 15 to 30 in. below the surface. Based on GSL experience, this should suffice for the loads expected. The bearing capacity values seem to be within the range needed for the installation of the different products to be tested. The areas with higher CBR and bearing capacities would indicate more compacted or coarser material layers.

Cone Penetrometer Test (CPT). The Cone Penetrometer Test (CPT) is a subsurface soil exploration method that involves pushing a conical-shaped probe into a soil deposit (clays, sands, or soil mixtures with little or no gravel) and recording the resistance of the soil to penetration. CPT measures mechanical properties (e.g., sleeve friction, penetration stress, and pore fluid pressure) that are used to infer soil types by means of mathematical interpretation. Sampling is done as the device is hydraulically pushed into the ground, resulting in a well-log-type profile of the subsurface lithologies.

The CPT has three main applications which include:

- a. To determine subsurface stratigraphy and identify materials present.
- b. To estimate geotechnical parameters.
- c. To provide results for direct geotechnical design.

The CPT is used here to identify the site stratigraphy and corroborate its relative homogeneity within the testing area. One CPT was done in the center of each of the selected footprints down to a depth of approximately 20 ft. The resulting stratigraphy shows an upward fining sequence that could be expected in natural fluvial deposits where finer sediments are deposited over coarser sediments in discontinuous layers. The upper 2 to 6 ft are identified as clays to silty clays (CL), which coincides with the DCP data. These fine sediments are thinner (2 ft) around the center of the testing site, thickening to the east (3 ft) and west (6 ft). Several thin layers with higher strength are identified close to the surface in CPT-4 (last to the west) that could account for the higher strength values obtained with the DCP tests. Alternating layers of sandy silt to silty sand of varied thickness lay beneath the upper fine deposits. Also, a stiff layer below 16 to 18 ft is present and consistent through all the CPT measurements.

Geophysical survey. A relationship between geophysical data and soil types determined by cone penetrometer tests (CPT) has been established previously (Olsen 1994; Endres and Clement 1998). The CPT profiles provide information about subsurface composition and interfaces that can be useful when combined with near-surface geophysics in site characterization (Wyatt et al. 1996; Clement et al. 1997a,b). A geophysical survey was used to define the continuity of geologic composition between CPT locations.

The instrument selected for this investigation was the Geonics EM-31 single frequency electromagnetic (EM) meter. This investigation assessed geological variations and any subsurface features associated with changes in the ground conductivity. The ERDC-GSL geophysical survey was conducted in April 2004.

The Geonics EM-31 single frequency EM meter does not require electrical contact with the ground and thus provides rapid measurement of terrain conductivity. The instrument is designed for geophysical applications down to depths of 6 m. A transmitter coil located at the end of the instrument induces eddy current loops into the ground. The eddy currents in turn generate a secondary magnetic field proportional to the magnitude of the eddy current flowing within that loop. The resulting voltage obtained from the magnetic field is linearly related to terrain conductivity. The EM-31 can be operated in both a horizontal and vertical dipole orientation with different effective depths of exploration, and in continuous or a discrete mode.

A perimeter that surrounded the testing site was marked. The survey grid of 180 m × 42 m was flagged for the EM-31 survey. A total of 21 EM-31 conductivity profile lines were surveyed. The EM-31 survey was run in a northeast-southwest direction at 2-m spacings between the lines with fiducial markers approximately every 50 m for fixed points of reference along the lines. Readings were stored in a hand-held field computer. The turning basin that flooded the site is on the northern side of Figure 3-4 and the toe of the levee is on the southern side. Figure 3-4 shows the location of DCP tests and CPT that were conducted at this site.

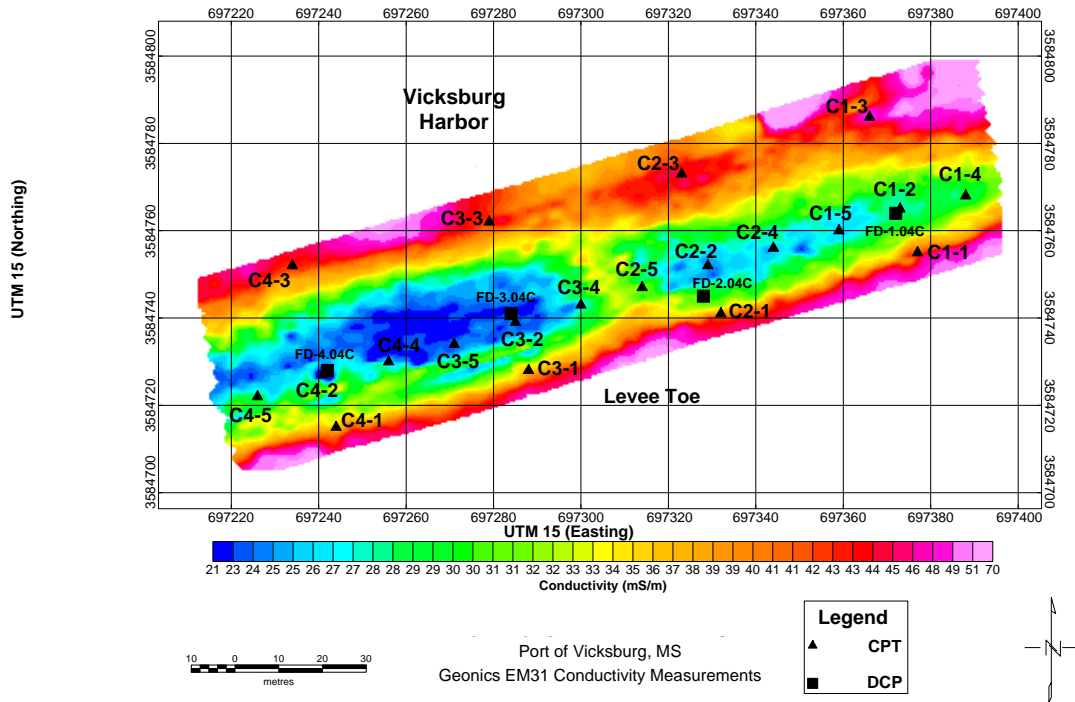

Figure 3-4. EM-31 data with DCP and CPT locations

The EM-31 data showed an area of low conductivity responses in the mid-west section of the grid between CPT locations C3-2 and C4-2 (Figure 3-4). The area with low conductivity values is located approximately 12 m from the toe of the levee on the southwestern boundary area of the survey grid. The low conductivity value area is located between approximately (697290, 3584745) and (697250, 3584730). Another area of values shows low conductivity values between approximately (697350, 3584755) and (697330, 3584750). The areas with the higher conductivity values on the riverside of the survey grid correspond with an area where braided steel cabling was visible on the water's edge near C4-3, C3-3, and C1-3. The areas with the higher conductivity values on the toe side of the survey grid could possibly be buried water pipes or telephone lines. Locations labeled (FD1.04-FD4.04) are DCP tests. Location FD2.04 C has low conductivity values possibly associated with sandy silt to clayey silt soil types. Location FD1.04 C has low conductivity values possibly associated with clayey silt to sandy silt soil types. Location FD3.04 C has layers consistent with clay material down to 6 ft but possibly silty clay to clayey silt thereafter.

Conclusions

Eight of the nine geologic sections had similar lithologies. Further, they had a common gentle slope from the toe of the levee toward the water. The general tendency is a gradual increase in surface soil strength with increased depth and proximity to the toe of the levee. A high strength layer within the center of the footprints occurred at a depth between 15 to 30 in. below the surface. This layer decreases in strength with depth and is not consistent or at the same depth on the eastern part of the site. Bearing capacity values should suffice for the loads expected and are within the range needed for uniform installation and testing of the different products.

Correspondence between DCP and CPT results. The stratigraphy displays a fining-upward sequence with clays and silty clays present in the upper 2 to 6 ft of soil. Several thin layers of higher strength are identified close to the surface in CPT-4 (last to the west) and could account for the higher strength values obtained with the DCP tests in this area. Additionally, there seems to be a stiff layer below 16 to 18 ft that is consistent through all sites.

Geophysical survey and CPT results. Results of the survey revealed an area of low conductivity values between approximate grid station (697290, 3584745) and (697250, 3584730) on the southwestern boundary area of the survey grid. There was also an area indicated between (697350, 584755) and (697330, 3584750) with low conductivity values. The low conductivity could possibly be due to higher water content or higher clay content. Further CPT testing could be conducted at specific locations to clarify subsurface conditions at areas that have higher conductivity values.

The areas with the higher conductivity values on the riverside of the survey grid are where braided cabling was visible on the water's edge near C4-3, C3-3, and C1-3. The areas with the higher conductivity values on the toe side of the survey grid could possibly be water pipes or telephone lines. Location FD2.04 C has low conductivity values associated with sandy silt to clayey silt soil types. Location FD1.04 C has low conductivity values associated with clayey silt to sandy silt soil types. Location FD3.04 C has layers consistent with clay material down to 6 ft but then has silty clay to clayey silt thereafter.

In Figure 3-5, each of the flood control structures can be seen in place over homogeneous material as evidenced by the geophysical data. The turning basin area is a suitable location to test the different flood-fighting technologies in a natural yet homogeneous condition due to its location, the source of its geological material, and the processes used to construct the dike.

Field Test Instrumentation

Introduction

Instrumentation was designed to address three major aspects of the field testing. A camera system recorded a complete time-history of all construction, testing, and removal of the flood-fighting structures. The second need was to measure and monitor water levels in the sumps and against the structures. The third major instrumentation array was designed to monitor dimensions of the structures. This section describes the design and use of these three instrumentation arrays in the field.

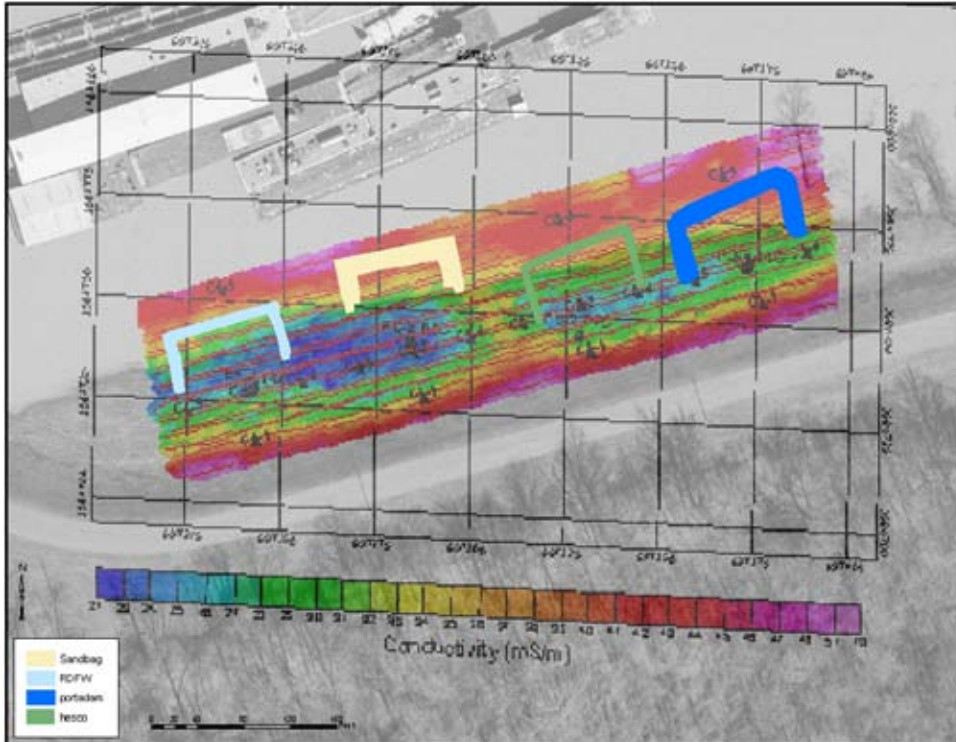

Figure 3-5. Flood control structures in place over geophysical data

Video monitoring

The large size of the project required designing a monitoring system that could capture visual views from different angles. Typical video surveillance cameras use a scan-line technology in an analog mode. The images are rather coarse and fine resolution changes are difficult to distinguish. It was decided to install a video monitoring system that could capture digital images at a much finer resolution at short time lapses. StarDot® cameras with 1.2 megapixel resolution were chosen for this application. Figure 3-6 shows the digitally addressable (remote controllable) camera with motorized zoom lens. This camera is network-capable and has complete function control through a Web interface graphical user interface (GUI). The focus, image size, brightness, motion detection, image labeling, and frame rate are controlled through this GUI. A commercially available Digital Video Recording (DVR) software package was also used.

StarDot® DVR software with StarDot® networked cameras allowed video monitoring and recording with a desktop personal computer (PC). Each camera was remotely controlled from an onsite instrumentation trailer. Individual images were recorded to the hard drive in Joint Photographic Experts Group (JPEG) format in a video database. The files were then exported to an Audio Video Interleave (AVI) file format from the hard drive for any chosen period of time that data were collected. The user has a choice of the screen layout and position of each camera. Figure 3-7 is an example screen for a seven-camera layout. The camera location on the screen along with view name and image tagging is completely controllable by the user. Each view during the tests was labeled with the site name, time, and date for the image. This provided a complete time-history of all construction and testing activity at the site.



Figure 3-6. StarDot® 1.2 megapixel net camera



Figure 3-7. Example DVR software screen

Functions of the DVR software include the following:

- a. Instant search and playback of JPEG images in a video format.
- b. Old recordings are automatically deleted if hard disk becomes full.
- c. Using motion-detect mode, months of video can be stored on a typical hard disk.
- d. Export to AVI video for CD-ROM archiving.
- e. Playback video forward or backward up to 1,000 × normal speed.

For the field tests, a total of eight cameras (two per camera mount) monitored the four sites during testing. Figure 3-8 shows the camera layout during the construction phase and the beginning of the testing phase for the project. Figure 3-9 shows the layout for the testing phase after the sandbag structure testing was completed, and Figure 3-10 shows two views of one of the four camera mounts.

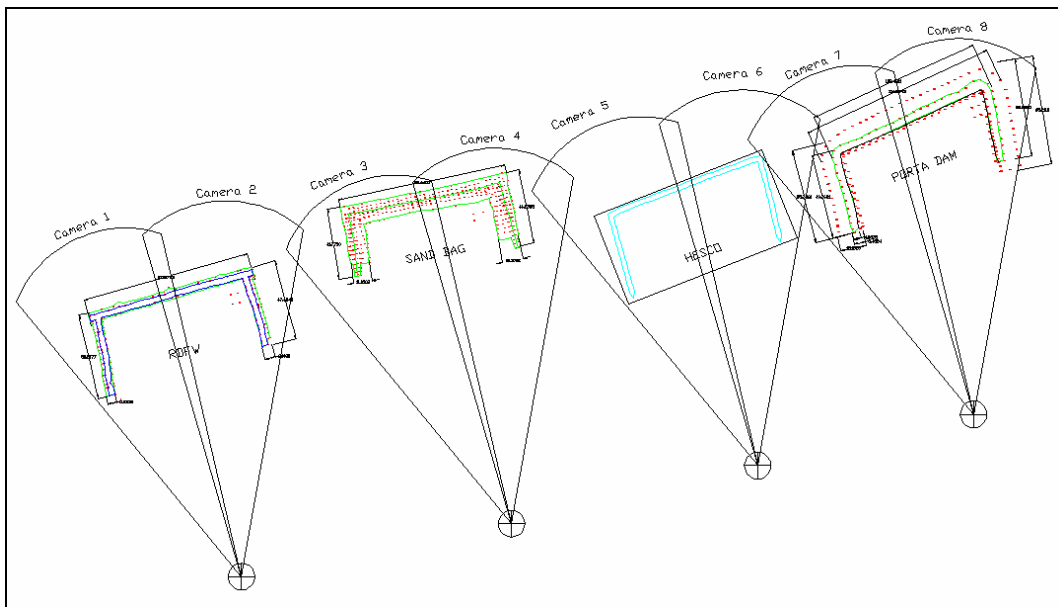

Figure 3-8. Camera layout for construction phase and beginning of test phase

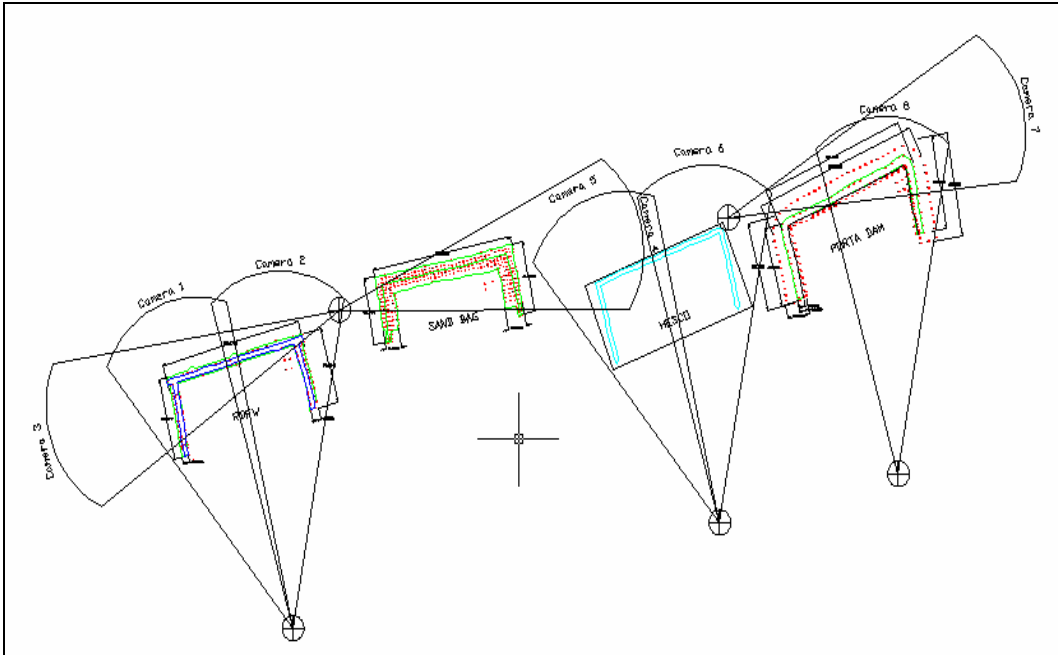

Figure 3-9. Camera layout after sandbag structure was inundated



a. Side view



b. Rear view

Figure 3-10. Typical dual camera mount

Water level monitoring

Water level gages and sensors. Concrete sump pits were installed on the protected side of each structure for capturing and measuring all of the seepage water. In each sump, staff gages were placed to monitor the water level change in the sump visually. The pump operators timed the level change and called the data back to the data-acquisition trailer to be recorded in the test log. The electronic level sensors provided a secondary backup to the timed method for calculating the seepage rate. When the seepage rate dramatically increased, the sumps would fill in 20 to 30 sec. Figure 3-11 shows one of the four concrete sumps with the capacitance water level sensor and the fixed-mount staff gage.



Figure 3-11. Concrete sump with fixed-mount staff gage and capacitance water level sensor

In addition to measuring water level change in each sump pit for seepage rate calculations, the water level change on the outside of each structure was also measured. Figure 3-12 shows two staff gages that measured water level changes throughout the test.

The electronic water level sensor was the OSSI-010-002D Wave Staff unit combining a rugged, sealed, waterproof package with a low-power microprocessor and a temperature-stable circuit. The Wave Staff operates from 5.5V to 40VDC and has analog, RS232 serial data and two alarm outputs. The serial data output string contains the water level and temperatures in ASCII or binary format. The Wave Staff can be programmed to sample continuously or at discrete intervals via a PC serial port using the interfaced software. Figure 3-13 shows the sensor and wiring configuration for the Wave

Staff unit. Two different-length staffs were used to measure water levels during this project. A 2-m staff was used on the outside of each structure while a 1-m staff was used in each concrete sump.



Figure 3-12. Staff gages positioned outside structure for visually monitoring water level changes

Wireless data acquisition transport (WDAT) logging system. The WDAT system consisted of the Data Acquisition Unit (DAU) and the data collection server. The DAU collected the water level sensor data while the server processed and stored the data. Figure 3-14 shows the DAU packaged inside its transport case.

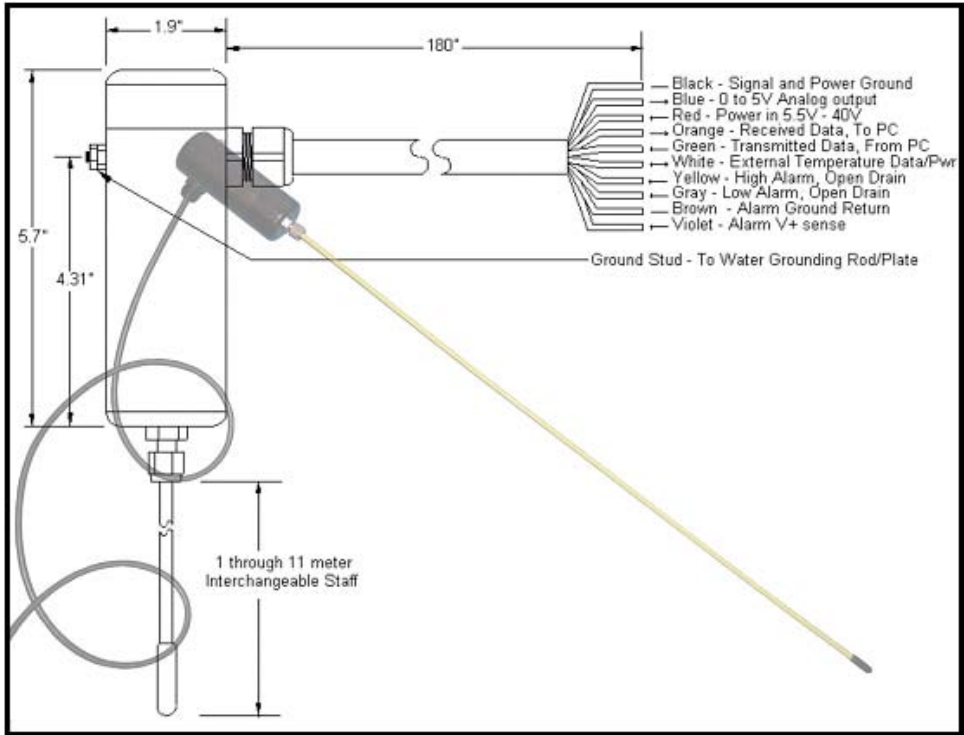

Figure 3-13. Wave staff water level wiring configuration and dimensions



Figure 3-14. Data acquisition unit packaged inside case

The DAU includes the following components:

- a. *Microcontroller*: The microcontroller (MC) is based on an industry standard 386 EX processor running at 25 MHz. The unit has 512 KB RAM and 512 KB Flash storage, and is equipped with 64 MB of flash disk for stand-alone data-logging applications.
- b. *Operating system*: The operating system used on the microcontroller is a proprietary operating system similar to a MS DOS 3.1 version.
- c. *Analog-to-Digital (A/D) card*: This A/D converter card is an 8-channel 12-bit A/D converter board based on the Maxim MAX197 chip. The board features software-selectable input ranges of +/-10V, +/-5, 0 V to 10 V, and 0 V to 5 V. Conversion time is 6 microseconds. The basic A/D converter board has +/-16.5 V input protection and unbalanced inputs.
- d. *Acquisition performance*: The DAU can operate at a sustained rate of 60 samples per second (60 Hz) over all eight channels.
- e. *Wireless device*: The wireless device is based on frequency-hopping spread spectrum (FHSS) technology and designed to IEEE 802.11 wireless LAN standards. It transmits data at up to 2 mbps at a range of up to 2,000 ft/606 m. Its wide temperature range and robust mechanical design deliver reliable performance in the most demanding environments. The performance specifications of the device are as follows:
 - f. *Frequency range*: The transmission frequency range is from 2.4 to 2.5 GHz. It is programmable for different country regulations.
 - g. *Data rate*: The data rate is 2 mbps per channel.
 - h. *Output power*: The transmission output signal power is 500 mW.
 - i. *Power management*:
 - j. *Receive*: 500 mW = 375 mA, 100 mW = 375 mA both @ 5 V.
 - k. *Transmit*: 500 mW = 500 to 675 mA, 100 mW = 450 to 600 mA both @ 5 V.
 - l. *Transmission range*: The transmission range is up to 2,000 ft/606 m in open environments and up to 180-250 ft/54.5-75.5 m in typical office or laboratory space.
 - m. *Operating temperature*: The operating temperature range for the microprocessor is from -5 to 140 deg F or -20 to 60 deg C.
 - n. *Antenna*: The DAU uses a common “rubber duck” dipole whip antenna.
 - o. *Enclosure*: The unit is contained in a plastic enclosure of a rugged waterproof design, intended for field service.
 - p. *Power options*: The unit operates with both AC power, in the form of a supplied small-wall transformer, and battery power. The unit is designed to utilize an external battery and as an option can be configured to use an internal battery as well. A larger enclosure was constructed to encompass a large battery source with solar recharge capacity. Figure 3-15 shows the solar-paneled enclosure’s exterior and interior.



a. Enclosure



b. Battery power supply

Figure 3-15. DAU enclosure enlarged to include battery power supply

The data collection server operates with the current Red Hat Linux operating system. Software used for this application is written in C to run on a Linux-based system. The software will allow remote configuration of the data acquisition units. The parameters configured include sample rate and input-voltage range on each channel. In data acquisition mode, the server collects field data into ASCII files. A file is created for each channel of each data acquisition unit. A new file is created whenever a new session is started or when a pre-defined maximum size is reached. Figure 3-16 shows a WDAT platform typical for each of the four test sites. Elevated stands were constructed to keep the sensitive electronics dry and above traffic at each site. Individual cables were run from each water level sensor to its DAU. The data were transmitted back to the server for processing and storage.



Figure 3-16. DAU mounted on an elevated stand

Structure dimension monitoring

The individual structures were surveyed twice during the testing period. The first survey occurred after construction was complete and the second survey occurred after test completion when the river water had fully receded from the test site. The method of survey used was a total station theodolite referenced to benchmarks at the site. The elevation data were corrected to National Geodetic Vertical Datum (NGVD) 1988. Figures 3-17 through 3-26 represent the survey data and dimensioned layouts for the four structures.

Volume calculations were made for each structure by creating two surfaces from the survey data, using AutoCAD Land Desk Top Developer®. The first surface was created with the perimeter measurements of each structure. The second surface was created using the outside and top measurements of each structure. The software allows the user to display the different surfaces common to the same footprint for calculating the total internal volume. The grid cell size of 1 sq ft was chosen for simplicity. The resulting volume was converted to cubic yards and is shown on the following figures for each structure. All structures except Portadam had an internal volume.

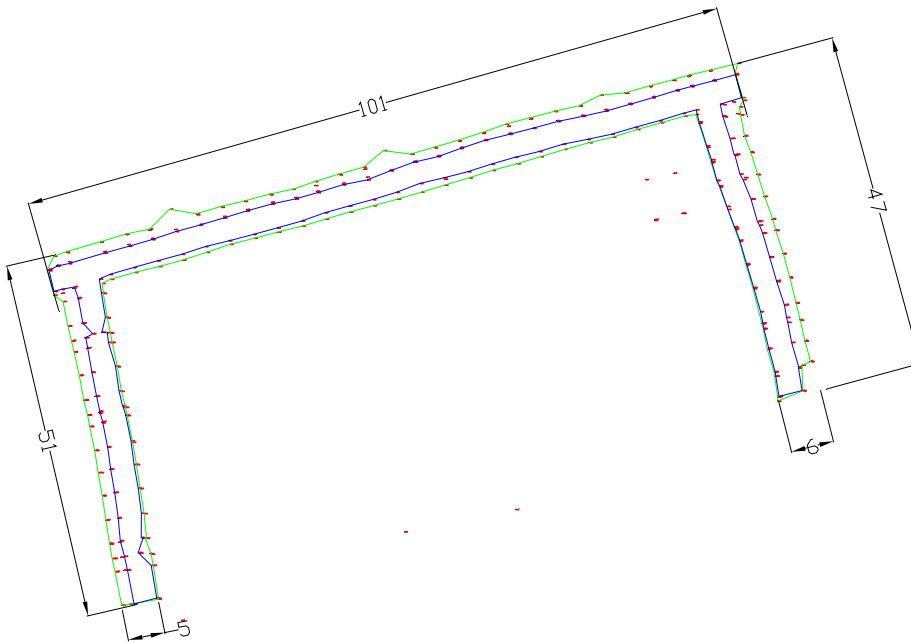

Figure 3-17. RDFW structure dimensions (ft)

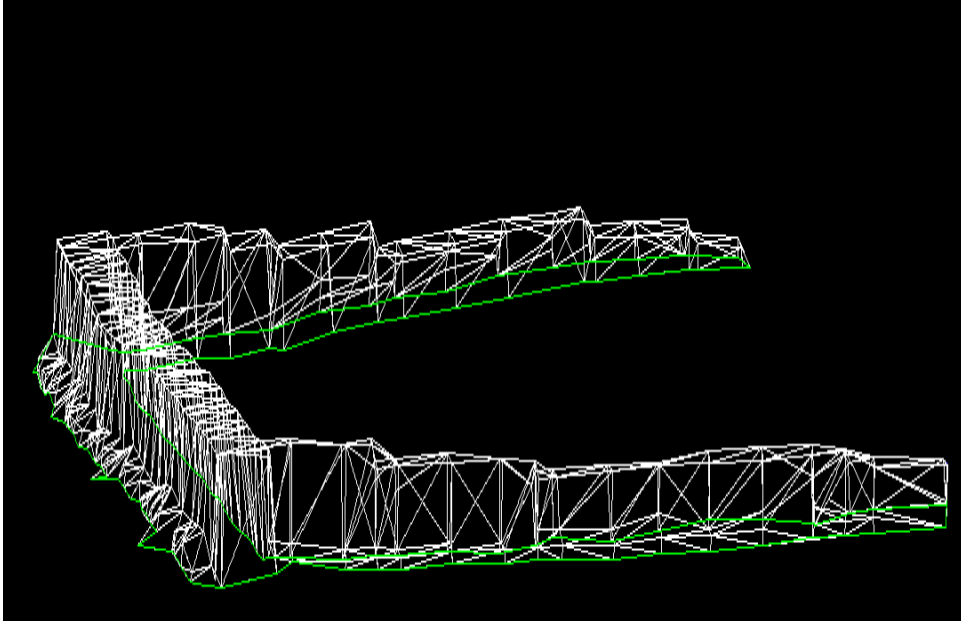

Figure 3-18. RDFW structure side view. Internal volume was 84.9 cu yd

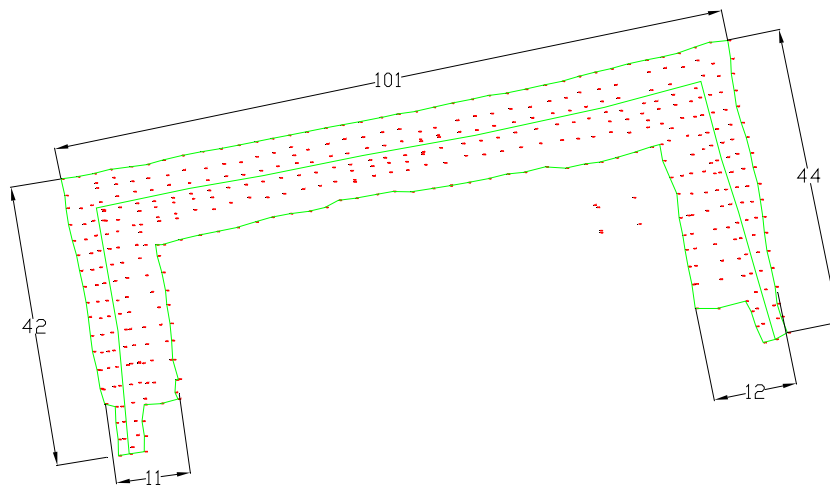

Figure 3-19. USACE sandbag structure dimensions (ft)

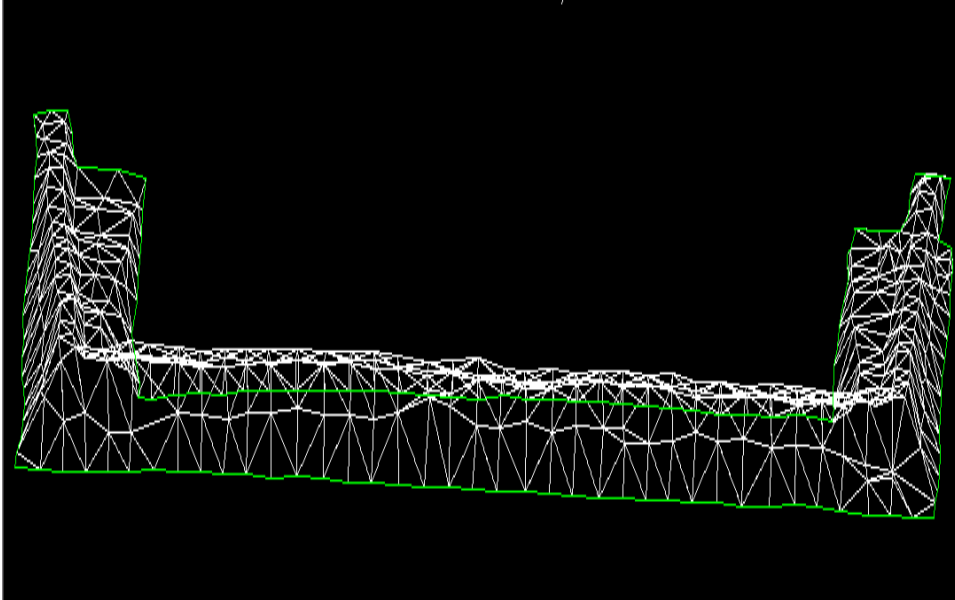

Figure 3-20. Sandbag structure viewed from riverside. Internal volume was 131.5 cu yd

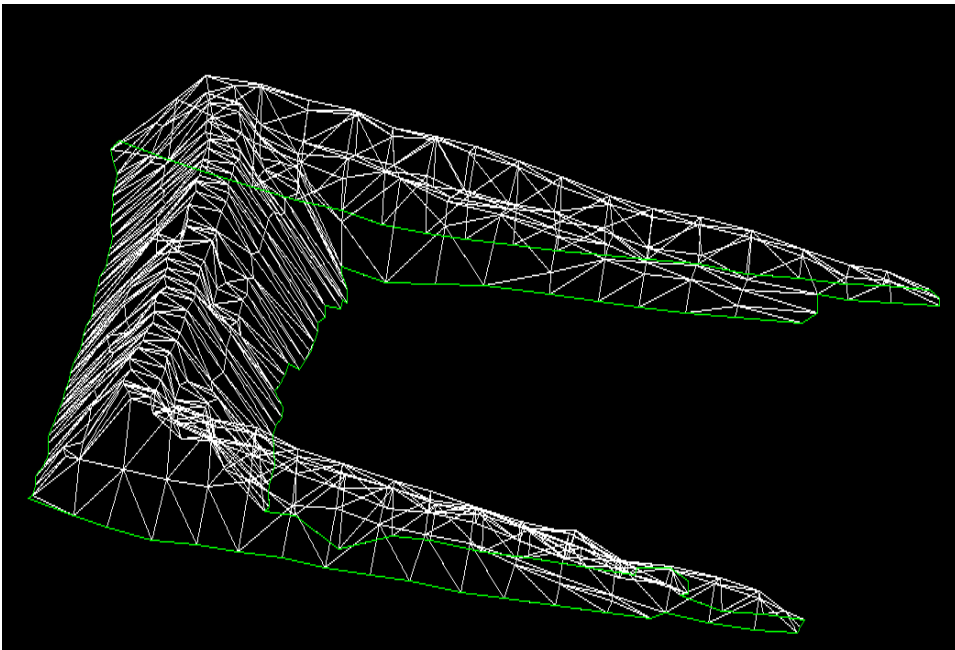

Figure 3-21. Sandbag structure viewed from side

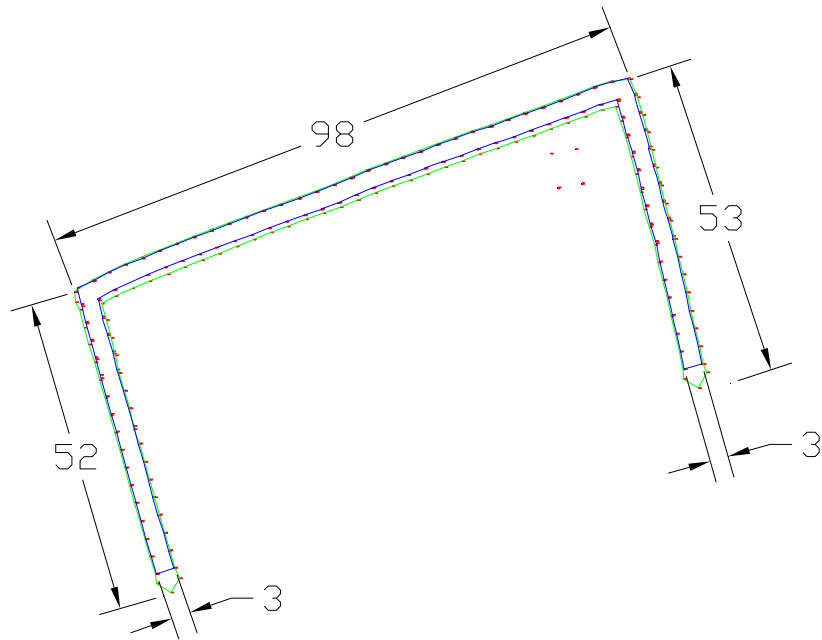

Figure 3-22. Hesco structural dimensions (ft)

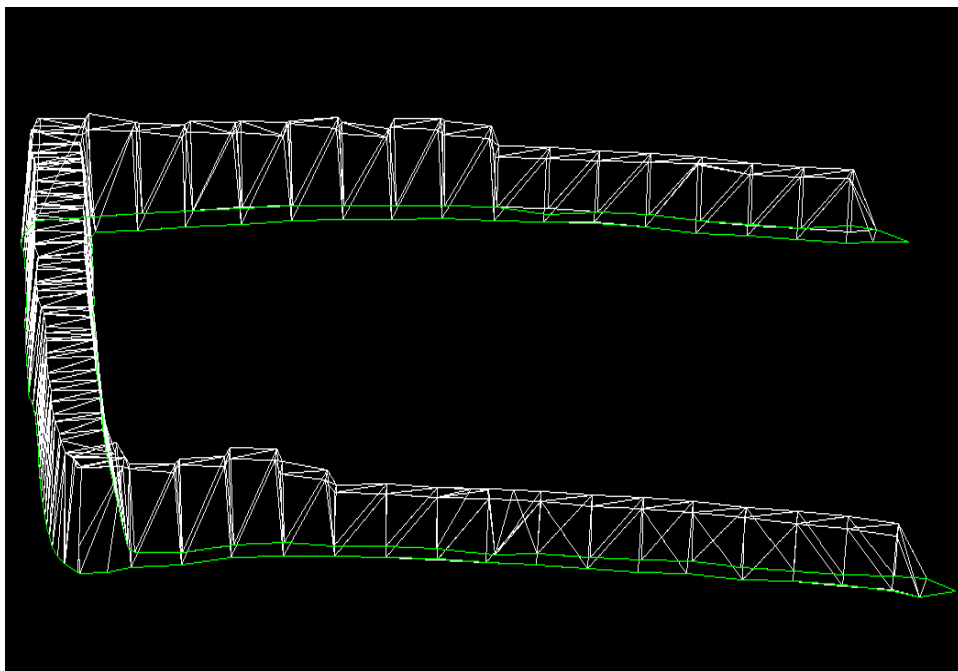

Figure 3-23. Hesco structure side view. Internal volume was 91 cu yd

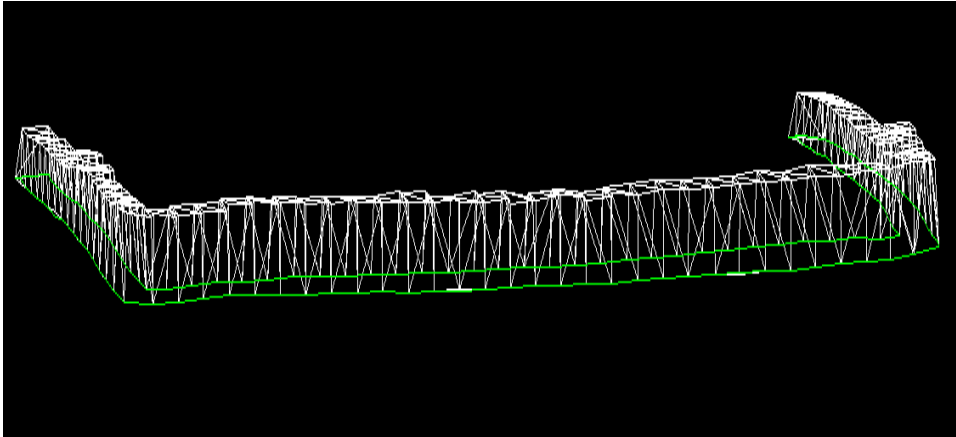

Figure 3-24. Hesco structure viewed from river

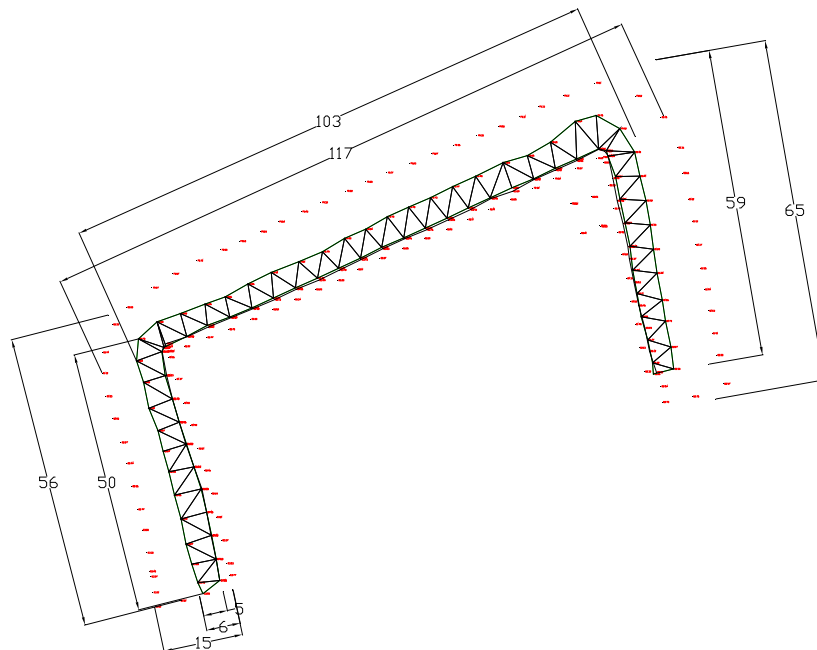

Figure 3-25. Portadam structure dimensions (ft)

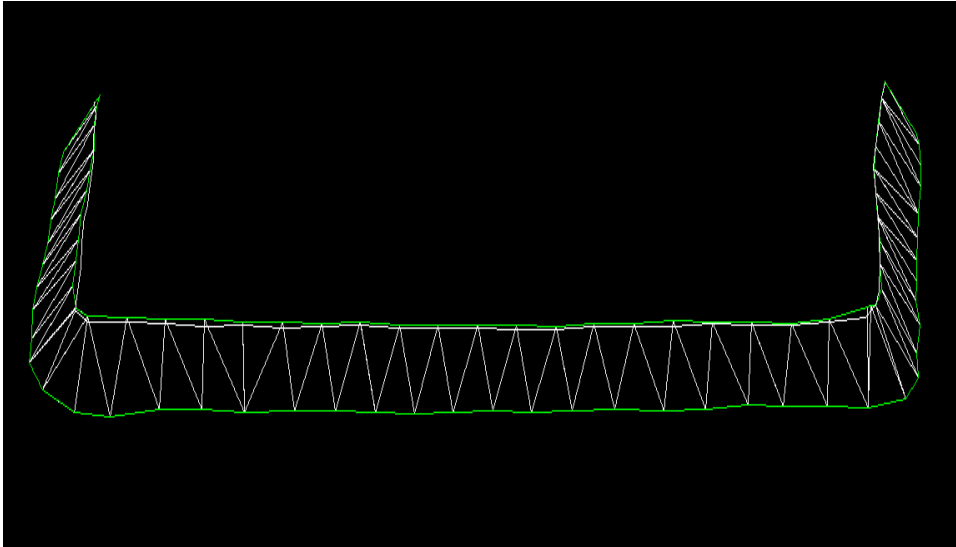

Figure 3-26. Portadam structure viewed from river side

Results

During the test period, total seepage rate was calculated for each structure using the timed filling of the concrete sumps as the river rose. The river elevation was logged on the outside of the structures. To ensure seepage rate comparability for each structure, the total wetted perimeter areas were normalized. A vertical section was cut through the middle of each leg along the center line. Area calculations were made by integrating between the bottom and top elevations of the center-line section. This area was the total potential wetted area for each structure. Since the structures were constructed at different elevations, the wetted perimeter area was calculated for each river elevation in 0.5-ft increments by drawing a line corresponding to the river elevation through the vertical center line. The area was calculated by integrating along the center-line section between the bottom elevation and the line representing the river elevation. Figures 3-27, 3-28, 3-29, and 3-30 represent these calculations. Figures 3-31 and 3-32 show the graphed seepage comparisons.

| RDFW Stage | RDFW Lift Area sq ft | RDFW Area sq ft | RDFW Q | RDFW Stage | RDFW Seepage gal/hr |
|------------|----------------------|-----------------|--------|------------|---------------------|
| | | 0 | 0 | | |
| 80.0 | 0.67 | 0.67 | 0 | 81.47 | 59.4 |
| 80.5 | 25.14 | 25.81 | 0 | 81.74 | 76.1 |
| 81.0 | 48.94 | 74.75 | 0 | 81.76 | 79.0 |
| 81.5 | 57.02 | 131.77 | 59 | 81.85 | 104.0 |
| 82.0 | 62.12 | 193.89 | 163 | 81.89 | 127.1 |
| 82.5 | 67.33 | 261.22 | 534 | 81.81 | 132.6 |
| 83.0 | 74.03 | 335.26 | 849 | 81.94 | 143.9 |
| 83.5 | 79.62 | 414.88 | 944 | 81.96 | 163.2 |
| 84.0 | | 494.50 | 1468 | 82.02 | 182.9 |

Figure 3-27. RDFW seepage data

| Sandbag Stage | Sandbag Lift Area sq ft | Sandbag Area sq ft | Sandbag Q | Sandbag Stage | Sandbag Seepage gal/hr |
|---------------|-------------------------|--------------------|-----------|---------------|------------------------|
| | | 0 | 0 | | |
| 78.3 | 42.08 | 42.08 | 0 | 80.40 | 110 |
| 78.8 | 65.93 | 108.01 | 0 | 80.49 | 155 |
| 79.3 | 70.11 | 178.11 | 0 | 80.58 | 247 |
| 79.8 | 75.11 | 253.22 | 0 | 80.64 | 276 |
| 80.3 | 79.07 | 332.29 | 110 | 80.80 | 380 |
| 80.8 | 85.18 | 417.47 | 380 | 80.86 | 427 |
| 81.3 | 87.73 | 505.20 | 922 | 80.90 | 473 |
| 81.8 | 91.71 | 596.91 | 3088 | 80.96 | 503 |
| 82.0 | | 687.91 | 4632 | 81.00 | 555 |

Figure 3-28. USACE sandbag seepage data

| Hesco Bastion Stage | Hesco Bastion Lift Area sq ft | Hesco Bastion Area sq ft | Hesco Bastion Q | Hesco Bastion Stage | Hesco Bastion Seepage gal/hr |
|---------------------|-------------------------------|--------------------------|-----------------|---------------------|------------------------------|
| | | 0 | 0 | | |
| 80.5 | 10.34 | 10.34 | 0 | 80.53 | 0 |
| 81.0 | 36.50 | 46.84 | 35 | 81.10 | 35 |
| 81.5 | 50.30 | 97.14 | 331 | 81.24 | 87 |
| 82.0 | 53.71 | 150.85 | 1325 | 81.50 | 315 |
| 82.5 | 58.33 | 209.18 | 2458 | 81.54 | 331 |
| 83.0 | 63.96 | 273.14 | 3400 | 81.68 | 534 |
| 83.5 | 74.65 | 347.79 | 4873 | 81.72 | 618 |
| 84.0 | 85.97 | 433.76 | 6751 | 81.87 | 988 |

Figure 3-29. Hesco Bastion seepage data

| Portadam Stage | Portadam Lift Area sq ft | Portadam Area sq ft | Portadam Q | Portadam Stage | Portadam Seepage gal/hr |
|----------------|--------------------------|---------------------|------------|----------------|-------------------------|
| | | 0 | 0 | | |
| 80.1 | 29.05 | 29.05 | 0 | 80.40 | 93 |
| 80.6 | 49.77 | 78.82 | 171 | 80.49 | 102 |
| 81.1 | 59.55 | 138.38 | 242 | 80.56 | 117 |
| 81.6 | 68.90 | 207.27 | 344 | 80.62 | 171 |
| 82.1 | 78.42 | 285.70 | 467 | 80.90 | 192 |
| 82.6 | 86.69 | 372.39 | 528 | 81.06 | 242 |
| 83.1 | 92.24 | 464.62 | 585 | 81.22 | 283 |
| 83.6 | 96.10 | 560.72 | 675 | 81.50 | 335 |
| 84.1 | 99.86 | 660.58 | 675 | 81.54 | 331 |

Figure 3-30. Portadam seepage data

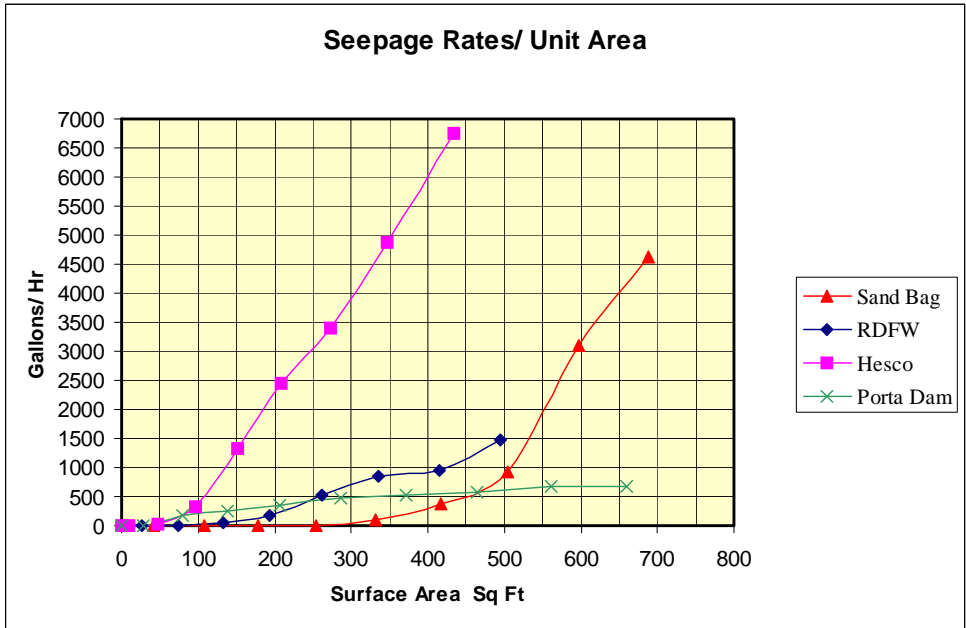

Figure 3-31. Seepage rate as a function of wetted perimeter area

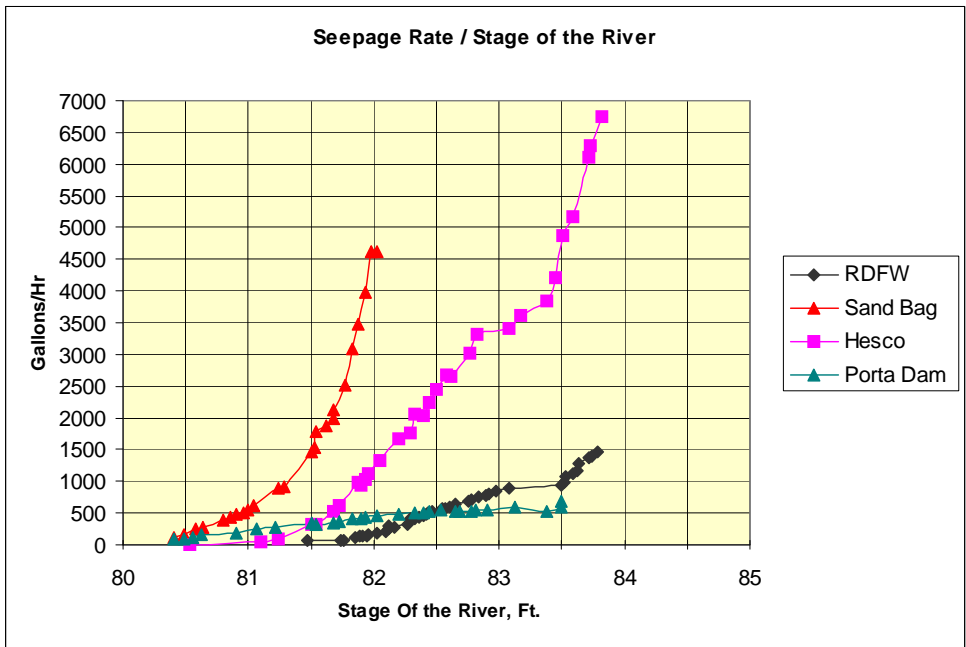

Figure 3-32. Seepage rate as a function of water elevation

Field Installation and Performance of Sandbag Barrier

Introduction

The Operations Division (Emergency Management Branch) and Construction Division, U.S. Army Engineer District, Vicksburg, directed the construction of the sandbag barrier at the field site. Construction was performed in accordance with the Vicksburg District's Flood Emergency Management Handbook. The construction process consisted of two operations: (a) filling the sandbags and (b) placement of sandbags in the construction of the structure. The two operations were conducted at different locations approximately one-fourth mile apart. After the sandbags were filled, they were loaded onto trucks and trailers and hauled over wet, muddy, and slippery terrain to the construction site.

Filling

Sandbags come in a variety of sizes, materials, and colors. For the Vicksburg Harbor field test, the sandbags used were the 14 × 26 in., anti-skid woven polypropylene with tie string. The bags have a tensile strength of 105 lb. For the field test, the bags were filled to an average weight of 50 lb.

The bags were delivered to the Vicksburg Harbor stacked flat on pallets and wrapped in plastic. The sandbags were bundled into bales, with the bales containing 1,000 bags. The bales were divided into 10 batches with 100 bags per batch. A total of 16 bales were delivered to the sandbag-filling site. Fill material used for the filling operation was clean, medium- to fine-grained sand. A total of 250 cu yd of sand was delivered to the site.

An automatic-speed sandbagger, Model ASB-3 (Hogan Manufacturing, Inc.) was rented to perform the filling operation (Figure 3-33). Filling sandbags began on the morning of 12 May 2004, in constant rain with mild temperatures. The filling crew included Vicksburg District volunteers and members of the District's Mat Sinking Unit. An official training session was not conducted, although none of the laborers had prior training or experience in filling sandbags. Training was acquired by filling and tying 450 sandbags needed for the Portadam structure. This operation took approximately one-half hr (6.4 man-hours). Once the bags were filled for the Portadam structure, filling of bags began for the sandbag structure.



Figure 3-33. Hogan automatic-speed sandbagger as delivered to field test site

The sandbags were filled in accordance with the Vicksburg District's Flood Emergency Management Handbook:

- a. Fill bags to approximately one-half to two-thirds capacity.
- b. Leave bags untied.

The filling of sandbags to build the structure took a total of 3-1/2 days. The sand bags were filled at a rate of 14 bags per minute, while the crew size varied from a maximum of 20 to as few as eight laborers. The inconsistency in the size of the crew was a result of the relocation of laborers to the construction site after filling the first group of bags, and volunteers returning to their regular duty jobs. Equipment required to fill the sandbags included the sandbagging machine, shovels, ladder, front-end loader, flatbed truck, and flatbed trailer. Approximately 13,400 bags were filled including the 450 for the Portadam structure. A total of 132 cu yd of sand was used during the filling operation. At the completion of the filling process, the laborers joined the construction crew to assist in the construction of the structure.

Field construction

Construction began the afternoon of 12 May 2004. Since none of the laborers had prior knowledge of placing sandbags, Vicksburg District Emergency Management personnel conducted a brief training session on the sandbag placement process. Training was in accordance with the District's Flood Emergency Management Handbook, which states:

- a. Overlap bags with closed end of bag placed on top of open end of the previous bag.
- b. Place rows so seams are staggered.
- c. Base width equal to three times the height.

Once the training session was completed and the first set of bags arrived (Figure 3-34), the workers began placing the first row along the desired alignment beginning with the east tieback section, followed by the riverward face and continuing to the west tieback section (Figures 3-35 and 3-36). In accordance with the construction protocol, about half of the site was graded to bare ground while the other half was left undisturbed with the natural grass and weeds. The second row of bags was staggered over the first row in accordance with the handbook (Figures 3-37a and b).

Ponding of rainwater on the inside of the structure delayed the beginning of construction on day 2 (Figure 3-38). The water was removed by pumping into the river (Figure 3-39). Once most of the water was removed, the area was bulldozed to make the site workable (Figure 3-40). The construction crew ranged from 14 to 23 laborers from both the District volunteers and the Mat Sinking Unit, and one equipment operator. Equipment used in constructing the 3-ft-high structure included a flatbed truck, trailer, and bulldozer. The construction crew took 27.5 hr (419.8 man-hours) to construct the 3-ft-high structure.

Once the structure was constructed to a height of 3 ft, work began on installing the required 1-ft raise (Figures 3-41 and 3-42). This raise was accomplished by placing several rows of sandbags, adding a height of 1 ft to the 3-ft structure (Figure 3-43). Figures 3-44a and 3-44b are photographs of the completed sandbag structure.



Figure 3-34. Unloading from flatbed truck



Figure 3-35. Laying first row of bags



Figure 3-36. Partially completed riverward face, first row



a. Looking along riverside face



b. Laborers passing sandbags

Figure 3-37. Placement of second row



Figure 3-38. Rain water collected inside structure



Figure 3-39. Water being pumped from structure



Figure 3-40. Area being backdragged to reduce mud



Figure 3-41. Measuring the height of structure



Figure 3-42. Completed 3-ft structure



Figure 3-43. Required 1-ft raise



a. Looking along riverside face



b. From protected side

Figure 3-44. Completed sandbag structure

The construction crew took 3.0 hr (33 man-hours) to construct the required raise. The total time to construct the sandbag structure was 30.5 hr (453.1 man-hours). The riverward face of the structure measured a length of 101 ft. The tieback sections measured 32 ft on the east side and 30 ft on the west.

Testing

The sandbag structure was constructed in May 2004 during a time when the river level was falling. However, by early June, the river had begun to rise and by the morning of 4 June, approximately 1 ft of water was standing against the structure. Figures 3-45 through 3-50 are a series of daily photos of the sandbag structure during the field testing. As the river continued to rise, the sandbag structure was exposed to higher water levels. The daily water levels against the structure are noted in each figure caption. These water levels were based on 8 a.m. readings for the Mississippi River at the Vicksburg gage. The testing of the sandbag structure ended when the structure overtopped on 7 June 2004.



Figure 3-45. 4 June 2004, 1.0 ft of water against structure



Figure 3-46. 5 June 2004, 2.3 ft of water against structure



Figure 3-47. 6 June 2004, 3.3 ft of water against structure



Figure 3-48. 7 June 2004, structure overtopping



Figure 3-49. 7 June 2004, seepage through structure



Figure 3-50. 7 June 2004, overtopped structure

During the field test, seepage was collected in a buried concrete tank (Figure 3-51a, b). Seepage rates were determined by computing the change in volume in the tank over a specific time. As the water level against the structure rose, the seepage rates increased. The first photo was taken on 5 June 2004 while the seepage rate was low. The second photo was taken on 6 June 2004 when the seepage rate had increased. Figure 3-52 is a photo of the seepage observed through the overlapping sandbags. Figure 3-53 shows the seepage water on the protected side of the structure. To compare seepage rates for all four structures, the wetted area for each structure for given water surface elevations was computed (Figure 3-54). The seepage rate for the sandbag structure exceeded 4,500 gal/hr when the structure had almost 700 sq ft of wetted area. The rate of seepage increased markedly when the wetted area reached 500 sq ft. As the seepage rate increased, an attempt was made to reduce the seepage by draping the east tieback with plastic sheeting and weighting the sheeting with sandbags (Figure 3-55a, b). The draping of the sheeting did not decrease the flow of water through the structure. The plastic sheeting was also draped over a low section of the riverward face to protect against concentrated flow (Figure 3-56). These were the only modifications made to the sandbag structure.



a. 5 June 2004



b. 6 June 2004

Figure 3-51. Sandbag seepage collection tank



Figure 3-52. Seepage through structure



Figure 3-53. Seepage on protected side

| Field Test Seepage Rates – Sandbag Structure | |
|--|-------------------------|
| Wetted Surface Area of Structure (sq ft) | Seepage Rate (gal / hr) |
| 100 | 0 |
| 200 | 0 |
| 300 | 50 |
| 400 | 300 |
| 500 | 800 |
| 600 | 3200 |

Figure 3-54. Seepage rates for field test sandbag structure



a. Prior to overtopping



b. Close-up

Figure 3-55. Attached plastic sheeting to east tieback of sandbag structure



Figure 3-56. Plastic sheeting over riverward face

Removal

Before removal of the sandbags began, photographs were taken to document the effects of the water on the structure after being submerged for over 30 days (Figures 3-57 through 3-60). The structure was subjected to hot, wet weather for 2 months. During this time, deterioration of the sandbags was noticeable. On the morning of 19 July, removal of the sandbag structure was initiated. The weather was hot and humid with a heat index near 105 deg F. The removal process required two equipment operators, front-end loader, and a bulldozer. The removal began with the bags on the east tieback being pushed into a pile by the bulldozer. The front-end loader then scooped up the bags and carried them to the disposal area. This was repeated until the entire structure was completely removed (Figures 3-61 through 3-66). Removal of the sandbag structure took a total of 2.6 hr (3.5 man-hours). Unlike the other three product structures, the sandbag structure was not removed to be reused. Therefore, a direct comparison of removal times for the other three product structures to the removal time for the sandbag structure cannot be made.



Figure 3-57. Structure after being submerged



Figure 3-58. Riverward face



Figure 3-59. East side of structure



Figure 3-60. East tieback section



Figure 3-61. Removal of east tieback section



Figure 3-62. Sandbags removed by front-end loader



Figure 3-63. Bulldozer piling up sandbags



Figure 3-64. Dozer and front-end loader



Figure 3-65. Disposal site



Figure 3-66. Structure completely removed

Reusability

The standard Corps practice during flood-fighting is to not attempt to reuse sandbags. The bags deteriorate rapidly during use and exposure to UV light. Emptying wet sand would be extremely time-consuming and cost-prohibitive. Therefore, sandbags were considered disposable in this project.

Summary

For the field-testing, various construction, removal, and performance parameters were evaluated. Table 3-1 provides a summary for the field testing of the sandbag structure.

Even if a product performs well, the flood-fighting community is not likely to use the product unless it is cost-effective. In order to make a fair comparison of costs, each product vendor was asked to submit the cost of constructing and removing 1,000 lft of their product, 3 ft high in Vicksburg, MS. This cost included the purchase of the product plus fill material, labor, and equipment based on Vicksburg rates. The cost of shipping the products were not provided. For this cost determination, sand fill delivered to the site was estimated at \$8 per cu yd. Labor rates were \$8/hr for laborers and \$12/hr for equipment operators. Table 3-2 provides a summary of the costs that were estimated for a sandbag structure. The costs contained in Table 3-2 were based on several assumptions. Those assumptions include a structure section that is 13 bags wide at the base and 2 bags wide at the crest, each sandbag adds 3 in. in height and 9 in. in length to the structure, the cost of each sandbag is \$0.25, the required volume of sand was increased by 20 percent to account for waste and spillage during filling, and the sandbag structure would be built by volunteer labor (no labor cost for construction).

| Table 3-1 Sandbag Structure Field Testing Summary | |
|--|---|
| Item | Sandbag Structure |
| ROW Used (ft) | 25 |
| Footprint Width (ft) | 12 |
| Structure Length (ft) Riverward Face East Tieback West Tieback | 101 32 30 |
| Ease of Construction Time (hr) Effort (man-hours) Manpower (no. laborers) Equipment | 30.5 453.1 Up to 20 (filling) Up to 27 (placing) Sandbagger Shovels Bulldozer Flat Bed Trailer |
| Fill (cu yd) | 132 |
| Durability | The sandbag structure stayed in the field for 2 months and was subjected to hot, wet weather. The bags deteriorated badly. The Vicksburg District EM Office determined that sandbags did not meet specs (not adequate weave count). |
| Varying Terrain | The field test site was relatively flat with a mild slope from the protected side of the sandbag structure to the riverward side. |
| Ease of Removal Time (hr) Effort (man-hours) Manpower (no. men) Equipment | 2.6 (disposed – not removed to be reused) 3.5 2 Front-end Loader Bulldozer |
| Seepage (gal/hr) For 100 sq ft Wetted Area For 200 sq ft Wetted Area For 300 sq ft Wetted Area For 400 sq ft Wetted Area For 500 sq ft Wetted Area For 600 sq ft Wetted Area | 0 0 50 300 800 3200 |
| Repairs | All Minor – Structural Integrity Not Threatened Added Plastic Sheeting Immediately Prior to Overtopping to Reduce Seepage |
| Reusability (percent) | 0 – All Disposed |

| Table 3-2 Costs for Sandbag Structure | |
|--|--|
| Item | Sandbag Structure |
| Product | \$0.25 per bag for 120,000 bags = \$30,000 |
| Shipping | No \$ estimated |
| Installation Laborers Operators Equipment Fill | Built by volunteer labor = \$0 1 man for 40 hours = \$480 Sandbagger 1 loader for 5 days = \$1,650 800 cu yd = \$6,400 |
| Removal Laborers Operators Equipment | None required 3 men for 8 hr = \$288 2 loaders for 1 day = \$650 2 dump trucks for 1 day = \$650 |
| Training by vendor for installation and removal | By volunteers |
| Technical support during installation and removal | By volunteers |

Based on the field testing, strengths and weaknesses of each product were observed. The strengths of the sandbag structure include low cost primarily because sandbag structures in a real-world flood are generally constructed by volunteer and/or prison labor. Because of the small size of the individual bags, sandbags conform well to varying terrain. For the field tests, the sandbag structure performed well with low seepage rates. Also, sandbag structures can be raised if needed by simply placing additional sandbags. The weaknesses of a sandbag structure are that they are labor intensive and time-consuming to construct. Also, sandbags are not reusable. All the sandbags used in the field-testing were disposed. For the field tests, the sandbags structure was constructed during the middle of May 2004 and removed during the middle of July 2004. Therefore, the structure was exposed to the elements for 2 months. During that time, the sandbags began to deteriorate. In fact, at the time of removal, walking on the bags would easily tear them and if you picked one up by the open end, the weight of the sand in the bag would tear the closed end out of the bag. The Vicksburg District Emergency Management personnel have determined that the bags used for the field test did not meet their sandbag specifications for weave count.

Field Installation and Performance of Hesco Bastion Concertainer

Introduction

The Hesco Bastion Concertainers are manufactured in the United States by Hesco Bastion – USA of Hammond, LA. The concertainers are described by Hesco as “a prefabricated, multi-cellular system, made of galvanized steel Weldmesh and lined with non-woven polypropylene geotextile.” In common terms, the concertainers are granular-filled, geotextile-lined wire baskets. The Hesco Bastion Concertainers have several uses but primarily have been used since the early 1990s (Persian Gulf War) as military force protection.

The Hesco Bastion Concertainers are manufactured in a wide range of sizes. For the Vicksburg Harbor field test, units 3-ft wide by 3-ft high by 12-ft long were used to provide the required 3-ft flood protection. For the required 1-ft raise, units 3-ft wide by 2-ft high by 12-ft long were placed on top of the 3-ft high base row units. Since the concertainers are a multicellular system, each unit contained four individual 3-ft-long cells. The units were pinned together to form a u-shaped structure with a riverward face of 98 ft with tieback sections of 48 ft.

Field construction

The concertainer units as delivered to the Vicksburg Harbor were stacked flat on wood pallets and wrapped with plastic (Figure 3-67). Prior to installation, concertainer pallets were prepositioned adjacent to the construction site. The construction crew included a Hesco Bastion representative, four government-furnished laborers, and two government-furnished equipment operators. The government also furnished two tracked Bobcat front-end loaders. None of the government laborers or operators had any prior knowledge of the Hesco Bastion product.

Construction of the Hesco Bastion Concertainer structure began on the morning of 12 May 2004, in constant rain and mild temperatures. Figure 3-68 is a photograph of the Hesco Bastion site prior to construction. Because the Government laborers and operators were unfamiliar with the product, the Hesco Bastion representative conducted a 23-min training session on the installation process (Figure 3-69). At the completion of the training session, the workers began placing the base row units along the desired alignment (Figure 3-70). In accordance with the construction protocol, about half of the site was graded to bare ground while the other half was left undisturbed with the natural grass and weeds (Figure 3-71). The units were installed according to Hesco instructions as follows.



Figure 3-67. Hesco Bastion as delivered to Vicksburg



Figure 3-68. Hesco Bastion field site prior to construction



Figure 3-69. Hesco Bastion training session



Figure 3-70. Installation of base row units



Figure 3-71. Structure constructed on graded ground and grass/weeds

Units were pinned together to form a continuous barrier by inserting joint pins through the coils of adjacent units (Figure 3-72). The units also were connected with zip ties placed along the top of adjacent unit end panels. Riverward face units of the structure were placed first, followed by the tieback sections (Figure 3-73). Each unit has a 5-in. liner flap on the bottom. Care was taken to ensure that these flaps were turned to the inside of each unit prior to filling, so that the weight of the sand on the flaps secured the units in place. Once the base row units were placed, the units were filled with sand to within approximately 5 in. of the top (Figure 3-74). The units were not completely filled because the bottom flaps on the top row are turned down and buried into the sand in the base row units. The sand had previously been stockpiled adjacent to the Hesco Bastion site and was placed in the units by two tracked front-end loaders. The laborers spread the sand within the units with shovels and manually compacted the sand by walking on it. Sand was placed in the concertainers primarily from the protected side of the structure. However, due to the location of the seepage-collection tank in the northeast corner of the structure, the sand in the vicinity of the tank was placed from the riverside.



Figure 3-72. Installation of joint pins



Figure 3-73. Construction of base row tieback section



Figure 3-74. Filling base row with sand



Once the base row was filled, the required 3-ft-high structure was finished. The construction crew of one Hesco Bastion representative, four government laborers, and two government equipment operators took 5.1 hr and 34.7 man-hours to construct the 3-ft-high structure. The only equipment used to construct the base row was shovels and the two tracked Bobcats.

Once the required 3-ft-high structure was finished, work began on installing the 1-ft raise required by the construction protocol. Hesco Bastion accomplished the raise by adding a second row of units on top of the base row (Figure 3-75). The units for the second row were 3 ft wide by 2 ft high by 12 ft long. Due to the natural ground slope at the Hesco Bastion site, the top row tieback sections were only 27.6 ft and 15.25 ft long.

The construction crew installed two of the top row units before work ended on the afternoon of 12 May. Work on the required raise resumed on the morning of 13 May. The weather that morning was sunny and humid. Since the tieback sections were placed on sloping ground, the top row was only needed on the riverward face and portions of the

tieback sections. The top units were unfolded and placed directly on top of the base row units. Joint pins were added to the top row and these units were zip-tied together at the top of the end panels of adjacent units. The top row and base row units were also zip-tied together. Once the top-row units were secured, sand was placed in the units. Initially, the sand was placed in the top row units from the protected side except for the northeast corner, to avoid the seepage collection tank.

During the time that the units were being filled, the ground around the structure was extremely muddy and slick. Because the riverward front of the structure was constructed on sloping ground, the Hesco Bastion representative was concerned that during filling, the Bobcats would slide into and damage the structure.



Figure 3-75. Installing top row units (required raise)

Therefore, he requested and was granted permission to fill portions of the riverward front from the riverside (Figure 3-76). Since the top row units were 2 ft high and the required raise was only 1 ft, the top row units were not completely filled. The amount of fill varied in the top row units but averaged about 18 in. (Figure 3-77).



Figure 3-76. Filling top row units with sand



Figure 3-77. Sand fill in top row units

The construction crew of one Hesco Bastion representative, four government laborers, and two government equipment operators took 3.8 hr and 22.8 man-hours to construct the required raise. The total time to construct the Hesco Bastion structure was 8.9 hr or 57.5 man-hours. Construction of the Hesco Bastion structure was completed

just prior to noon on 13 May. The equipment used to construct the top row was the same shovels and the two tracked Bobcats that were used to construct the base row.

The Hesco Bastion Concertainer units used at the Vicksburg Harbor test site were 3 ft wide when empty. However, as sand was placed in the units, the units began to expand. The cells within the units ranged from 40 to 48 in. wide when the structure was finished. Therefore, the units used for the field test have a footprint of 4 ft. The Hesco Bastion structure required 91 cu yd of sand fill. Also, Hesco Bastion was allowed a 25-ft right of way to construct their structure. Because the structure was filled from the side with tracked Bobcats, the entire 25-ft right of way was used. Figures 3-78 and 3-79 are photographs of the completed Hesco Bastion structure. Once the construction was completed, the Hesco Bastion representative signed a certification that the structure was constructed according to his onsite directions and in accordance with Hesco Bastion's installation specifications.



Figure 3-78. Riverward face of completed structure



Figure 3-79. Completed structure from protected side

Testing

The Hesco Bastion Concertainer structure was constructed during a time when the river levels were falling. However, by early June, as predicted, the river had begun to rise and by the morning of 5 June approximately 0.3 ft of water was standing against the structure. Figures 3-80 through 3-87 show the Hesco Bastion structure during field testing. As the river continued to rise, the Hesco Bastion structure was subjected to higher water levels. The daily water levels against the structure are given in the figure captions. These water levels were based on 8 a.m. readings for the Mississippi River at the Vicksburg gage. The testing of the Hesco Bastion structure ended on 11 June 2004. The river never rose high enough to overtop the top row units. However, sand in five of the riverside top row cells was at the level to provide exactly 4 ft of protection. On 11 June, the river level rose high enough to overtop the sand in those five cells. The decision was made in collaboration with the Hesco Bastion representative to stop the tests at that point even though the pump capacity had not been exceeded.



Figure 3-80. 4 June 2004, no water against structure



Figure 3-81. 5 June 2004, 0.3 ft of water against structure



Figure 3-82. 6 June 2004, 1.3 ft of water against structure



Figure 3-83. 7 June 2004, 2.1 ft of water against structure



Figure 3-84. 8 June 2004, 2.7 ft of water against structure



Figure 3-85. 9 June 2004, 3.1 ft of water against structure



Figure 3-86. 10 June 2004, 3.5 ft of water against structure



Figure 3-87. 11 June 2004, 4.0 ft of water against structure

During the field test, seepage was collected in a buried concrete tank located on the protected side of the structure. Seepage rates were determined by computing the change in volume in the tank over a specific time. As the water level rose against the structure, seepage rates increased. Figure 3-88 shows two photographs of the Hesco Bastion structure seepage tank. The first photograph was taken on 6 June 2004 while the seepage rate was low. The second photograph was taken on 10 June 2004 when the seepage rate had increased noticeably. Figure 3-89 is a photograph of the seepage observed through the joint between adjacent units. Figure 3-90 shows the seepage water on the protected side of the structure. To determine seepage rates, the wetted area for each structure for a given water surface elevation was computed. Table 3-3 provides the seepage rates for the Hesco structure. The seepage rates for the Hesco Bastion structure were high. The seepage rates were high enough that the Hesco Bastion representative attempted repairs to try to reduce through seepage.



a. 6 June 2004



b. 10 June 2004

Figure 3-88. Hesco Bastion seepage collection tank



Figure 3-89. Seepage through joints



Figure 3-90. Seepage on protected side

| Table 3-3 FieldTest Seepage Rates - Hesco Bastion | |
|--|----------------------------------|
| Wetted Area of Structure (sq ft) | Seepage Rate (gal/hr) |
| 100 | 300 |
| 200 | 2,300 |
| 300 | 3,900 |
| 400 | 6,000 |

The first repair was made on 8 June and included the addition of plastic sheeting to the riverward face of the structure (Figure 3-91). This repair was made with 2.5 to 3.0 ft of water against the structure. The plastic sheeting was rolled out and attached to the top of the top layer units with zip-ties. The sheeting was weighted and held against the bottom of the base row units with sandbags. At the time that the repair was made, the seepage rate was approximately 4,000 gal/hr. The repair temporarily reduced seepage, with the rate falling to approximately 3,000 gal/hr. The repair was made on the afternoon of 8 June. By the morning of 9 June, the seepage rate had risen to approximately 4,300 gal/hr with only a few tenths of a foot rise in the river level.



Figure 3-91. Attaching plastic sheeting to riverward face of Hesco Bastion structure

The second repair was made on 9 June. This repair consisted of attaching half sections of 4-in. PVC sewer pipe across the unit joints with zip ties. Bentonite slurry, dry powder, and pellets along with sand was poured into the top of the pipes and packed down (Figure 3-92). Hesco representatives expected the bentonite in the pipes to swell and seal the joints. This repair was made with just over 3 ft of water against the structure. After the pipes were installed, the seepage rate continued to increase. Once the river levels dropped after the testing was completed, the Hesco Bastion structure was visually inspected. Apparently, an excess of bentonite was packed into the pipes. As the bentonite swelled, the pipes were pushed away from the joints thus providing no sealing of the joints.

Removal

Removal of the Hesco Bastion structure was initiated on the morning of 14 July. The weather was hot and humid with a heat index near 105 deg F. Due to the extreme heat, the work crew took frequent breaks. Only the time that the crew was physically working to remove the structure was included in the removal time (the clock stopped during breaks). The removal began with a three-man Hesco Bastion crew removing the top row layer. Hesco Bastion requested and was allowed to remove the top row layer since the government-furnished crew was unavailable at that time.

The first action in the removal process was removing the joint connection pins between the units and the center connection pins within each unit. To remove the center connection pins from the unit ends, the liner material had to be cut to expose the pins. Prior to reusing the units, this liner material has to be replaced. The removal of the center connection pins is required to break each unit into a front face half and a back face half. The pins were removed by two men using a pin removal bar and a chain (Figure 3-93). Once the pins were removed, the zip-ties between the top row units and the bottom row units were cut (Figure 3-94). This allowed the work crew to lift and pull the half units from the sand (Figure 3-95).

Figure 3-96 is a photograph of the riverward face of the structure after the outer half unit sections were removed from the top row. Once the top row units were removed, the sand from those units was scraped off of the base row units with a front-end loader



a. Attaching pipe to joints



b. Bentonite slurry



c. Bentonite pellets



d. Pipe with bentonite



e. Packing bentonite into pipes



f. Bentonite-filled pipes after water receded

Figure 3-92. Attempt to reduce seepage using bentonite



Figure 3-93. Removing center connection pins



Figure 3-94. Removing zip ties



Figure 3-95. Removal of top row half units



Figure 3-96. Riverward face of structure

(Figure 3-97). This sand was then removed from around the base row units so that they could be removed (Figure 3-98). The base row units were removed by a crew of two Hesco Bastion representatives and four government laborers plus a government equipment operator. The same process was used to remove the base row units that were used to remove the top row units. Most of the base row half units were physically lifted and pulled from the sand by hand (Figure 3-99). However, when the joint-connection pins were pulled from the riverward face of the base row, two half sections were pushed over by the weight of the sand because these units were on sloping ground. The removal crew used the front-end loader and four chains to remove these half sections (Figure 3-100). They also used the front-end loader to pull some of the joint-connection and center-connection pins from the base row units (Figure 3-101).

Once the units were removed, the front-end loader was used to remove the sand to a disposal site on the extreme west end of the Vicksburg Harbor testing site. The average haul distance from the Hesco Bastion structure was approximately 550 ft. By the end of the day (14 July), most of the structure had been removed. The remainder of the structure was removed during the early morning on 15 July. Since the weather that day was extremely hot and humid, work began at 6:10 a.m. The entire structure including the sand fill was removed from the site by late morning. The removal of the Hesco Bastion structure and sand fill took a total of 8.7 hr or 36.3 man-hours. The equipment used to remove

the Hesco Bastion structure included shovels, a joint-pin-removal bar and chain, and a front-end loader. Once the structure was removed, the Hesco Bastion representative signed a certification that the structure was removed according to his onsite directions and in accordance with Hesco Bastion's removal specifications.



Figure 3-97. Removal of top row sand



Figure 3-98. Removal of sand from around base row units



Figure 3-99. Removal of base row half units



Figure 3-100. Removal of half units with front-end loader



Figure 3-101. Removal of joint-connection pins with front-end loader

Reusability

Once removed, the Hesco Bastion units were inspected for damage, folded, and placed on pallets for transport offsite. All of the Hesco Bastion units used for field testing were folded and strapped to four pallets (Figure 3-102). The removed units were stacked to a height of 36 in. on three pallets and to 40 in. on the fourth pallet. All four pallets were loaded onto a standard 16-ft trailer (Figure 3-103) for transport back to the Hesco Bastion plant.



Figure 3-102. Removed units on pallet (pallets 48 × 40 in.)



Figure 3-103. Removed units on trailer

None of the top row units (2 ft × 3 ft × 12 ft) sustained any damage. Some limited damage was noted to base-row units. Each of the Hesco Bastion base row units was made up of eight side panels (36 in. × 36 in.), 10 cross panels (36 ft × 18 in.) and 20 coils. Table 3-4 provides an inventory of the damage.

| Table 3-4 Hesco Bastion Damage | | | | | | | |
|---|------------------|--------------------|----------------|---------------------|----------------|--------------|----------------|
| Units | No. Units | Side Panels | | Cross Panels | | Coils | |
| | | Used | Damaged | Used | Damaged | Used | Damaged |
| 3 ft x 3 ft x12 ft | 16 | 128 | 9 | 160 | 10 | 320 | 6 |
| 2 ft x 3 ft x 12 ft | 11 | 88 | 0 | 110 | 0 | 220 | 0 |

Table 3-4 shows that the Hesco Bastion units received limited damage with over 95 percent of the side panels, over 96 percent of the cross panels, and over 98 percent of the coils reusable. Damaged or cut pieces can be replaced, making the unit reusable. All damage to the Hesco Bastion units occurred during removal. The damage can be directly attributed to the use of heavy machinery. Once the top row units were removed, a front-end loader was used to scrape the remaining sand from these units off of the bottom row units, which damaged some panels and coils. Also, the front-end loader and chains were used to hoist some of the bottom row sections that were heavily weighted with sand. This lifting damaged some panels to which the chains were attached. Figure 3-104 provides examples of the damage that the units experienced during the removal process.



Figure 3-104. Units damaged during removal process

The units can be cleaned by washing the sand, mud, and debris off the units with a garden hose. If the units are washed, the liner should be completely dry before folding and storing. If the soil on the units is dry, the soil can be swept off the liner with a broom. In this project, the units were not cleaned at the field site, but were packed for shipping immediately after disassembly.

Summary

For the field testing, various construction, removal, and performance parameters were evaluated. Table 3-5 provides a summary for the field testing of the Hesco Bastion Concertainer structure.

| Table 3-5 Hesco Bastion Field Testing Summary | |
|--|---|
| Item | Hesco Bastion |
| ROW Used (ft) | 25 |
| Footprint Width (ft) | 4 (includes bulge in 3-ft wide units) |
| Structure Length (ft) Riverward Face East Tieback West Tieback | 98 48 48 |
| Ease of Construction Time (hr) Effort (man-hours) Manpower (no. men) Equipment | 8.9 57.5 7 Shovels 2 Bobcat Loaders |
| Fill (cu yd) | 91 |
| Durability | The Hesco Bastion structure stayed in the field for 2 months and was subjected to hot, wet weather. The structure showed no signs of deterioration. |
| Varying Terrain | The field test site was relatively flat with a mild slope from the protected side of the Hesco Bastion structure to the riverward side. |
| Ease of Removal Time (hr) Effort (man-hours) Manpower (no. men) Equipment | 8.7 36.3 6 Shovels Pin Removal Bar Front End Loader Forklift |
| Seepage (gal / hr) For 100 sq ft Wetted Area For 200 sq ft Wetted Area For 300 sq ft Wetted Area For 400 sq ft Wetted Area | 300 2,300 3,900 6,000 |
| Repairs | All Minor – Structural Integrity Not Threatened Attempted to Seal Joints with Plastic Sheeting and Bentonite |
| Reusability (percent) | > 95 |

Even if a product performs well, the flood-fighting community is not likely to use the product unless it is cost-effective. In order to make a fair comparison of costs, each

product vendor was asked to submit the cost of constructing and removing 1,000 lft of their product, 3 ft high in Vicksburg, MS. This cost included the purchase of the product plus fill material, labor, and equipment based on Vicksburg rates. The cost for shipping the products were not provided. For this cost determination, sand fill delivered to the site was estimated at \$8 per cu yd. Labor rates were \$8/hr for laborers and \$12/hr for equipment operators. Table 3-6 provides a summary of the costs furnished by Hesco Bastion. The Hesco Bastion Concertainers are reusable. However, Hesco Bastion does not provide a guarantee that would provide for no cost replacement of damaged units.

| Table 3-6 Costs for Hesco Bastion Concertainer | |
|--|---|
| Item | Hesco Bastion Provided Cost |
| Product | 67 3'x3'x15' units at \$394/unit = \$26,398. |
| Shipping | No \$ provided |
| Installation Laborers Operators Equipment Fill | 6 men for 20 hr = \$960 2 men for 20 hr = \$480 2 loaders for 2 days = \$1,300 425 cu yd = \$3,400 |
| Removal Laborers Operators Equipment | 6 men for 20 hr = \$960 2 men for 20 hr = \$480 2 loaders for 2 days = \$1,300 |
| Training by vendor for installation and removal | No charge for initial installation |
| Technical support during installation and removal | No charge for initial installation |

Based on the field testing, strengths and weaknesses of each product were observed. Hesco Bastion's strengths include ease of both construction and removal for time and manpower. The field testing showed that a Hesco Bastion structure can be constructed quickly and with a limited labor force as compared to a comparable sandbag structure. Another of Hesco Bastion's strengths is low product cost. The cost for a Hesco Bastion concertainer structure is comparable to the cost of a sandbag structure. That comparison includes labor to construct a Hesco Bastion structure and only limited labor for a sandbag structure since during real-world flood events, sandbags are typically constructed by volunteer and/or prison labor. However, with all the products tested, the cost of the product is the large majority of the total cost. The installation cost including labor, equipment, and materials is minor as compared to the purchase price of the products. A Hesco Bastion structure can be raised if required by placing additional units to the top of the structure. If the required raise is more than 1-1/2 to 2 ft, then stability becomes an issue. In that instance, the structure should be raised by first placing a second row of units along the original base row to increase the width of the structure. A second row can be placed in a pyramid shape on top of the base rows. Hesco Bastion units proved in the field tests to be reusable. Inspection of Hesco Bastion units subsequent to completion of the removal process showed that over 95 percent of the unit pieces were reusable. A small number of panels and coils were damaged during the removal process. However, these pieces are easily replaced. The observed weaknesses of the Hesco Bastion product include the need for significant construction right of way. Hesco Bastion structures are granular filled. At present, the fill material is placed in the units with a loader that works perpendicular to the structure. This operation results in additional right of way needed to

fill the units. The Hesco Bastion structure tested in the field had high seepage rates relative to the other structures. Since completion of the testing, Hesco Bastion has evaluated their seepage rates. Their evaluation concluded that they installed the concertainer units incorrectly. Their standard installation protocol includes removing the permeable liner from the ends of adjoining units so that the sand fill can flow freely between the adjacent cells. For the field testing, the liner was not removed. If installed correctly, the seepage rates for a Hesco Bastion structure should be significantly reduced.

Field Installation and Performance of Rapid Deployment Flood Wall (RDFW)

Introduction

Rapid Deployment Flood Wall (RDFW) units are manufactured in the United States by Geocell Systems, Inc. The RDFW is described by Geocell as “a modular, collapsible plastic grid.” In common terms, the units are plastic grids filled with granular material, interlocked and stacked together to form a wall.

Field construction

One RDFW unit is 41.5 in. and holds approximately 0.3 cu yd of fill material. Each unit contains 35 individual cells. For the Vicksburg Harbor field test, the units were connected end to end by the interlocking tabs. A structure high enough to hold back 3 ft of water was accomplished by stacking five units (40 in.) to form the wall. In accordance with the construction protocol, a raise of the structure to hold back 4 ft of water was required. RDFW accomplished the raise by adding a single row of units (8 in. high) on top of the initial 40-in.-high structure.

The RDFW units were delivered to the Vicksburg Harbor in crates. Six crates were delivered containing 100 units each. Figure 3-105 shows the RDFW units as delivered to the field testing site. Prior to installation, the crates were prepositioned adjacent to the construction site. The construction crew included a Geocell representative, four government-furnished laborers, and two government-furnished equipment operators. The government also furnished two tracked Bobcat front-end loaders. None of the government laborers or operators had any prior experience with the RDFW product. Construction of the RDFW structure began on the morning of 13 May 2004.

During site preparation, the RDFW testing area was left partly undisturbed (grass and weeds remaining) and partly graded to bare ground. Because of the rainy weather conditions on the day of construction, the testing area was back-dragged with a Bobcat front-end loader to bring the moisture to the surface to assure direct contact with the ground and proper seating of the product (Figure 3-106).



Figure 3-105. RDFW as delivered to Vicksburg



Figure 3-106. RDFW site back-dragged prior to construction

Because the government employees were unfamiliar with the product, the RDFW representative conducted a 4-min training session on the installation process (Figure 3-107). Once the training session was completed, the workers began placing the base layer units along the desired alignment (Figure 3-108a-b). The units were connected together by interlocking the end tabs of the adjacent unit (Figure 3-108c).



Figure 3-107. RDFW training session



Figure 3-108a. Unpacking of RDFW units



Figure 3-108b. Installation of RDFW base row



Figure 3-108c. Interlocking of RDFW units

The riverward face units of the structure and the tieback sections were placed simultaneously row by row (Figures 3-109 and 3-110). Since the tieback sections were placed on sloping ground, the row heights were stair-stepped along the section



Figure 3-109. Installation of tieback section



Figure 3-110. Installation of riverward face and tieback section

(Figure 3-111). Once the height of the structure reached 40 in., the units were filled with sand. The sand had previously been stockpiled adjacent to the RDFW site and was placed in the units by two tracked Bobcat front-end loaders. The laborers spread the sand within the units with shovels. The sand was primarily filled from the protected side of the structure. However, due to the prepositioning of the seepage-collection tank in the northeast corner, the sand in the vicinity of the tank was placed from the riverside of the structure. The units were filled beginning with the west tieback section (Figure 3-112), followed by the riverward face and finally the east tieback section (Figure 3-113).



Figure 3-111. Stair-stepped tieback section



Figure 3-112. Filling of west tieback section units

Once the structure was filled with sand, the required structure that would hold back 3 ft of water was finished. Since the RDFW units are 8 in. high, the structure consisted of five rows of units. That resulted in a structure that was 40 in. high. The construction crew of one RDFW representative, four government laborers, and two government equipment operators took 6.1 hr (39.4 man-hours) to construct the 40-in.-high structure.

Once the required structure to hold back 3 ft of water was finished, work began on installing the required raise to hold back 4 ft of water. The raise was accomplished by adding a single row of units on top of the 40-in.-high structure (Figure 3-115). The top row units were unfolded and placed directly on top of the base row units. The top units



Figure 3-113. Filling of riverward face and east tieback section units



Figure 3-114. Installation of top row units (required raise)

were then connected together in the same manner as the previously placed units. Once the top row units were secured, sand fill was placed in these units. As with the previously filled units, the sand was primarily placed in the top row units from the protected side except for the northeast corner in order to avoid the seepage collection tank. During the time that the units were being filled, the ground around the structure was extremely muddy and slick.

The construction crew of one RDFW representative, four government laborers, and two government equipment operators took 1.4 hr (9.0 man-hr) to construct the required raise. The total time to construct the RDFW structure was 7.5 hr (48.4 man-hr). The amount of sand fill used for the construction of the RDFW structure was approximately 85 cu yd. Figures 3-115, 3-116, and 3-117 show the finished RDFW structure. In accordance with the construction protocol, the Geocell Systems' representative signed a certification that the structure was constructed in accordance with his onsite directions and according to Geocell Systems' installation specifications.



Figure 3-115. Sand fill in completed structure



Figure 3-116. Riverward face of completed structure



Figure 3-117. Completed RDFW structure

Testing

Testing of the RDFW structure began on 5 June 2004. The beginning of the test was defined when the river rose to a level at which the water was touching the structure. On that date, less than 1 ft of water was against the structure. Figures 3-118 and 3-119 show water levels the day before and the day testing began. Seepage rates were determined by computing the change in volume in the collection tank over a specified time.



Figure 3-118. River level the day before testing began, 4 June 2004



Figure 3-119. River level at beginning of testing process

The structure was continuously monitored for structural damage, material loss, and structure failure or fatigue. The seepage rate was calculated a minimum of four times per day. Measurable seepage began 6 June 2004. Figures 3-120 and 3-121 show the seepage water flowing within the structure and collecting in the sump tank.



Figure 3-120. Seepage behind RDFW structure



Figure 3-121. Seepage collection in sump tank

During testing, no major repairs were required to the RDFW structure. One minor repair performed by the RDFW representative was to refill units where the sand was washed out where the units had not been properly placed during construction (Figures 3-122 and 3-123). This repair was accomplished by adding sand to the washed-out compartments of the units (Figures 3-124 and 3-125). The repairs were completed by one RDFW representative, four government laborers, and one government equipment operator using shovels and a backhoe. Also during testing, a small sand boil (or pin boil) developed in the northeast corner of the structure near the sump tank. The boil was contained by placing a RDFW half unit over the boil (Figures 3-126 and 3-127).



Figure 3-122. Fill material washed out of units (view down from top)



Figure 3-123. Shifting of units (view down front edge from top)



Figure 3-124. Replacing sand washed out or lost from shifted units



Figure 3-125. Trackhoe replacing sand field



Figure 3-126. Using RDFW unit to contain sand boil



Figure 3-127. Contained sand boil

Testing ended when the structure was overtopped by water flowing freely over the structure. Overtopping occurred on 11 June 2004 with the water level on the structure at 4.2 ft. Figures 3-128 and 3-129 show the RDFW structure just before and during overtopping on 11 June 2004, 6 days after the beginning of the testing process. Final overtopping is shown in Figure 3-130.



Figure 3-128. RDFW structure before overtopping



Figure 3-129. Overtopping of RDFW structure



Figure 3-130. Final overtopping of RDFW structure

| Table 3-7 Field Test Seepage Rates - RDFW | |
|--|-----------------------------------|
| Wetted Surface Area of Structure, (sq ft) | Seepage Rate (gal/ hr) |
| 100 | 50 |
| 200 | 200 |
| 300 | 700 |
| 400 | 900 |
| 500 | 1500 |

Removal

Removal of the Geocell-RDFW structure began on 12 July 2004 and was performed intermittently over 4 days, during which several methods were used to extract the sand fill from the RDFW units. The first technique involved attempting to remove the sand

with hand held vacuum devices. These devices were powered by a rented air compressor (Figure 3-131). The initial attempt included the removal of the sand fill in its natural consolidated condition (Figure 3-132). After several attempts, water was pumped into the structure units to saturate the sand fill. The hand held devices were used to remove the saturated fill (Figure 3-133). For both of these conditions, the vacuum devices repeatedly clogged with sand. The use of the hand held vacuum devices provided ineffective and was abandoned. The RDFW representatives then tried blowing the consolidated sand out of the structure units with compressed air, tried washing the sand out with water provided through a pump and fire hose, and tried using the hose and compressed air at the same time (Figure 3-134). The sand was well compacted and all three of these methods were judged ineffective and abandoned. The RDFW representatives then decided to upgrade the equipment used for removal, and rented a vacuum truck (Figure 3-135). During the delays caused by changing methods and renting equipment, government team members began removing sand from the cells using the type of small shovels (Figure 3-136) used by RDFW in previous demonstrations. Sand was removed from both wing walls using shovels (Figures 3-137 and Figure 3-138). The large rental vacuum truck was then used to remove sand from the main riverside wall (Figures 3-139 and Figure 3-140). After partial removal of sand and RDFW units (Figure 3-141), a back hoe was used to remove the remainder of the bottom row (22 units) of the structure (Figure 3-142). These bottom row units were well seated in the mud. The removal of these units with the back hoe damaged the units beyond the point of being repaired. All 22 units were disposed. Overall, approximately 90 percent of the units were removed successfully, and folded and placed in crates for shipping (Figure 3-143).



Figure 3-131. Air compressor



Figure 3-132. Hand-held vacuum device (consolidated sand)



Figure 3-133. Hand-held vacuum device and water hose (saturated sand)



Figure 3-134. Sand removal from RDFW structure with water hose and compressed air



Figure 3-135. Rented vacuum truck



Figure 3-136. Shovel used to remove sand



Figure 3-137. Removing sand with shovels



Figure 3-138. Empty units



Figure 3-139. Vacuuming sand



Figure 3-140. Removal of sand from truck



Figure 3-141. RDFW units after removal



Figure 3-142. Removal with backhoe

The removal process was performed by two RDFW representatives, four government laborers, and one government equipment operator. The time required to break down and remove the structure from the site was 17.3 hr (113.4 man-hours). Once the structure was removed, the Geocell Systems' representative signed a certification that the structure was removed according to his on site directions and in accordance with Geocell Systems' removal specifications.



Figure 3-143. RDFW preparing for shipment

Reusability

Once removed, the RDFW units were inspected for damage. Some damage to the units was identified (Figure 3-144). The most damage was to the top row, bottom row, and the end units. Some individual panels of these units could be saved with the damaged pieces being replaced. Once the damaged pieces are replaced, the unit is reusable. Each RDFW unit consists of 14 pieces. Geocell Systems conducts a replacement procedure that they term “cannibalize” the units. This procedure includes the removal and replacement of damaged pieces within a unit with undamaged pieces to make the unit reusable. While minor damage was sustained during testing from the units shifting against the weight of the water, most of the damage to the RDFW units occurred during removal. Damage to the bottom units was attributed to the use of heavy machinery. By approximate field estimates, approximately 90 percent of the units were reusable.



Figure 3-144. Damaged RDFW unit

The units can be cleaned by washing the sand, mud, and debris off with a garden hose. However, they were not cleaned during this project. The used units that were not damaged or could be repaired (cannibalized) were folded flat and returned to the wooden crates. The units damaged beyond repair were disposed of.

Summary

For the field testing, various construction, removal, and performance parameters were evaluated. Table 3-8 provides a summary for the field-testing of the Rapid Deployment Flood Wall (RDFW) structure.

Even if a product performs well, the flood-fighting community is not likely to use the product unless it is cost-effective. In order to make a fair comparison of costs, each product vendor was asked to submit the cost of constructing and removing 1,000 lft of their product, 3 ft high in Vicksburg, MS. This cost included the purchase of the product plus fill material, labor, and equipment based on Vicksburg rates. The cost for shipping the products were not provided. For this cost determination, sand fill delivered to the site was estimated at \$8 per cu yd. Labor rates were \$8/hr for laborers and \$12/hr for equipment operators. Table 3-9 provides a summary of the costs furnished by Geocell Systems (RDFW). The costs provided for RDFW are based on its first time use. At the time that the costs were provided, Geocell Systems guaranteed the RDFW product for three uses. Therefore, RDFW also provided the expected costs for two subsequent uses.

Since the RDFW product was reusable, the second and third uses did not include any cost for purchase of the product. However, Geocell Systems did include a recertification fee after each of the first two uses that equals 10 percent of the initial purchase price. This fee provided for Geocell Systems to inspect and certify that each unit is reusable. All unusable pieces were replaced at no additional cost. Since the quoted purchase price for 1,000 ft of RDFW, 3 ft high was \$137,750 the recertification fee to inspect and replace damaged pieces prior to the second and third uses would be \$13,775 per use. Since that time, Geocell Systems has decided to no longer guarantee the RDFW product for reuse. Geocell Systems has no control over the amount of care in the installation and removal and over the type fill material used. Extremely rough handling of the product during installation and removal or the extraction of fill material other than sand can lead to excessive damage. However, Geocell Systems continues to claim that with proper care in the installation and removal process, the RDFW product is reusable. The field test tends to verify this claim with over 90 percent of the product used for this test certified as reusable.

| Table 3-8 RDFW Field Testing Summary | |
|---|---|
| Item | RDFW |
| ROW Used (ft) | 22 |
| Footprint Width (ft) | 6 (4-ft wide units + 2- ft wide half units) |
| Structure Length (ft) Riverward Face East Tieback West Tieback | 101 42 45.5 |
| Ease of Construction Time (hr) Effort (man-hours) Manpower (no. men) Equipment | 7.5 48.4 7 Shovels 2 Bobcat Loaders |
| Fill (cu yd) | 85 |
| Durability | The RDFW structure stayed in the field for 2 months and was subjected to hot, wet weather. The structure showed no signs of deterioration. |
| Varying Terrain | The field test site was relatively flat with a mild slope from the protected side of the RDFW structure to the riverward side. |
| Ease of Removal Time (hr) Effort (man-hours) Manpower (no. men) Equipment | 17.3 113.4 Up to 10 Hand Held Vacuums Air Compressor Shovels Pumps with Fire Hoses Vacuum Truck Track Hoe Front End Loader Forklift |
| Seepage (gal/hr) For 100 sq ft Wetted Area For 200 sq ft Wetted Area For 300 sq ft Wetted Area For 400 sq ft Wetted Area For 500 sq ft Wetted Area | 50 200 700 900 1,500 |
| Repairs | All Minor – Structural Integrity Not Threatened Added Sand Fill After Initial Sand Fill Settled |
| Reusability (percent) | Greater than 90 |

| Table 3-9 Costs For RDFW | |
|--|--|
| Item | RDFW |
| Product | 1,450 4 ft by 4 ft by 8 in. units at \$95/unit = \$137,750 290 4 ft by 2 ft by 8 in ½ units at \$47.50/unit. = \$13,775 Total product cost = \$151,525 |
| Shipping | No \$ Provided |
| Installation Laborers Operators Equipment Fill | 50 man-hours = \$400 9 man-hours = \$108 2 loader days = \$650 548 cu yd = \$4,383 |
| Removal Laborers Operators Equipment | 100 man-hours = \$800 18 man-hours = \$216 4 loader days = \$1,300 Hand tools = \$200 |
| Training by vendor for installation and removal | For initial installations only = \$10,433 No training required for subsequent installations |
| Technical support during installation and removal | Per installation = \$23,987 |

Based on the field testing, strengths and weaknesses of each product were observed. RDFW's strengths include ease of construction including time and manpower. The RDFW structure was constructed quickly and with limited effort, had low seepage rates, had a high degree of reusability, and a RDFW structure can be raised as needed by placing additional rows of units on top an existing structure. Also, the RDFW unit has the most height flexibility since the RDFW units are 8 in. high. For example, if a quantity of RDFW product was purchased to construct a wall 4 ft high and in a given flood event, only a 2-ft-high wall was required, then sufficient product would be on hand to construct a barrier twice as long as could be constructed to a height of 4 ft. For the field testing, the RDFW structure was constructed much quicker and with a much smaller labor force than the sandbag structure. The RDFW units were inspected after the field testing was completed with over 90 percent of the pieces being certified as reusable. A RDFW unit consists of 14 separate pieces. If a piece is damaged, that piece can be replaced resulting in the entire unit being reusable. RDFW's weaknesses include additional right of way required due to the placement of granular fill perpendicular to the structure by heavy machinery. Also, RDFW has a high initial cost due to the purchase price of the RDFW units (\$95 per unit). The RDFW structure was labor intensive and time consuming to remove due to the extraction of the fill sand from the 7 in. x 7 in. openings in the grid. For the field testing, the Geocell Systems representatives tried several methods for extracting the sand fill from the structure. These included hand-held vacuum devices, water hoses, compressed air, rented vacuum truck, and small garden shovels. Since the field testing was completed, Geocell Systems has been working to develop a more efficient method for removing the RDFW units after use. They have conducted tests at their office with the use of a trailer-mounted suction device. Geocell Systems has also developed a "grapppler" lifting device. This device consists of a pipe frame that supports a series of standard pallet pullers. The pallet pullers are attached to the frame and the grapppler is lifted with a front-end loader. This lifting device allows for

the removal of two grid units in a single lift. Geocell Systems plans to make the grappler lifting device available to RDFW users to assist in the removal process.

Field Installation and Performance of Portadam Barrier

Introduction

Portadam is manufactured in the United States by Portadam, Inc. of Williamstown, NJ. Portadam describes its flood-fighting product as “a steel-supporting structure with a continuous reinforced vinyl liner membrane.” The structure is free standing due to the design of the support frame that transfers the hydraulic loading to near vertical. The supporting frames are available in 3-ft, 5-ft, 7-ft, and 10-ft heights. The steel frame is assembled onsite with furnished hardware (clamps, bolts, and connecting rods). Once the frame is constructed, the impermeable liner membrane is pulled onto the steel frame and tied into place. Portadam has primarily been used for both water diversion (cofferdams) and temporary holding basins.

Field construction

For the Vicksburg Harbor field test, a 5-ft-high steel-supporting frame was used. For typical applications, Portadam pulls the liner to the top of the frame. However, the field testing protocol required each structure first to be built high enough to hold back 3 ft of water and then raised 1 ft. This requirement meant that Portadam had to manufacture a special liner for the field test. The liner consisted of a typical liner with eyelets at the top to tie it to the frame. For the field test application, Portadam attached a second, much smaller liner to the standard liner just below the eyelets to accomplish the required structure raise. This additional liner was left dangling for the initial construction to hold back 3 ft of water. For the raise, the additional liner was pulled up and tied to the top of the frame. This technique is not a standard installation practice. Portadam typically pulls the liner to the top of the frame and secures it at that height for a normal installation. This means that for a typical installation, the Portadam structure cannot be raised.

The Portadam product was delivered to the Vicksburg Harbor with two liner sections, both rolled and tied; supporting-frame members banded together in groups of approximately 20; and hardware (clamps, link bars, and bolts) in three drums (Figure 3-145). Prior to installation, the Portadam product was prepositioned adjacent to the construction site. Also, at the request of the Portadam representative, 450 sandbags were filled and delivered to the Portadam site. Portadam typically places a row of sandbags along the leading edge of their liner membrane to help provide a seal between the liner and the ground. Also, at the time the Portadam structure was constructed, the river was falling. The testing could be conducted only when the river rose to appropriate levels. Therefore, the Portadam structure had the potential of sitting in the field for an extended period of time before the river rose high enough for testing. The Portadam representative was concerned about the impacts of wind during the time when the structure would be sitting in the field with no water against it. Therefore, he requested sandbags to add weight to the structure.

Construction of the Portadam structure began during the early afternoon on 12 May in constant rain with mild temperatures. The construction crew consisted of a Portadam representative and four government laborers. None of the government laborers had any

prior knowledge of the Portadam product. The Portadam representative conducted a 5-min training session on the installation process.



Figure 3-145. Portadam as delivered to Vicksburg

Once the training session was complete, the laborers began assembling the steel supporting frame along the desired alignment. Each of the 5-ft frame members weighs approximately 28 lb. Therefore, the members were easily lifted and carried by the laborers from the staging area to the assembly location. The frame is assembled by alternately bolting the adjacent members together at the bottom and clamping the next adjacent member at the top (Figure 3-146). Also, link bars are placed in the tops of adjacent members to further strengthen the frame. This procedure creates a continuous supporting frame. In accordance with the construction protocol, about half of the site was graded to bare ground while the other half was left undisturbed with the natural grass and weeds (Figure 3-147).



Figure 3-146. Supporting frame with, bolts, clamps, and link bars (hardware)



Figure 3-147. Structure frame constructed on graded and undisturbed ground

The entire supporting frame was assembled prior to installing the liner membrane. Construction of the frame began at the free end of the east tie-back section and continued around the structure to the free end of the west tie-back section. Because the supporting frame is a continuous structure, two 90-deg turns (Figure 3-148) were required to form the u-shaped structure. The Portadam structure as constructed included a riverward face of 103 ft with the east tie-back of approximately 41 ft and the west tie-back of about 43 ft.



Figure 3-148. Making a 90-degree turn

After the frame was assembled, the two sections of liner membrane were unrolled (Figure 3-149). One section was unrolled starting from the free end of the east tie-back and the other section was unrolled from the free end of the west tie-back. The sections were connected along the riverward face of the structure with a pin-and-liner flap system (Figure 3-150). The liner membrane was then pulled by hand onto the supporting frame and tied at the 3-ft-high level (Figure 3-151). The next phase of the construction process included excavating an 8-in-deep trench around the structure along the leading edge of the liner membrane. A rented Ditch Witch was used to excavate the trench (Figure 3-152). The leading edge of the liner was placed in the trench (Figure 3-153) and buried with the soil that had been excavated from the trench (Figure 3-154). Once buried, a row of sandbags was placed along the buried edge of the liner (Figure 3-155). Burying the liner edge helps reduce the potential for seepage under the liner membrane. After the sandbags were placed, the Portadam representative inspected the structure and certified that construction of the structure to hold back 3 ft of water was completed. This construction took the Portadam representative and the four government laborers 4.5 hr (25.6 man-hours) to complete. The construction time included 0.5 hr (6.4 man-hours) to fill the sandbags used for the structure. The equipment used to construct the structure included a ratchet and socket, shovels, and the rented Ditch Witch. The only fill material needed for the Portadam structure was the sand used in the sandbags.



Figure 3-149. Unrolling liner membrane



Figure 3-150. Seam between liner membrane sections



Figure 3-151. Liner membrane tied to support frame



Figure 3-152. Excavating trench for liner leading edge



Figure 3-153. Liner leading edge placed in trench



Figure 3-154. Burying liner leading edge



Figure 3-155. Placing sandbags on liner leading edge

On the morning of 13 May, work began on the required raise to hold back 4 ft of water. The weather that morning was sunny and humid. Since the raise only included pulling up the additional liner and tying it to the frame (Figure 3-156), the Portadam representative conducted the raise without the help of any of the government laborers. The Portadam representative completed the raise in 0.6 hr (0.6 man-hours). No equipment was used to make the raise. The total time (initial structure plus the 1-ft raise) to construct the Portadam structure was 5.1 hr (26.2 man-hours).



Figure 3-156. Required Portadam raise

The 5-ft Portadam frames have a 6-ft footprint. The liner membrane for the Vicksburg Harbor test extended approximately 9 ft beyond the frame for a total footprint of 15 ft. Approximately 5 ft of additional right of way beyond the 15-ft footprint was needed to construct the structure. Total right of way required was 20 ft. If constructed on top of a levee, approximately 10 ft of right of way would be needed since the supporting frame would be constructed on the levee crown and the liner membrane would be placed down the levee slope. Figure 3-157 shows the completed Portadam structure. In accordance with the construction protocol, the Portadam representative signed a certification that the structure was constructed according to his onsite directions and according to Portadam's installation specifications.

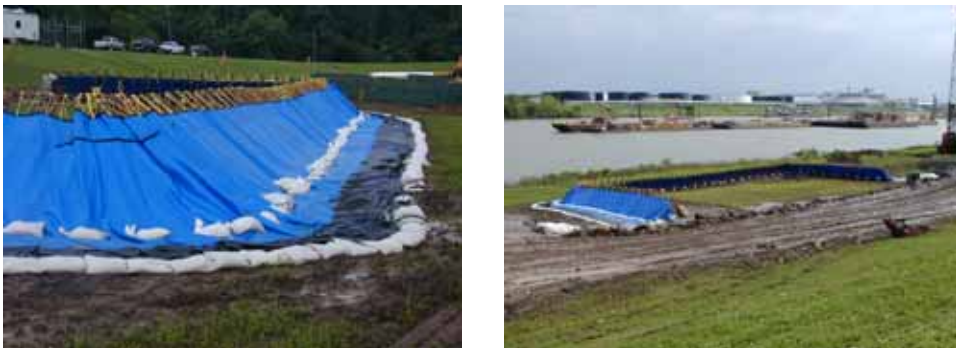

a. Riverward face

b. Protected side

Figure 3-157. Completed Portadam structure

Testing

The Portadam structure was constructed during May 2004 during a time when the river was receding. The river began to rise in early June, and by the morning of 5 June approximately 0.3 ft of water was standing against the Portadam structure. Figures 3-158 through 3-165 are a series of daily photos of the Portadam structure during the field testing. As the river continued to rise, the structure was subjected to greater static loadings. Daily water levels against the structures are given in figure captions. These water levels were determined from the 8 a.m. readings for the Mississippi River at the Vicksburg gage. Testing of the Portadam structure ended early on the morning of 11 June when the structure overtopped and flow over the structure exceeded the pump capacity on the protected side.



Figure 3-158. 4 June 2004, no water against structure



Figure 3-159. 5 June 2004, 0.3 ft of water against structure



Figure 3-160. 6 June 2004, 1.3 ft of water against structure



Figure 3-161. 7 June 2004, 2.1 ft of water against structure



Figure 3-162. 8 June 2004, 2.7 ft of water against structure



Figure 3-163. 9 June 2004, 3.1 ft of water against structure



Figure 3-164. 10 June 2004, 3.5 ft of water against structure



Figure 3-165. 11 June 2004, structure overtopped

During the field test, seepage was collected in a buried concrete tank. Seepage rates were determined by computing the change in volume in the tank over a specific time. Seepage began as soon as the river rose high enough to put water against the structure. As the water levels continued to rise, the structure experienced only limited increases in seepage. Figure 3-166 shows the Portadam structure seepage tank. The first photo was taken on 6 June 2004 with less than 1.5 ft of water against the structure. The second photo was taken on 10 June 2004 with over 3.5 ft of water against the structure. These photographs indicate that the seepage was not significantly greater on 10 June than it was on 6 June. Table 3-10 shows the seepage rate for the Portadam structure, which only gradually increased as the water levels against the structure increased. At the time that the Portadam structure overtopped, its seepage rate was the lowest of the four structures.



a. 6 June 2004



b. 10 June 2004

Figure 3-166. Portadam seepage collection tank

| Table 3-10 Field Test Seepage Rates – Portadam | |
|---|-----------------------------------|
| Wetted Surface Area of Structure (sq ft) | Seepage Rate (gal/ hr) |
| 100 | 200 |
| 200 | 300 |
| 300 | 500 |
| 400 | 550 |
| 500 | 600 |
| 600 | 600 |

During testing, no major repairs were required to the Portadam structure. However, two minor repairs and one standard preparation for overtopping were made. The minor repairs consisted of removing slack in the top of the liner membrane where the membrane was sagging. At these two locations, water began to flow over the top of the liner membrane on 10 June 2004 (Figure 3-167). The first repair included folding the top of the liner over on top of itself and holding it in place with a pair of vice grip pliers (Figure 3-168). The second repair included clamping off in the northeast 90-degree turn a section of liner with two pieces of a wooden survey stake and two c clamps (Figure 3-169). These repairs allowed for a more uniform overtopping of the structure. At the request of the Portadam representative, government laborers made the typical overtopping preparation, which consisted of placing plastic sheeting on the ground along the overtopping impact zone. This sheeting reduces the potential for erosion around the supporting frame. Figure 3-170 is a photograph of the installed plastic sheeting.



Figure 3-167. Sagging liner



Figure 3-168. Sagging liner repair (repair 1)



Figure 3-169. Sagging liner repair (repair 2)



Figure 3-170. Typical preparation for overtopping (plastic sheeting)

As the river rose, the ground around the riverward face of the supporting frame became saturated. The weight of the water on the structure pushed the supporting frame into the saturated soil approximately 4 in. (Figure 3-171). The sinking of the supporting frame increased structural stability by reducing the potential of sliding but also reduced the height of the structure. Reducing the structure height resulted in a decreased level of protection. The weight of the water also applied a significant load on the liner, especially around the corners where excess liner is located and at the connection between the two sections of liner. Though stressed, no damage to the liner was observed. Figure 3-172 shows the excess liner sagging between the supporting frame members. Figure 3-173 shows the stress on the liner seam.



a. Unsunken frame along east tieback



b. Sunken frame along riverward face

Figure 3-171. Reduced protection due to sinking of supporting frame



Figure 3-172. Sagging of liner between supporting frame members



Figure 3-173. Stressed liner seam

Early in the morning hours of 11 June 2004, the Portadam structure overtopped. By 5 a.m., the structure was overtopped at nine separate locations along the riverward face (Figure 3-174). Shortly thereafter, the pump capacity on the protected side of the structure was exceeded. At that point, the pump was removed and testing ended (Figure 3-175). Figure 3-176 is a photograph of the Portadam structure after the field testing had ended and the protected side had filled with water.



Figure 3-174. Overtopping of Portadam structure



Figure 3-175. Testing complete



Figure 3-176. Portadam structure after protected side filled with water

Removal

The crew began removing the Portadam structure on the afternoon of 19 July 2004. The weather was hot and humid with a high heat index. Due to the extreme heat, the work crew took frequent breaks. Only the time that the crew was physically working to remove the structure was included in the removal time (the clock stopped during breaks). The removal was conducted by a representative from Portadam and six government laborers. However, only four of the six government laborers worked at any one time, to allow frequent breaks and avoid heat stress.

Figure 3-177 shows the Portadam structure after the highwater receded and prior to initiating removal. The liner membrane was untied from the supporting frame and the liner was pulled off the frame (Figure 3-178). Frame disassembly (Figure 3-179 and Figure 3-180) included using a ratchet and socket to remove the clamps and bolts that held the frame members together and removing the link bars from adjacent members. The hardware (bolts, clamps, and link bars) and the frame members were hand-carried (Figure 3-181) to the staging area where the hardware was placed in drums and the frame members were wire-banded together in groups of approximately 20 members (Figure 3-182). Once the frame was disassembled, the two sections of liner were disconnected (Figure 3-183). Sandbags were removed from the liner and liner sections were pulled from the excavated trench. The liner was initially used to pull the liner from the trench by the laborers (Figure 3-184). However, since the forklift was onsite to load the product onto the trailer for transport offsite, a rope was tied around the liner and used to pull the liner from the trench with the forklift (Figure 3-185). Once removed from the trench, the liner was folded (Figure 3-186), rolled (Figure 3-187), and placed on wooden pallets (Figure 3-188). The frame members, hardware drums, and liner were loaded by the forklift onto a trailer for transport offsite (Figure 3-189). By the end of the work day (19 July), the Portadam structure had been removed (Figure 3-190). On the morning of 20 July, the sandbags were removed from the site with a front-end loader and disposed. Figure 3-191 is a photograph of the Portadam site after removal was completed. The entire removal of the Portadam structure including discarding of the sandbags required only 2.9 hr (12.6 man-hours). The tools and equipment required to remove the Portadam structure included a ratchet and socket, wire banding tool, forklift, and a front-end loader. Once the structure was removed, the Portadam representative signed a certification that the structure was removed according to his direction and in accordance with Portadam's removal specifications.



Figure 3-177. Portadam structure prior to removal



Figure 3-178. Removing liner membrane from supporting frame



Figure 3-179. Disassembling supporting frame (bolts and clamps)



Figure 3-180. Disassembling supporting frame (members)



Figure 3-181. Carrying frame members to staging area



Figure 3-182. Removal staging area

Reusability

During the removal process, the hardware, supporting frame members, and the liner membrane were inspected for damage. No visible damage was observed. Therefore, the Portadam structure used for the field testing was certified as 100 percent reusable. In fact, Portadam has historically been a rental product. They typically reuse the supporting frame members, hardware, and the liner membrane many times. However, for expedient flood-fighting, Portadam does sell their product. The field testing results indicate that the Portadam product is durable and could be reasonably expected to be reused many times. The only cleaning required for the Portadam structure includes scraping the mud off the frame members and washing the liner membrane with fresh water to remove mud, dirt, and debris. Prior to storage, the liner should be allowed to completely dry. Should the liner be ripped or torn during use, Portadam does not have a patch that can be placed in the wet. Portadam recommends repairs in the wet include placing a sheet of plywood between the torn liner and the frame on the protected side and hanging sandbags from the frame down the river face of the liner to cover the holes. Once the water has receded and the liner has dried, Portadam has two different patches for holes. One patch is glued over holes in the portion of the impermeable liner that is in contact with the frame. The other

patch is attached over holes in the fabric that is in contact with the ground beyond the frame. This patch is attached by needle and thread.



Figure 3-183. Disconnecting two sections of liner



Figure 3-184. Laborers removing liner from excavated trench



Figure 3-185. Forklift removing liner from excavated trench



Figure 3-186. Folding liner



Figure 3-187. Rolling folded liner



Figure 3-188. Liner placed on pallet



Figure 3-189. Loading Portadam frame members and hardware onto trailer



Figure 3-190. Portadam site with only sandbags remaining

Figure 3-191. Portadam site after removal complete

Summary

For the field testing, various construction, removal, and performance parameters were evaluated. Table 3-11 provides a summary for the field testing of the Portadam structure.

Even if a product performs well, the flood-fighting community is not likely to use the product unless it is cost-effective. In order to make a fair comparison of costs, each product vendor was asked to submit the cost of constructing and removing 1,000 lft of their product, 3 ft high in Vicksburg, MS. This cost included the purchase of the product plus fill material, labor, and equipment based on Vicksburg rates. The cost for shipping the products were not provided. For this cost determination, sand fill delivered to the site was estimated at \$8 per cu yd. Labor rates were \$8/hr for laborers and \$12/hr for equipment operators. Table 3-12 provides a summary of the costs furnished by Portadam. Since Portadam includes a steel frame, its cost varies with changing steel prices. The cost contained in Table 3-12 is based on November 2004 steel prices. The Portadam units are reusable. However, Portadam does not provide a guarantee that would provide for no cost replacement of damaged product.

| Table 3-11 Portadam Field Testing Summary | |
|--|--|
| Item | Portadam |
| ROW Used (ft) | 20 |
| Footprint Width (ft) | 15 |
| Structure Length (ft) Riverward Face East Tieback West Tieback | 103 41 43 |
| Ease of Construction Time (hr) Effort (man-hours) Manpower (no. men) Equipment | 5.1 26.2 5 Ratchet and socket Shovels Ditch witch |
| Fill (cu yd) | 450 sandbags |
| Durability | The Portadam structure stayed in the field for 2 months and was subjected to hot, wet weather. The structure showed no signs of deterioration. |
| Varying Terrain | The field test site was relatively flat with a mild slope from the protected side of the Portadam structure to the riverward side. |
| Ease of Removal Time (hr) Effort (man-hours) Manpower (no. men) Equipment | 2.9 12.6 5 Ratchet and socket Banding tool Front end loader Forklift |
| Seepage (gal/hr) For 100 sq ft Wetted Area For 200 sq ft Wetted Area For 300 sq ft Wetted Area For 400 sq ft Wetted Area For 500 sq ft Wetted Area For 600 sq ft Wetted Area | 200 300 500 550 600 600 |
| Repairs | All Minor – Structural integrity not threatened Raised sags in the liner |
| Reusability (percent) | 100 |

| Table 3-12 Costs For Portadam | |
|--|--|
| Item | Portadam |
| Product | \$71.30 per lft = \$71,300 |
| Shipping | No \$ provided |
| Installation Laborers Operators Equipment Fill | 8 men for 8 hr = \$512 None required Forklift and trenching machine Some sandbags |
| Removal Laborers Operators Equipment | 8 men for 8 hr = \$512 None required Forklift |
| Training by vendor for installation and removal | No cost provided |
| Technical support during installation and removal | No cost provided |

Based on the field testing, strengths and weaknesses of each product were observed. Portadam's strengths include ease of construction and removal (time, manpower, and equipment). The Portadam structure was installed much quicker and with a much smaller work force than the sandbag structure. Also, the Portadam structure was installed without the use of heavy machinery. For this field testing, the Portadam structure had low seepage rates. Being an impermeable liner with a supporting frame, Portadam required no fill except for sandbags used to help seal the leading edge of the liner and for added weight to limit wind impacts. The Portadam structure proved to have a high degree of reusability. After the field testing was completed, the Portadam structure was inspected and certified as 100 percent reusable. In fact, Portadam typically rents its product. As a rental product, the Portadam product is reused many times. Since no heavy machinery is required to construct a Portadam structure, only limited right of way is required. The weaknesses of the Portadam structure include that for a typical application, a Portadam structure cannot be raised. For the field testing, Portadam manufactured a special liner that could be tied off at 3 ft of protection and then a second flap could be pulled up and tied off for the required raise. In a typical Portadam application, the liner is pulled to the top of the supporting frame and secured there. Also, the Portadam product is not applicable for high wind use unless the structure will soon after construction have floodwater on it. A Portadam structure can also be anchored or additional weight can be applied to the structure as was the case for the field test. Sandbags were placed on the portion of the liner that extended beyond the frame and on the frame members to limit wind impacts.

4 Summary and Conclusions

Summary

Congress has recognized the need for expedient, temporary barrier type flood-fighting technologies. During 2004, Congress directed the Corps to devise real-world testing procedures for Rapid Deployment Flood Wall (RDFW) and other promising alternative flood-fighting technologies. In response, ERDC developed a comprehensive laboratory and field-testing program for the scientific evaluation of RDFW and two other alternative flood-fighting technologies. The alternative technologies, Portadam and Hesco Bastion Concertainers, were selected through a competitive process based on technical merit. A sandbag structure was also tested in both the laboratory and the field to provide a baseline by which the other products could be evaluated.

The Flood-Fighting Structures Demonstration and Evaluation Program (FFSDEP), leveraged with GI R&D research programs, provided for the modification of an existing wave test basin into a world-class test facility for the evaluation of flood-fighting products at prototype scale. A standardized protocol was developed to allow temporary flood-fighting barriers to be evaluated under a set of carefully controlled, repeatable conditions that simulate real-world conditions. During the spring and summer of 2004, the four structures were tested consecutively under identical conditions. Each product was subjected to hydrostatic testing, hydrodynamic testing with waves and overtopping, and structural debris impact testing. Also laboratory setting operational parameters including time, manpower, and equipment to construct and disassemble, suitability for construction and disassembly by unskilled labor, fill requirements, ability to construct around corners, disposal of fill material, damage, repair, reusability, and performance on a finished concrete surface were evaluated.

During May–July 2004, the field-testing was conducted in Vicksburg, MS, at the Vicksburg Harbor. The selected field site offered several advantages. The site is impacted by backwater from the Mississippi River and therefore, had a good chance of being exposed to high water during the spring and early summer. The site was located on property owned by the Vicksburg District which made the site secure with no public access. Also, the site was located adjacent to the Vicksburg District’s Mat Sinking Unit and Dredge Jadwin, which provided the required work force and heavy machinery. Protocols were developed for the field tests to include construction, testing, and removal. The protocol for the field testing included performance parameters including hydrostatic testing and hydrodynamic testing (overtopping). The field testing also included the same operational parameters that were evaluated for the laboratory testing but also included footprint and right of way requirements, durability, adaptability to varying terrain, performance on various surfaces including freshly graded and natural vegetation (grass and weeds) and ability to be raised.

Laboratory and field testing summary

For the lab and field testing, various construction, removal, and performance parameters were evaluated. Table 4-1 provides a summary of the laboratory testing. Table 4-2 provides a summary for the field testing.

Costs

Even if a product performs well, the flood-fighting community is not likely to use the product unless it is cost-effective. In order to make a fair comparison of costs, each product vendor was asked to submit the cost of constructing and removing 1,000 lft of their product, 3 ft high in Vicksburg, MS. This cost includes the purchase of the product plus fill material, labor, and equipment based on Vicksburg rates. The cost for shipping the products were not provided. For this cost determination, sand fill delivered to the site was estimated at \$8/cu yd. Labor rates were \$8/hr for laborers and \$12/hr for equipment operators. Table 4-3 provides a summary of the costs. As shown in Table 4-3, the cost for purchase of the product is far and away the primary cost in using the products. The fill material, labor, and equipment rental costs are small compared to the purchase cost of the products.

The costs contained in Table 4-3 for the sandbag structure were based on several assumptions. Those assumptions include a structure section that is 13 bags wide at the base and 2 bags wide at the crest, each sandbag adds 3 in. of height and 9 in. of length to the structure, the cost of each sandbag is \$0.25, the required volume of sand was increased by 20 percent to account for waste and spillage during filling, and the sandbag structure would be built by volunteer labor (no labor cost for construction). Since a sandbag structure is labor intensive, the cost of constructing a sandbag structure would be greatly increased if cost was included for construction of the structure.

The cost for the Portadam product varies with changing steel prices. The cost contained in Table 4-3 is based on the November 2004 steel prices for a 3-ft-high frame. While both Portadam and Hesco Bastion products have proved to be reusable, neither company provides a guarantee that would provide for no cost replacement of damaged product.

The costs provided in Table 4-3 for RDFW are based on its first time use. At the time we asked the vendors for price quotes, Geocell guaranteed the RDFW product for three uses. Therefore, Geocell also provided the expected costs for two subsequent uses. Since the product is reusable, the second and third uses did not include any cost for purchase of the product. However, Geocell Systems did include a recertification fee that was equal to 10 percent of the initial purchase price. This fee provided for Geocell to inspect and certify that each unit was reusable. All unusable pieces were replaced at no additional cost. Since the purchase price for the RDFW full size units was \$137,750, Geocell Systems would have charged \$13,775 to inspect and replace damaged pieces prior to the second and third uses. Since that time, Geocell no longer guarantees the RDFW product for reuse. Geocell has no control over the amount of care in the installation and removal and over the type fill material used. Therefore, Geocell has decided to no longer guarantee the product for reuse. However, Geocell continues to claim and the laboratory and field testing prove that with proper care in the installation and removal, much of the product can be reused at least once.

During January 2005, the Corps purchased approximately 5,000 lft of each of the three tested products. These quantities were distributed to three host Districts. Those Districts were Philadelphia, Omaha, and Sacramento. This product was used for additional field testing (pilot testing) with the remainder being stored for use during real floods by any Corps District in the host Districts' geographical region that chooses to use the products. The product costs as provided in Table 4-3 were for 3-ft-high structures. The products purchased in 2005 were for 4-ft-high structures. Furnished here is the cost for the purchased products. Three hundred thirty-six of the 4-ft-high Hesco Bastion units were purchased. Each unit was 4 ft high x 3 ft wide x 15 ft long and costs \$488. The total cost of the Hesco Bastion product was \$163,968 or \$32.53 per lft as compared to the \$26.27 vendor furnished cost for the 3-ft-high units. For Portadam, 4-ft-high frames, liner, and hardware were purchased at a total cost of \$473,595. The cost per lft was \$94.72 as compared to the vendor furnished cost of \$71.30 for the 3-ft high frames. For the RDFW, 8,700 units were purchased at a cost of \$95 per unit. The total cost of the RDFW was \$826,500 or \$162.86 per lft for a 4-ft-high structure as compared to the vendor furnished cost of \$135.71 for a 3-ft-high structure.

**Table 4-1
Laboratory Test Summary**

| Item | Portadam | Hesco Bastion | Sandbags | RDFW |
|--|--|---|--|--|
| ROW used (ft) Restricted by the facility size only | n/a | n/a | n/a | n/a |
| Footprint Width (ft) | 6 (frame) | 3 | 10 | 6 |
| Apron Width (ft) | 17 | n/a | n/a | n/a |
| Structure Length (ft) | | | | |
| Center-line Length | 68.5 | 71.5 | 80.8 | 73.4 |
| Ease of Construction | | | | |
| Time (hr) | 4.8 | 3.5 | 11.5 | 5.5 |
| Effort (man-hours) | 24.4 | 20.8 | 205.1 | 32.8 |
| Manpower (no. men) | 5 to 6 | 6 | 17 + 2 part time | 6 |
| Equipment | Ratchet and Socket Shovels | Shovels 916 Cat® Front End Loader | Sandbagger Shovels Bobcat | Shovels 2 Bobcat Loaders |
| Sand Fill (cu yd) | 250 sandbags | 25 | 52.3 | 35 |
| Durability | All products stayed in the laboratory during construction and testing with no direct sunlight and subjected only to the ambient temperature of the steel building. No deterioration was noted. | | | |
| Varying Terrain | The laboratory test products were all built on a flat surface (finished concrete floor) along the entire length of the structures. | | | |
| Ease of Removal | | | | |
| Time (hr) | 1.1 | 2.7 | 4.5 | 7 |
| Effort (man-hours) | 4.4 | 13.4 | 9 | 42 |
| Manpower (no. men) | 4 | 5 | 2 | 6 |
| Equipment | Ratchet and Socket Banding Tool Forklift | Shovels Brooms Pin Removal Bar 916 Cat® Front-end Loader | 916 Cat® Front End Loader Broom and Shovel | 2 Shop Vacuums 2 Sharp Shooter Shovels 3 Small Folding Shovels Bobcat |
| Seepage-Static Head Test | Seepage (Gallons per Minute per Foot of Structure) | | | |
| 1-ft water elevation | .095 | .390 | .047 | .021 |
| 2-ft water elevation | .135 | .935 | .230 | .076 |
| 90 and 95 percent structure height | .140 | 1.81 | .535 | .096 |
| Seepage - Dynamic Tests 66 percent Structure height water elevation | Seepage (Gallons per Minute per Foot of Structure) | | | |
| 2-in. wave height | .087 | .820 | .260 | .038 |
| 7-in. wave height | .090 | .775 | .275 | .042 |
| 11-in. wave height | .36 | .98 | 3.09 | .360 |

(Continued)

| Table 4-1 (Concluded) | | | | |
|--|--|---|--|---|
| Item | Portadam | Hesco Bastion | Sandbags | RDFW |
| Seepage - Dynamic Tests 80 percent Structure height water elevation | Seepage (Gallons per Minute per Foot of Structure) | | | |
| 2-in. wave height | .124 | 1.04 | .390 | .043 |
| 7-in. wave height | 10.72 | 1.07 | 7.42 | 4.48 |
| 11-in. wave height | 20.43 | 3.14 | 17.52 | 8.85 |
| Overtopping | Maximum Flow Over Structure + Seepage (Gallons / Minute) | | | |
| | Undulating elevation along structure 5500 | ~ Constant elevation along structure 2500 | Undulating elevation along structure 7760 | ~ Constant elevation along structure 2400 |
| Damage - Overtopping | No damage Tested 1 hour | No damage Tested 1 hour | Failed > 5 min. into test | No damage Tested 1 hour |
| Damage - Log Impact | Vinyl Tarp Puncture | No Damage | No Damage | No Damage |
| Structural Damage During Installation, Testing, and Removal | -Impermeable liner torn during debris impact | -Minor sand settling & washout -Some wire bending during debris impact | -Repeatedly damaged by waves -Failed during overtopping | -Minor sand settling - Significant washout along edges and toe -Toe damage during large waves or overtopping -10% of structure broken |
| Material Hazard | None | None | None | None |
| Repairs Minor (M) Not Threatened Failure Concern (FC) Structural Integrity | M Raise Liner bags | M Add Sandbags Place cover over the top | FC Add and Restack Sandbags | M Add Sand |
| Reusability (percent) | >99 | > 99 | 0 – All Disposed | 90 |

**Table 4-2
Field Test Summary**

| Item | Portadam | Hesco Bastion | Sandbags | RDFW |
|---------------------------|---|--|--|---|
| ROW Used (ft) | 20 | 25 | 25 | 22 |
| Footprint Width (ft) | 15 (frame + liner) | 4 (bulge in 3-foot-wide units) | 12 | 6 (4-foot- wide units + 2-ft-wide half units) |
| Structure Length (ft) | | | | |
| Riverward Face | 103 | 98 | 101 | 101 |
| East Tieback | 41 | 48 | 32 | 42 |
| West Tieback | 43 | 48 | 30 | 46 |
| Ease of Construction | | | | |
| Time (hr) | 5.1 | 8.9 | 30.5 | 7.5 |
| Effort (man-hours) | 26.2 | 57.5 | 453.1 | 48.4 |
| Manpower (no. men) | 5 | 7 | Up to 20 (fill) Up to 27 (place) | 7 |
| Equipment | Ratchet and Socket Shovels Ditch Witch | Shovels 2 Bobcat Loaders | Sandbagger Shovels Bulldozer Flat Bed Trailer | Shovels 2 Bobcat Loaders |
| Fill (cu yd) | 450 sandbags | 91 | 132 | 85 |
| Durability | All products stayed in the field for 2 months and subjected to hot, wet weather. Only the sandbag structure showed any deterioration (bags not to specs). | | | |
| Varying Terrain | The field test site was relatively flat with a mild slope from the protected side of each structure to the riverward side. | | | |
| Ease of Removal | | | | |
| Time (hr) | 2.9 | 8.7 | 2.6 | 17.3 |
| Effort (man-hours) | 12.6 | 36.3 | 3.5 | 113.4 |
| Manpower (no. men) | 5 | 6 | 2 | Up to 10 |
| Equipment | Ratchet and Socket Banding Tool Front- End Loader Forklift | Shovels Pin Removal Bar Front-End Loader Forklift | Front-End Loader Bulldozer | Hand-Held Vacuums Air Compressor Shovels Pumps with fire hose Vacuum Truck Track Hoe Front-End Loader Forklift |
| Seepage (gal/hr) | | | | |
| For 100 sq ft Wetted Area | 200 | 300 | 0 | 50 |
| For 200 sq ft Wetted Area | 300 | 2,300 | 0 | 200 |
| For 300 sq ft Wetted Area | 500 | 3,900 | 50 | 700 |
| For 400 sq ft Wetted Area | 550 | 6,000 | 300 | 900 |
| For 500 sq ft Wetted Area | 600 | --- | 800 | 1,500 |
| For 600 sq ft Wetted Area | 600 | --- | 3,200 | --- |
| Repairs | All Minor – Structural Integrity Not Threatened | | | |
| | Raise Liner Sags | Seal Joints | Add Plastic Sheeting | Add Sand |
| Reusability (percent) | 100 | > 95 | 0 – All Disposed | > 90 |

| Table 4-3 Cost for Flood-Fighting Products | | | | |
|---|--|---|--|---|
| Item | Portadam | Hesco Bastion | Sandbags | RDFW |
| Product | \$71.30 per linear foot for 3' high frames, liner, and hardware = \$71,300 | 67 3'x3'x15' units at \$394 / unit = \$26,398 | \$0.25 per bag for 120,000 bags = \$30,000 | 1450 4'x4'x8" units at \$95/unit = \$137,750 290 4'x2'x8" units at \$47.50/unit = \$13,775 |
| Total Product | \$71,300 | \$26,398 | \$30,000 | \$151,525 |
| Installation | | | | |
| Shipping | No \$ Provided | No \$ Provided | | No \$ Provided |
| Laborers | 8 men for 8 hr = \$512 | 6 men for 20 hr = \$960 | Built by volunteer labor = \$0 | 50 man- hours = \$400 |
| Operators | None required | 2 men for 20 hr = \$480 | 1 man for 40 hr = \$480 | 9 man-hours = \$108 |
| Equipment | Forklift and Trenching Machine | 2 loaders for 2 days = \$1,300 | Sandbagger provided by COE | 2 loader days = \$650 |
| Fill | Some sandbags | 425 cu yd = \$3,400 | 800 cu yd = \$6,400 | 548 cu yd = \$4,384 |
| Removal | | | | |
| Laborers | 8 men for 8 hr = \$512 | 6 men for 20 hr = \$960 | None required | 100 man-hours = \$800 |
| Operators | | 2 men for 20 hr = \$480 | 3 men for 8 hr = \$288 | 18 man-hours = \$216 |
| Equipment | Forklift | 2 loaders for 2 days = \$1,300 | 2 loaders for 1 day = \$650 2 dump trucks for 1 day = \$650 | 4 loader days = \$1,300 Hand tools - \$200 |
| Training and Technical Support | | | | |
| Training by vendor for installation and removal | No \$ Provided | No charge for initial installation | By COE or Local Sponsor Volunteers | For initial installation only = \$10,433 |
| Technical support during installation and removal | No \$ Provided | No charge for initial installation | By COE or Local Sponsor Volunteers | Per Installation = \$23,987 |

Conclusions

Based on the laboratory and field testing, strengths and weaknesses of each product relative to the sandbag structure and each other were observed. The strengths of a sandbag structure include low product cost. Sandbags also conform well to varying terrain. In both the laboratory and field tests, the sandbag structure had low seepage rates. Also, sandbag structures can be raised if needed by simply placing additional sandbags. The weaknesses of a sandbag structure are that they are labor intensive and time consuming to construct. Also, sandbags are not reusable. During the laboratory

testing, the sandbag structure was damaged during the wave impact tests and failed during the overtopping tests. The sandbags began to deteriorate during the field tests.

Portadam's strengths include ease of construction and removal (time, manpower, and equipment). The Portadam structures were constructed in less time and with a much smaller labor force than the sandbag structures. Also, the Portadam structure was constructed without the use of heavy machinery. The Portadam structure proved easy to remove. The Portadam structure had low seepage rates in both the laboratory and field tests. Portadam structures require no fill except for some sandbags that are used to help seal the leading edge of the membrane liner and to add weight to prevent wind damage. Portadam structures have a high degree of reusability. For the field test, the Portadam structure was 100 percent reusable. Since no heavy machinery is required to construct a Portadam structure, only limited right of way is required. However, Portadam does have the largest footprint of the products tested. Portadam's weaknesses include that the membrane liner punctured during the laboratory debris impact tests, a Portadam structure can't be raised in a typical application, and a Portadam structure may not be applicable for high wind use unless the structure is anchored or weighted with sandbags.

Hesco Bastion's strengths include ease of construction and removal for both time and manpower. The Hesco Bastion structures were constructed much faster and with much less labor force than the sandbag structures. The Hesco Bastion product is low cost, and a Hesco Bastion structure can be raised if required by placing a second row of units to the top of the structure. Stability can become an issue for increased height due to the narrow width of the Hesco units. If stability is an issue, a pyramid structure (two units wide on bottom row topped with a single row of units) should be constructed. Hesco Bastion units proved to have a high degree of reusability. During the laboratory and field testing, the Hesco Bastion structures suffered only minimal damage. The weaknesses of the Hesco Bastion product include the need for significant right of way due to the addition of granular fill with machinery perpendicular to the structure and high seepage rates. Since completion of the testing, Hesco Bastion has evaluated their high seepage rates. Their evaluation concluded that in both the laboratory and field testing, the Hesco Bastion units were installed incorrectly. If installed correctly, the seepage rates for a Hesco Bastion structure would be expected to be reduced.

RDFW's strengths include ease of construction for both time and manpower. In both the laboratory and field testing, the RDFW structures were constructed much faster and with a much smaller labor force than the sandbag structures. Additional strengths of the RDFW structures included low seepage rates, high degree of reusability, a RDFW structure can be raised as needed by placing additional rows of units to an existing structure, and since the RDFW units are 8 in. high, an RDFW structure provides various height options. For instance, if a user purchased a quantity of RDFW to construct a 4-ft high flood-fighting structure 1,000 ft long and in a particular flood only needed a 2-ft-high structure, then this user would have sufficient product to construct a 2,000-ft-long structure. RDFW's weaknesses include significant right of way required due to the placement of granular fill with machinery perpendicular to the structure, high cost of the product, and in both the laboratory and field testing, the RDFW structures were difficult and time consuming to remove. Since the laboratory and field testing were completed, Geocell Systems has been working to develop more efficient methods of removing the units. They have conducted tests at their office with the use of a suction trailer for extracting sand. Also, Geocell Systems has developed a "grapppler" lifting device to assist with the removal of the units. This grapppler consists of standard pallet pullers attached to a pipe frame. The grapppler is connected to two adjacent RDFW units and is

lifted with a bucket on a front-end loader. If the grappler lifting devices prove effective, Geocell Systems plans to make these devices available to RDFW users to assist in the removal process.

Both the laboratory and field testing show conclusively that a Portadam, Hesco Bastion, and RDFW structure can be constructed much faster and with much less labor force than a comparable sandbag structure. All three products performed well for most all of the testing parameters. A potential user should closely evaluate the laboratory and field testing data to determine which product or products will best meet his temporary, barrier style flood-fighting needs. The laboratory and field testing information has been placed on a publicly accessible Web site. That Web site address is <http://chl.erdc.usace.army.mil/ffs>.

References

- Clement, W. P., S. Cardimona, and K Kadinsky-Cade. 1997a. Geophysical and geotechnical site characterization data at the Groundwater Remediation Field Laboratory, Dover Air Force Base, Dover, Delaware. *Proceedings SAGEEP*, 665-673.
- Clement, W. P., S. Cardimona, A. L. Endres, and K. Kadinsky-Cade. 1997b. Site characterization data at the Groundwater Remediation Field Laboratory. *The Leading Edge* 16 (11): 1617-1621.
- Endres, A. L., and W. P. Clement. 1998. Relating cone penetrometer test information to geophysical data: A case study. *Proceedings SAGEEP*, 295-304.
- Geocell. 2004. <http://www.geocellsystems.com>.
- Hesco. 2004. <http://www.hesco-usa.com>.
- Hickin. 1974. The development of meanders in natural river channels. *American Journal of Science* 274: 414-442.
- Mississippi Department of Transportation. 2004. Port of Vicksburg. <http://www.gomdot.com/ports/VickFac.htm>.
- Olsen, R. S. 1994. *Normalization and prediction of geotechnical properties using Cone Penetrometer Test (CPT)*. Technical Report GL-94-29. Vicksburg, MS: U.S. Army Engineer Waterways Experiment Station.
- Porterdam. 2004. <http://www.portadam.com>.
- Scott, R. F., and J. J. Schoustra. 1968. *Soil mechanics and engineering*. 207-209: 213-215. New York: McGraw-Hill Co.
- Saskatchewan Highways and Transportation. Standard Test Procedures Manual, Dynamic Cone Penetrometer, Foundation Investigation. http://www.Highways.Gov.Sk.ca/docs/reports_manuals/manuals/Stp_Doc/stp240-20.pdf.
- U.S. Army Engineer District, Vicksburg. (1990, DRAFT). Yazoo Basin reformulation study, a groundwater evaluation of the Yazoo Project on the Mississippi River Valley Alluvial Aquifer.
- U.S. Army Engineer District, Vicksburg, Waterways Experiment Station, (Revised September 1979). *Geological investigation of the Yazoo Basin Lower Mississippi Valley, distribution of alluvial deposits, Vicksburg Quadrangle*, Technical Report No. 3-480, Section A-A' and B-B', Vicksburg, MS.

- Webster, S. L., R. H. Grau, and T. P. Williams. 1992. *Description of dual mass dynamic cone penetrometer*. Instruction Report IR GL-92-3. Vicksburg, MS: U.S. Army Engineer Waterways Experiment Station.
- Wyatt, D. E., M. G. Waddell, and G. B. Sexton. 1996. Geophysics and shallow faults in unconsolidated sediments. *Ground Water* 34(2): 326-334.

Appendix A Congressional Mandate and Appropriation

**MAKING APPROPRIATIONS FOR ENERGY AND WATER
DEVELOPMENT
FOR THE FISCAL YEAR ENDING SEPTEMBER
30, 2004, AND FOR OTHER PURPOSES**

CONFERENCE REPORT

TITLE I

**DEPARTMENT OF DEFENSE—CIVIL
DEPARTMENT OF THE ARMY
CORPS OF ENGINEERS—CIVIL**

FLOOD CONTROL AND COASTAL EMERGENCIES

In light of the recent replenishment of the Flood Control and Coastal Emergencies reserve fund, the conferees have provided no additional funds for this account. The recent depletion of this account, however, calls attention to two areas of concern about how this account is funded and administered. First, the drawing down of funds which could have been used to respond to actual emergency events to meet routine administrative and readiness expenses suggests that the Nation would be better served if response and readiness funds were provided and administered separately.

Second, justification provided by the Corps of Engineers suggests that those administrative and readiness expenses have grown to unacceptable levels. The Secretary is directed to consider changes in the separate management of these funds, and to report to the Appropriations Committees of the House and Senate within 180 days of enactment of this legislation into law.

The Nation deserves the best, most reliable, most economical tools which technology can provide for the protection of its citizenry and their property when confronted with natural disaster. The conferees are aware of the preliminary testing of the Rapid Deployment Flood Wall at the Engineering Research and Development Center in Vicksburg, Mississippi. This technology has shown promise in the effort to fight floods. Its proponent's claim and preliminary tests tend to confirm, that it can be cost-effective, quick to deploy, and superior to traditional sandbags in protecting property from flood damages totaling millions in dollars each year. The conferees therefore direct the Corps of Engineers, within funds available in the Flood Control and Coastal Emergencies account, to act immediately to devise real world testing procedures for this and other promising alternative flood fighting technologies, and to provide a status report to the Committees on Appropriations with 180 days of enactment of this legislation.

Appendix B

Project Management Plan

Executive Summary

Project Management Plan for Flood Fighting Structures Demonstration and Evaluation Program

Through the General Investigation Research and Development (GI R&D) Program, the U.S. Army Corps of Engineers (USACE), Engineer Research and Development Center (ERDC) has been conducting research and developing a procedure for the prototype testing of temporary flood-fighting structures intended to increase levels of protection during floods. The Rapid Deployment Flood Wall (RDFW) is one commercial product example of this type of structure. Per direction from Congress in the Energy and Water Development Bill for 2004, *“The conferees therefore direct the Corps of Engineers, within funds available in the Flood Control and Coastal Emergencies account, to act immediately to devise real world testing procedures for this and other promising alternative flood fighting technologies, and to provide a status report to the Committees on Appropriations with 180 days of enactment of this legislation.”*

A wave research basin at ERDC has been modified specifically for testing of temporary, barrier-type, flood-fighting products. Modifications to the wave basin were sponsored by GI R&D through the Technologies and Operational Innovations for Urban Watershed Networks (TOWNS) Program. GI R&D funding has also been used to develop a draft standardized protocol for prototype-scale, laboratory testing of temporary flood fighting products, although this protocol has not yet been tested. This standardized testing protocol includes both laboratory setting operational parameters (man-hours to construct and disassemble, equipment required, suitability for unskilled labor, fill requirements, ability to construct around corners, disposal of fill material), and performance parameters (hydrostatic testing, hydrodynamic testing with waves and overtopping, and structural impact testing with a floating log). A standard sandbag flood barrier will be tested through GI R&D sponsorship using the protocol to develop baseline data to which data from other types of structures may be compared.

After the baseline sandbag data has been collected in the research basin (laboratory), the current project proposes that the RDFW and two “other promising alternative flood-fighting technologies” be tested in the same facility using the standard test protocol and compared to the sandbag flood barrier baseline results. Concurrent with the research basin tests, a sandbag barrier, the RDFW, and the two alternative technologies will be tested in the field at a selected site in the Vicksburg, MS, area. The Product Delivery

Team (PDT) will approve the final selection of the field test site. Field activity will allow full-scale, real world, assessment of operational concerns such as construction of the structure on uneven or sloping ground, end effects or tiebacks, and undercutting.

The two alternate technologies to be tested will be selected from proposals received from an advertisement in the FedBizOpps Web page. Final selection of the two alternate technologies will be made by the evaluation team and then approved by the PDT based on selection criteria developed prior to placing the advertisement. The PDT includes ERDC, USACE Headquarters, Emergency Management personnel, and other representatives of the flood-fighting community from USACE District offices and levee boards. In addition to evaluation of the RDFW and two other technologies, these tests will allow an evaluation by field experts and input and advancement of the standardized testing protocol to insure that the protocol provides the best possible information to the field.

For both the laboratory and field testing, quantifiable operational data such as man-hours for construction and disassembly, special equipment requirements, and quantity of fill material will be recorded. Representatives on the PDT will evaluate the test structures for qualitative operational factors such as suitability for construction by unskilled labor, suitability for construction on sloping or uneven ground, susceptibility to end effects or undercutting, long-term durability and repairability, and reasonableness of special equipment or materials when considering use at a remote location. Susceptibility of construction materials to puncture or tear, and ability to make in-field repairs will also be considered. The ability to increase structure height by one additional foot after its initial construction will be evaluated at the field test site only. Disposal, reusability, and storage requirements of the structure and material will also be evaluated, and any previous real-world experience with the technology will be documented. This level of evaluation goes beyond the GI R&D developed protocol, but is required in order to address the "...real world testing procedures..." requirement contained within the Congressional directive.

Results of all tests will be posted on a publicly accessible Web site developed through the GI R&D program. The research basin and field tests will be conducted in FY04 at an estimated cost of \$481,500 for the research basin (laboratory) tests, \$870,500 for the field tests, plus \$123,500 for planning, coordination, and management shared by both the laboratory and field testing. An additional \$75,000 will be required for vendor reimbursement of the RDFW and the two other selected technologies. The total estimated costs of the laboratory and field test is \$1,550,500.

Point of Contact

Questions regarding the attached Project Management Plan and Standardized Testing Protocol may be directed to Dr. Donald Ward, CEERD-HC-PS, 601-634-2092, FAX 601-634-3433, e-mail Donald.L.Ward@erdc.usace.army.mil, or Dr. Johannes Wibowo, CEERD-GS-E, 601-634-4129, e-mail: Johannes.L.Wibowo@erdc.usace.army.mil. For information concerning the field tests, questions should be directed to Mr. George Sills, CEERD-GS-E, 601-634-3165, e-mail: George.L.Sills@erdc.usace.army.mil, or Mr. Fred Pinkard, CEERD-HC-R, 601-634-3086, e-mail: Fred.Pinkard@erdc.usace.army.mil.

Project Authority: Through the General Investigation Research and Development (GI R&D) Program, the U.S. Army Corps of Engineers (USACE), Engineer Research and Development Center (ERDC) has been conducting research and developing a

procedure for the prototype testing of temporary barrier type flood-fighting structures intended to increase levels of protection during floods. The Rapid Deployment Flood Wall (RDFW) is one commercial product example of this type of structure. Per direction from Congress in the Energy and Water Development Bill for 2004,

“The Nation deserves the best, most reliable, most economical tools which technology can provide for the protection of its citizenry and their property when confronted with natural disaster. The conferees are aware of the preliminary testing of the Rapid Deployment Flood Wall at the Engineering Research and Development Center in Vicksburg, Mississippi. This technology has shown promise in the effort to fight floods. Its proponent’s claim, and preliminary tests tend to confirm, that it can be cost-effective, quick to deploy, and superior to traditional sandbags in protecting property from flood damages totaling millions in dollars each year. The conferees therefore direct the Corps of Engineers, within funds available in the Flood Control and Coastal Emergencies account, to act immediately to devise real world testing procedures for this and other promising alternative flood-fighting technologies, and to provide a status report to the Committees on Appropriations with 180 days of enactment of this legislation.” (See Attachment 1)

Project Description: A wave research basin at ERDC has been modified specifically for testing of temporary, barrier style, flood-fighting products. Modifications to the wave basin were sponsored by GI R&D through the Technologies and Operational Innovations for Urban Watershed Networks (TOWNS) Program. GI R&D funding has also been used to develop a draft standardized protocol for prototype-scale, laboratory testing of temporary barrier-type flood-fighting products, although the protocol has not yet been tested. This standardized testing protocol includes both performance parameters (hydrostatic testing, hydrodynamic testing with waves and overtopping, and structural impact testing with a floating log) and laboratory setting operational parameters.

For both the laboratory and field testing, quantifiable operational data such as man-hours for construction and disassembly, special equipment requirements, and quantity of fill material will be recorded. Representatives from the PDT will evaluate the test structures for qualitative operational factors such as suitability for construction by unskilled labor, suitability for construction on sloping or uneven ground, susceptibility to end effects or undercutting, long-term durability and repairability, and reasonableness of special equipment or materials when considering use at a remote location. Susceptibility of construction materials to puncture or tear, and ability to make in-field repairs will be evaluated. The ability to increase structure height by one additional foot after its initial construction will be evaluated at the field test site only. Disposal, reusability, and storage requirements of the structure and material will also be evaluated, and any previous real-world experience with the technology will be documented. This level of evaluation goes beyond the GI R&D developed protocol, but is required in order to address the “...real world testing procedures...” requirement contained within the congressional directive.

A standard sandbag flood barrier will be tested in the research basin through GI R&D sponsorship using a modified standard test protocol to develop baseline data to which data from other types of structures may be compared. The modification to the standard test protocol includes changes to the structure alignment to allow testing of oblique angles with the wave generator.

After the baseline sandbag data have been collected in the research basin, the current project proposes testing the RDFW and two “other promising alternative flood-fighting technologies” in the same facility using the modified standard test protocol and compared

to the sandbag flood barrier baseline results. Results of all laboratory tests will be posted on a publicly accessible Web site developed through the GI R&D program, along with information on man-hours and special equipment required to construct and disassemble the flood-fighting structure, and reusability of the materials. These tests will not only evaluate the RDFW and the two other selected technologies but will allow an evaluation by field experts and input to the standardized testing protocol to insure the protocol provides the best information possible for field application.

Concurrent with the research basin experiments, the RDFW, the two other technologies, and a sandbag barrier will be constructed on a field site at Vicksburg, MS, where conditions representative of real-world conditions are expected. The four technologies will be tested at the field site concurrently. Results of the field testing will also be posted on a publicly assessable Web site. The field activity will allow a complete assessment of operational concerns such as construction of the structure on uneven or sloping ground, end effects or tiebacks, and undercutting.

To select the two “other promising alternative technologies,” an advertisement will be placed in the FedBizOpps Web page seeking proposals for products to be tested. Selection criteria will be prepared prior to placing the advertisement. Final selection of the alternative technologies will be made by the evaluation team and then approved by the study Project Delivery Team (PDT) based on selection criteria developed prior to placing the advertisement. The PDT includes members of ERDC, USACE Headquarters (HQUSACE), Emergency Management (EM) personnel, and other representatives of the flood-fighting community from USACE District offices and levee boards.

Coordination with Corps Districts: Geocell Systems, the manufacturer of RDFW, has provided a list of Corps Districts with which they have had contact concerning the use of their product. To better understand the Corps involvement with RDFW and to insure that our proposed field testing plans and site are as fair as possible to all vendors and is reasonably representative of conditions typically encountered in Corps flood-fight efforts, these Districts were contacted. The Districts include St. Paul, Nashville, Seattle, Portland, Sacramento, Los Angeles, Philadelphia, and Little Rock. Responses from the Districts varied as to their contact with Geocell. The contacts range from telephone conversations, to formal presentations, to product demonstrations, to the purchasing of RDFW, to actual installation of a section of RDFW in a flood-fight effort. Most Districts resisted purchasing or using the product to prevent the perception that the Corps of Engineers was endorsing the RDFW. Some of the Districts recommended to Geocell Systems local entities to contact about demonstrations and use of the RDFW. All the contacted Districts were interested in the proposed laboratory and field testing plans. The Districts realize that no one site will include all of the conditions (flow, duration of floods, soils, right of way limits, weather, availability of equipment and materials, etc.) that every District could encounter in a real-world flood fight. However, the contacted Districts generally concurred that the field testing plan is fair and reasonable. The Districts also concurred that the Vicksburg, MS, site is reasonably representative of real-world flood-fight conditions typically experienced by the Corps of Engineers.

Congressional Interest: Rep. Jo Ann Emerson, MO
Rep. Kenny Hulhof, MO
Rep. Todd Akin, MO
Rep. Sam Graves, MO
Rep. John T. Doolittle, CA
Rep. John Shimkus, IL
Rep. Jerry Costello, IL

Rep. Tom Latham, IA
Rep. Marion Berry, AR

Sponsor: USACE Flood Control and Coastal Emergency (FCCE) Program with leveraging from the GI R&D sponsored technical team and vendor funding of vendor's costs.

Project Delivery Team (PDT): The PDT serve for both laboratory and field testing and will include the Technical Director, Program Manager, co-Principal Investigators (PI's), engineering support staff, and ERDC representatives from Office of Counsel, Resource Management Office, and Contract Office. In addition, the PDT will include advisors from the USACE Districts including the GI R&D Program Product Selection Committee, EM personnel assigned by Headquarters, USACE (HQUSACE), and local sponsor representatives as recommended by District PDT participants (Table B1).

Scope of Project: ERDC has been directed by HQUSACE, CECW-HS to "act immediately to devise real-world testing procedures for this (note: RDFW) and other promising alternative flood-fighting technologies."

Research Basin (Laboratory) Testing. A test facility is available for testing a variety of flood-fighting structures at prototype scale, and a standard test protocol representing real-world flood levels and forces including impacts by waves and debris has been developed, but not yet tested.

The scope of work for the existing project is contingent upon completion of tests on a sandbag structure through the GI R&D's TOWNS program. Testing of the protocol and accumulation of baseline information (both operational criteria and performance parameters) from the sandbag tests are critical for the project described herein. The sandbag tests must be completed prior to testing the RDFW.

| Table B1 Project Delivery Team | |
|---|--|
| Title | Name and Affiliation |
| Technical Director | Ms. Joan Pope |
| Program Manager(s) | Dr. Kathleen White (CEERD-HC-T) Dr. Jack E. Davis, (CEERD-HC-T) |
| Principal Investigators (Laboratory) | Dr. Donald Ward, CEERD-HC-PS Dr. Johannes Wibowo (CEERD-GS-E) |
| Principal Investigators (Field) | Mr. Fred Pinkard (CEERD-HC-R) Mr. George Sills (CEERD-GS-E) |
| Geotechnical Engineer | Mr. Perry A. Taylor (CEERD-GEEB) |
| Hydraulic Engineering Technician | Mr. Thomas Murphy)CEERD-HC-PS) |
| Instrumentation Support Engineer | Mr. Thad Pratt (CEERD-HC-EM) |
| Information Technical Specialist | Mr. Terry Jobe, (CEERD-GM-A) |
| Environmental Engineer | Mr. Mike Channel (CEERD-EP-E) |
| ERDC Office of Technology Transfer and Outreach | Ms. Sharon Borland |
| HQUSACE | Mr. Jeff Jensen (CECW-HS-E) Mr. Andrew Buzewicz (CECW-HS) Mr. Leonard Kotkiewicz (CECW-HS) |
| GI R&D Program Product Selection Committee/Field Representatives to PDT | John W. Hunter (CELRN-EC-H), Chairman (currently in Iraq) Chuck Mendrop (CEMVK-ED-G), Vice-Chairman Larry Buss (CENWO-ED-H), Representative of the National Nonstructural Flood Proofing Committee Patrick Conroy (CEMVS-ED-GF) Marv Martens (CEMVR-ED-HH) Michael Ramsbotham (CESPK-ED-G) Glendon Stevens (CENAP-EC-H) Willis Walker (CESWG-EC-ES) |
| District EM Personnel | Mr. Clyde Scott (CEMVK-OD-E) Mr. Mathew Hann (CEMVS) |
| Local Sponsor | Mr. Renold Minsky, President, Fifth Louisiana Levee Board Mr. Bump Calloway, Director, Warren County (MS) Civil Defense |

The scope of research basin testing of the existing project is to use the test facility and protocol to subject the RDFW and two other “promising alternative flood-fighting technologies” to a precise and consistent series of prototype-scale experiments. The number of alternative technologies to be tested under this Project Management Plan (PMP) is dependent upon the availability of Federal FCCE funding, but a minimum of two technologies in addition to the RDFW are recommended. Reaction of the test structures, seepage rates through the structures, and operational demands of construction, operation, and demobilization will be recorded and reported on a publicly-accessible Web page, along with the corresponding baseline data collected with the sandbag tests. EM personnel from the PDT will advise on operational concerns pertinent to use of the technologies in real-world emergencies and will also provide documentation on any previous real-world experience with the technologies.

It is anticipated that the non-selected vendors will have future opportunities to have their products tested in the ERDC facility against the standard testing protocol through vendor sponsorship and a negotiated Testing Services Agreement (TSA). Such a

program is being initiated with the USACE National Non-Structural Flood Proofing Committee and the Association of State Flood Plain Managers. However, this vendor-sponsored program will not include the more rigorous level of field operational assessments proposed here and required to address the congressional directive.

Field Testing. Field testing will be conducted concurrent with the research basin testing, using the same technologies plus a sandbag barrier. Based on recommendations from the PDT, a site at Vicksburg, MS, has been selected where a real-world flooding challenge is expected. Operational criteria including ease of construction, man-hours, and special equipment requirements, use of unskilled personnel, required fill materials, and suitability to uneven or sloping terrain will be evaluated and compared to the sandbag data. The ability to increase structure height by one additional foot after its initial construction will also be evaluated. The performance of the technologies (sandbag and selected alternative technologies) will be documented, evaluated and reported. EM personnel on the PDT will assess the suitability of the technologies to other site conditions likely to be encountered in a real event (different slopes or substrate materials, different levels of site accessibility, curves or sharp corners, different hydrodynamic loadings, etc).

Planning

Selection of Test Structures

In order to comply with the language of the congressional directive a real-world evaluation of the RDFW is proposed. A minimum of two other “promising alternative flood-fighting technologies” will also be tested. Selection of the other technologies will be based on proposals received in response to an advertisement placed in the FedBizOpps Web page and using predetermined selection criteria. Selected members of the PDT will make the final selection. Background information on alternative technologies for the expedient raising of the level of flood protection works has been developed through the GI R&D Program and is contained in a database of available products.

The same technologies tested in the research basin will be tested at a preselected field location. The field site will allow room for each of the structures, including a sandbag barrier, to be constructed at the same time and subjected to the same flooding.

Testing Scenario

In the research basin tests, the products will be tested in a controlled laboratory setting, but under conditions that emulate the scenario of an impending flood overtopping a levee along a riverbank with moderate flow. The vendor will be required to arrive at the test facility with all equipment, supplies, and personnel required to erect its product prior to testing. ERDC and other members of the PDT will not assist the construction, but will observe and document the selected protocol-defined metrics associated with the construction. Selected ERDC and PDT members will observe time required to install the test wall and any special equipment requirements. ERDC and PDT participation will be funded through FCCE funds. After construction, the vendor will not be allowed to adjust the structure during any of the tests specified in the protocol. The protocol does allow the vendor access to the structure a maximum of three times between tests for a limited length of time if such access is required. Any such access to the structure will be

recorded. A delivery service contract will be signed between vendor and ERDC prior to any study and guidelines for vendor involvement and responsibilities will be delineated in this document. As all testing costs will be borne by the Government, this contract will be written in a manner that assures government ownership and responsibility for distribution of the testing results.

If, in the opinion of the PDT and pending availability of funds and time, supplementary tests are required for a specific structure to supply information deemed crucial to evaluation of the structure, these supplementary tests will be conducted in a manner that will not interfere with the standardized testing protocol. An example of a test that may be conducted in addition to the standardized testing protocol is evaluation of seepage rates on a structure with a punctured or torn seepage membrane.

Field testing of the products will be performed during the month of May 2004 with the possibility of extending into June 2004. The exact date is dependent on the Mississippi River stage at Vicksburg. Selected vendors may choose to preposition material at a Government furnished site in the Vicksburg, MS, area. Each selected vendor will be contacted and given a notice to proceed to install his barrier. Each selected vendor must have his barrier installed at the field site within five calendar days from the time he receives the notice to proceed. Each site will be provided with a marked 25-ft right of way for construction. Each barrier must be constructed within a 15-ft-wide footprint for the structure within the 25-ft right of way. Actual right-of-way used by each vendor within the provided 25-ft right of way will be measured and reported. The Government will install a large buried concrete tank inside each selected vendor's barrier to collect seepage water. Each selected vendor is required to adapt their construction to overcome any problems that might arise from the tank. The Government will prepare four separate work areas at the field test site for installation of four different temporary barrier type products. A random drawing will be conducted to determine which product is constructed on each area.

Construction

The manufacturer (or designated representatives) of each product will be responsible for construction of their product in the test facility. There are no restrictions on number of personnel that may be used. Restrictions on heavy equipment (front-end loaders, fork lifts, etc) are based only on what may safely be used at the test facility. However, total man-hours and types of equipment used will be recorded and included in the report. The vendor shall be responsible for construction and removal, transportation, and delivery of his product.

For field testing, the selected vendors will be required to furnish the appropriate quantity of their flood barrier material. Each selected vendor will also be required to install his product at the test site. Subsequent to completion of all testing, the selected vendors will also be required to remove their product. If the vendors anticipate that their product and materials are reusable, then the removal should be conducted so as to maintain the reusability of the product. The Government will monitor both the installation and removal. The field test section will be in general, a u-shaped or half box shaped structure. The test section will be placed along the channel bankline and tied back into high ground. The riverward face of the structure will be a minimum 100 ft long. The length of the tieback sections could vary depending upon the river stages at which the structures will be tested but each could be as much as 50 ft long. The Government will grade to bare ground a portion of the field test site footprint for the barrier structures

prior to installation of the selected vendors' products. The Government reserves the right to artificially wet the field-testing site prior to the selected vendor's installation of their products to best simulate possible real-world flood-fight field conditions. Each selected vendor's product must be sufficiently high to protect against 3 ft of water against the structure. The selected vendors will also be required to add one additional foot of protection during the testing as directed by the Government. Each selected vendor can use the method of his choice to achieve this additional 1-ft of protection.

Engineering

ERDC activities will include engineering support of the testing procedures, instrumentation, observation, and analysis of the structural response to the flood forces, and reporting of the results. ERDC personnel will not assist with construction or removal of the structure.

ERDC engineers and technicians will conduct the field and laboratory tests including operation and maintenance of pumps and valves, operation of the wave generator, and operation of the automated data control and processing computers and equipment. The instrumentation support technician on the PDT will assist the engineers as needed with operation and maintenance of the equipment.

Instrumentation for the laboratory tests will include a laser measurement system for determining seepage rates through the structure, laser measurements of deflection of the structure at various key locations, capacitance wave rods to measure incident wave conditions during hydrodynamic testing, and acoustic Doppler velocimeter measurements of flow rates along the structure. In addition, continuous video recordings will be made from two angles during the entire test period, plus additional video and still shots to fully document all phases of construction, disassembly, and testing.

Instrumentation for the field tests includes capacitance wave rods for measuring water elevation within the structures and external to the structures, capacitance wave rods for incident wave conditions, method for calculating seepage rates, and continuous video captures on each structure. Additional video and still shots will be used to fully document the construction and disassembly of each structure, plus the actual testing of the structures.

Non-ERDC members of the PDT will observe the tests, advise ERDC members on the appropriateness of elements of the test, and provide input to the reporting. They will also be asked to provide summary documentation on any real-world experience they may have with the technologies being tested and will assist in developing the final report.

Environmental

The environmental engineer on the PDT will issue an environmental opinion concerning use and disposal of products used in the tests. The opinion will include consideration that the product may become contaminated during exposure to floodwaters.

Communication

PDT. Communication with all members of the PDT will be maintained through conference calls, e-mails, and progress reports. After receipt of funding, a conference

call will be initiated by ERDC to insure all members are fully apprised of the PMP and testing protocol.

During research basin and field tests, selected members of the PDT will be onsite to observe all construction and disassembly of the structures and portions of all tests. In addition to ERDC engineers and technicians, onsite members of the PDT will include at least one District field person from EM, hydraulic engineering, and geotechnical engineering, and one person from a non-Corps levee board or similar non-Federal agency.

A draft letter report detailing the performance of each product tested will be sent to each member of the PDT following the completion of testing of that product. ERDC will initiate a conference call with all members of the PDT following receipt of the report to discuss results of the testing.

At the conclusion of the research basin and field tests, ERDC will initiate a conference call with all members of the PDT to discuss final results of the testing.

Additional communications will be initiated as appropriate and required.

Other. Input to status report on test program will be provided to HQUSACE by 1 May 2004. Monthly progress reports and reports on performance of each product tested will be provided to HQUSACE through the HQUSACE members of the PDT.

Safety and Occupational Health

All vendors and their crews will be required to follow guidance found in AR-385-10, The Army Safety Program, EM-385-1-1, USACE Safety and Health Requirements Manual. Specific guidelines and requirements will be included in the delivery service contract to be signed with each vendor. A complete Safety and Occupational Health Plan is being developed in conjunction with the ERDC Office of Safety.

Quality Management Plan

The quality management philosophy is to do the right things, the right way, for the right reasons, and to constantly strive for improvement. Quality will be managed through the “Plan-Do-Check-Act” cycle. This cycle will be used at both the project level and the process level.

Plan. The PDT will plan for and build quality into the work at each step in the process. A systematic planning process will be used to identify the quality goals; develop an effective plan and processes to achieve those goals, and measure the attainment of the quality objectives. It is essential that the PDT understand the costs and benefits of selected quality standards and the processes to be used to achieve the mutual objectives. The PDT will identify appropriate standards and determine how to achieve them. The PDT will consider the risk factors and complexity of the project, and adapt processes to provide the requisite level of quality.

Do. The PDT will do work according to approved plans and standard operating procedures. The actions of the PDT will be documented in sufficient detail to ensure that actions are performed correctly and completely each time. Project execution is a dynamic process. It requires the PDT to communicate and adapt to changing conditions and modify project plans to ensure project objectives are met.

Check. Sufficient independent technical review, management oversight, and verification will be performed to ensure that the quality objectives documented in the Project Management Plan are met. PDT members periodically check performance against the plan and verify sufficiency of the plan and actual performance to meet or exceed agreed-on objectives. Findings are shared with the PDT to facilitate continuous improvement.

Act. Specific corrective actions will be taken to fix the systemic cause of any nonconformance, deficiency, or other unwanted effect. Quality will be improved through systematic analysis and refinement of work processes. The process of continuous quality improvement leads to the refinement of the overall quality system. Quality improvements may include appropriate revisions to the quality management plans, alteration of procedures, or adjustments to resource allocations.

Schedule and Work Breakdown

It is anticipated that testing of the sandbag barrier under GI R&D funding will be completed in March 2004. Research basin testing of RDFW and other technologies is therefore scheduled to begin in April 2004. All laboratory testing will be completed by the end of FY 04 (Table B2). The selected vendors will be required to initiate installation of their products within 7 calendar days of being directed to do so by the Government. Also, the selected vendors will be required to remove their products within 7 calendar days of being directed to do so by the Government.

| Table B2 Field and Laboratory Testing Schedule | |
|---|---|
| Date | Accomplishments |
| March 2004 | Select alternative structures to be tested. |
| 1 April 2004 – 15 May 2004 | Install and test the RDFW in the laboratory. |
| 1 May 2004 | Provide Congressional requested status report on test program to HQUSACE. |
| 16 May 2004 – 30 June 2004 | Install and test Alternative Structure 1 (laboratory); analyze data and prepare draft letter report on RDFW laboratory tests. |
| May 2004 – Jun 2004 | Conduct field test of all four temporary flood barriers. |
| 1 July 2004 – 15 August 2004 | Install and test Alternative Structure 2 (laboratory); analyze data and prepare draft letter report on Alternative Structure 1 laboratory tests and on all field tests. |
| 16 Aug 2004 – 30 Sep 2004 | Analyze data and prepare draft letter report on Alternative Structure 2 (laboratory). |
| 1 Aug 2004 – 30 Sept 2004 | Prepare draft report for both laboratory and field testing. |
| (Activities beginning on 1 April and thereafter are contingent upon timely receipt of funding.) | |

Testing of each product is expected to require 6 weeks, including 1 week for mobilization and installation, 3 weeks for actual testing, 1 week for removal and demobilization, and 1 week for contingencies.

During the testing of each product following the RDFW, data collected during the preceding test series will be analyzed; a draft letter report will be prepared, and forwarded to HQUSACE. Data results will be posted on the GI R&D-sponsored Web site. A draft final report will be prepared within 3 months of completion of tests on the final product and submitted to HQUSACE.

The field testing will be conducted during May 2004 with the possibility of extending into June 2004. The selected vendors must be ready to initiate installation of their product on the field test site by 1 May 2004. However, the field test installation will be initiated only after it has been directed by the Government. The installation must be completed within 5 calendar days from the time that the Government notifies the selected vendors that the installation will begin. The duration of the field test is dependent upon the stages on the Mississippi River but is anticipated to last at least 2 weeks and could last up to a month or longer. The selected vendors will be required to remove their flood barrier upon direction by the Government once the testing is completed. The removal must be completed within 5 calendar days from the time that the Government notifies the selected vendors that the removal will begin.

Input for the congressionally-mandated USACE status report on the test program will be prepared and submitted to HQUSACE in May 2004 (as mandated in Attachment 1 to provide a status report within 180 days).

Cost Estimate and Funding Schedule. The total estimated costs of the laboratory and field testing is \$1,550,500. Of that total, the laboratory cost is estimated to be \$481,500. Field test cost is estimated to be \$870,500. The remaining \$198,500 includes \$75,000 for vendor costs, \$50,000 for initial planning and coordination of the laboratory and field testing PMP, and for coordination and management associated with both the laboratory and field efforts. All vendors will include in their proposals the total cost of their involvement in the research basin tests and the field tests. Vendors will be reimbursed up to a total of \$25,000 for the combined research basin and field tests, per vendor. Total vendor cost is, therefore, not to exceed \$75,000 for tests of the RDFW and two other technologies. These funds will cover the vendor's cost of furnishing their product, transporting their product to the ERDC laboratory and the field test site, and installing and removing their product from both the laboratory and field site. The laboratory costs will cover preparation of the PMP and meetings and communiqués regarding the PMP; costs of operating the test facility during the setup, testing, and cleanup of each technology; funding of offsite members of the PDT that will participate in the laboratory testing and require reimbursement for travel, per diem, salary, and reporting. The actual amount of funding required is dependent upon the size of the PDT that will participate in the laboratory testing. The field costs include the hydraulic and geotechnical efforts for coordinating, planning, conducting, and analyzing the field tests including required instrumentation, and reporting. Also, coordination between the field team and the laboratory team is included. The field testing costs also include \$95,000 for the Vicksburg District to provide labor and equipment. This \$95,000 should be funded directly to the Vicksburg District. The estimate also includes a maximum of \$25,000 for stockpiled fill materials. The actual fill material costs will be dependent upon which promising alternative flood-fight technologies are selected. The funds for stockpiled materials should be provided directly to the Vicksburg District once the technologies to be tested are selected. A cost breakdown is included in Attachment 2.

The proposed laboratory and field testing and associated reporting are required to be completed by the end of FY 04. Due to the short duration of this effort (approximately 6 months), the project funds should be made available in a timely manner. The estimated

total cost of \$1,500,500 is required by 30 April 2004. Table B3 is the required funding schedule.

| Table B3 Required Funding Schedule | | |
|---|--|---------------------|
| Date | Scheduled Work | Funding (\$) |
| 20 February 2004 | Develop PMP and initial coordination. | 50,000 |
| 17 March 2004 | Advertisement of promising technologies. Vendor contracts. Field and laboratory tests planning and coordination. | 150,000 |
| 1 April 2004 | RDFW Contract Award. Laboratory testing of DRFW. Pre-field testing site planning, coordination, and investigation including instrumentation. Selection of vendors and contract award. | 300,000 |
| 15 April 2004 | Field testing including instrumentation. | 600,000 |
| 30 April 2004 | Alternative technologies laboratory testing. Evaluation, documentation, and reporting for field and laboratory testing. | 450,500 |

Point of Contact

Questions regarding this Project Management Plan may be directed to Dr. Donald Ward, CEERD-HC-PS, 601/634-2092, FAX 601/634-3433, e-mail: Donald.L.Ward@erdc.usace.army.mil, or Dr. Johannes Wibowo, CEERD-GEEB, 601/634-4129, e-mail: Johannes.L.Wibowo@erdc.usace.army.mil. For information concerning the field tests, questions should be directed to or Mr. George Sills, CEERD-GS-E, 601/634-3165, e-mail: George.L.Sills@erdc.usace.army.mil, or Mr. Fred Pinkard, CEERD-HC-R, 601/634-3086, e-mail: Fred.Pinkard@erdc.usace.army.mil.

2 Attachments

**MAKING APPROPRIATIONS FOR ENERGY AND WATER DEVELOPMENT
FOR THE FISCAL YEAR ENDING SEPTEMBER
30, 2004, AND FOR OTHER PURPOSES**

CONFERENCE REPORT

TITLE I

DEPARTMENT OF DEFENSE—CIVIL

DEPARTMENT OF THE ARMY

CORPS OF ENGINEERS—CIVIL

FLOOD CONTROL AND COASTAL EMERGENCIES

In light of the recent replenishment of the Flood Control and Coastal Emergencies reserve fund, the conferees have provided no additional funds for this account. The recent depletion of this account, however, calls attention to two areas of concern about how this account is funded and administered. First, the drawing down of funds which could have been used to respond to actual emergency events to meet routine administrative and readiness expenses suggests that the Nation would be better served if response and readiness funds were provided and administered separately.

Second, justification provided by the Corps of Engineers suggests that those administrative and readiness expenses have grown to unacceptable levels. The Secretary is directed to consider changes in the separate management of these funds, and to report to the Appropriations Committees of the House and Senate within 180 days of enactment of this legislation into law.

The Nation deserves the best, most reliable, most economical tools which technology can provide for the protection of its citizenry and their property when confronted with natural disaster. The conferees are aware of the preliminary testing of the Rapid Deployment Flood Wall at the Engineering Research and Development Center in Vicksburg, MS. This technology has shown promise in the effort to fight floods. Its proponent's claim, and preliminary tests tend to confirm, that it can be cost-effective, quick to deploy, and superior to traditional sandbags in protecting property from flood damages totaling millions in dollars each year. The conferees therefore direct the Corps of Engineers, within funds available in the Flood Control and Coastal Emergencies account, to act immediately to devise real world testing procedures for this and other promising alternative flood fighting technologies, and to provide a status report to the Committees on Appropriations with 180 days of enactment of this legislation.

Attachment 1

Cost Breakdown

Laboratory Testing of 3 Products (RFDW + 2 other promising technologies)

| | |
|--|------------------|
| - ERDC costs for setup and testing | \$291,000 |
| - Field Representatives to be on site during testing | \$75,000 |
| - Facility Costs | \$43,500 |
| - Report/Coordination Through Committee & USACE | \$72,000 |
| Laboratory Total for 3 tests | \$481,500 |

Field Testing of 4 Products (Sand bags + RFDW + 2 other promising technologies)

| | |
|---|-----------|
| - ERDC coordination, planning, testing | \$385,000 |
| - Instrumentation | \$228,500 |
| - Field Representatives to be onsite during testing | \$50,000 |
| - Report/Coordination Through Committee & USACE | \$87,000 |
| - Vicksburg District labor and equipment | \$95,000 |
| - Stockpiled Fill Materials | \$25,000 |

Field Total for 4 tests \$870,500

Laboratory and Field Testing (RFDW + 2 other promising technologies)

| | |
|---|------------------|
| - Initial Project Planning plus Coordination and Preparation of PMP | \$50,000 |
| - Reimbursement to Vendors | \$75,000 |
| - ERDC Management and Coordination Between Field and Laboratory | \$73,500 |
| Total Shared Costs | \$198,500 |

Total Cost (Laboratory + Field + Vendor) \$1,550,500

Attachment 2

Appendix C

Laboratory Testing Protocol

STANDARDIZED TESTING PROTOCOL FOR EVALUATION OF EXPEDIENT FLOOD-FIGHT STRUCTURES

By

Dr. Johannes Wibowo, Robert Carver, Perry Taylor, and Dr. Donald Ward

1.0. Introduction

The primary purpose for developing this protocol is to test and evaluate the effectiveness of various types of expedient flood-fighting devices. Vendors of a wide range of commercial expedient structures are competing for U.S. Army Corps of Engineers emergency flood-fighting funds. These structures vary widely in form and function. For the most part, the only technical literature available on the products comes from the vendors themselves. Few vendors have tested their products at established laboratories; the majority base their performance expectations on results of their own testing. Some vendors promote products that are conceptual or in prototype development stage only. Financial decision-makers within Federal, state, and local government agencies responsible for flood-fighting are the primary targets-of-opportunity for these vendors. The fundamental problem faced by these decision-makers is that they have no basis for substantiation of the claims made by these vendors. A Standardized Testing Protocol (STP) developed, administered, and executed by the U.S. Army Engineer Research and Development Center (ERDC) laboratories is a logical and necessary tool for providing unbiased, objective technical performance data. In order to participate in the testing program, the vendors of the various products will supply funding, materials, equipment and labor to assemble their systems in accordance with the STP, and in accordance with a Testing Services Agreement (TSA) to be executed between each vendor and ERDC.

The STP focuses on configuring expedient structures as a wall or impoundment within one of the Coastal and Hydraulics Laboratory's wave basins (Attachment 1). Several key performance factors will be evaluated using STP guidelines. Structures will be subjected to hydrostatic loads, wave-induced dynamic loads, impact loads and overtopping, with the response of the structure to each test mode evaluated. Using this STP, a variety of expedient structures may be tested under the same set of controlled conditions. The results of the tests will allow the end user to determine applicability, benefits, and product performance for various situations.

2.0. Classes of Expedient Structures

The range and diversity of products used or intended for expedient flood-fighting is quite large. Products can be classified several ways. We have chosen to categorize these products into three major types:

- (a) Permanent.
- (b) Semipermanent.
- (c) Temporary.

Because of the size and high cost associated with modeling permanent and semi-permanent flood-fighting systems, only temporary flood-fighting devices will be tested under this program. The temporary structures may be further classified as:

- C-i Commercially available products that are complete flood-fighting systems in and of themselves (e.g., water-filled, air-filled, soil-and-sand-filled bladders, cells, or geotextiles; Jersey barriers; steel and concrete foldable barriers).
- C-ii Systems that are composed of readily available materials without a single sponsor marketing and selling the complete systems (e.g., sandbags, mud boxes, fabric fold-back walls, plywood or planking flashboards with or without earth backing).

It may be difficult to identify a sponsor for type “C-ii”, classified systems since no one company may market the complete systems. However, if the method is assigned a high priority by the selection committee consisting of representatives from District offices and other Federal agencies, testing will likely be performed at government expense.

3.0. Selection Criteria

At present there are a variety of products available or entering the market for expedient flood-fighting structures. The selection committee will invite and query vendors as to their interest in participation in the testing program. Time and labor constraint will not permit testing of every available product. In order to qualify for the testing the vendor should:

- (a) Provide an analytical study of the “structural integrity” of the product under flood loading. The functionality must be supported by sound engineering and physics principles. As a minimum, calculations should be provided for sliding, uplift, overturning, required tiedown configuration per unit length of structure,

and stake pullout strength. All should be calculated for static, dynamic impact and wave conditions.

- (b) Provide the cost per 100 ft of flood-fighting product, including tie downs, stakes, geotextiles, membranes, sandbags, and other associated materials as required for an in-place system of a typical height placed on soil, rock, and concrete surfaces. Include an estimate of installation man-hours required per 100 ft of flood-fight product.
- (c) Provide list of materials, tools, and construction sketch needed to build the flood-fight structure, including tiedowns or other anchors and how this will be performed in soils, concrete and asphalt concrete foundations.
- (d) Complete description of procedures for construction of the flood-fight system, with detailed information including, but not limited to, the basic unit assembly, connection of individual units, description of all anchors, tiedowns, strapping, etc., to form the complete system.
- (e) Provide accurate information to address environmental concerns for the product in the unused state, and also provide information on any environmental issues related to the product after it is used and potentially contaminated by floodwater (i.e., procedures for disposal of a potentially contaminated flood-fight structure). Explain in detail how the unit is to be taken apart and stored. If the unit is filled with a material (gas, liquid, semisolid, or solid), explain how to handle and dispose of these materials (at a minimum, Material Safety Data Sheets, as appropriate), to include procedures for disposal or treatment should they become contaminated.
- (f) Supply an adequate amount of the complete system product for model testing. Water depths ranging from approximately 2 to 3.75 ft will be used to test all flood-fighting products.
- (g) Provide consultation support during the testing of the product and provide assistance as requested by ERDC.
- (h) Agree to construct/install the candidate flood-fighting device at ERDC testing facility in Vicksburg, MS.
- (i) Assure that the structure (as constructed by the vendor or their representative in the ERDC test facility) meets the vendors' standard of construction.
- (j) Agree to accept results and allow publication by ERDC of test results.

Once the evaluation committee selects products from all the candidates, the next step will be establishment of a Cooperative Research and Development Agreement (CRADA) with each vendor.

4.0. Standardized Testing Protocol

The STP utilizes a physical model testing facility to subject the expedient flood-fighting structures to loading similar to that found in a real flood situation. One important facet of the STP is to establish a baseline of performance for comparing the effectiveness of the new products. The integrity of the new products will be evaluated against the performance of a sandbag levee built according to typical COE guidelines. The STP will include documentation of construction requirements, material costs, labor, hydraulic performance, environmentally acceptable materials, and structural integrity of the baseline case as well as each product tested.

The following elements form the basis of the STP:

- The base (floor) for the Innovative Flood-Fighting Structures (IFFS) to be tested will be constructed in the area shown in Attachment 1. Each IFFS structure will be configured as an approximately 30-ft-long levee with two additional 10-ft-long levees at each end of, and at right angles to, the 30-ft-long levee. The two 10-ft-long levees will perpendicularly abut the concrete wing walls of the testing section. The IFFS will be constructed to between 2 ft and 3.75 ft high.
- The IFFS base must fit within the construction base area. Additional membranes used for seepage reduction and occasional sandbags used as membrane hold-downs may be used in the pool area simulating the floodwater side of the IFFS. No IFFS structure parts, sandbags or membranes will be allowed inside the “off-limit” area shown in Attachment 1.
- Structures will be subjected to hydrostatic loads from incrementally increasing floodwater head, or depth.
- Structures will be subjected to hydrodynamic loads by applying waves of incrementally increasing height.
- Structures will be subjected to steady-state overtopping at 100 percent of IFFS height plus 1 in. or less, as governed by the maximum pumping capacity available to recirculate the overtopping water into the test basin.

- Structures will be subjected to a prototypical impact log test.
- Measurements of seepage and movement of IFFS will be made during all phases of the testing.
- Observations of movement of IFFS, fatigue or structural deterioration will be made during all phases of the testing.
- Up to three relatively small-scale repairs of documented damage are allowed during a test series.

5.0. Constructability Evaluation

Vendors will construct and install their own product at the ERDC test facility in Vicksburg, MS. The construction process will be recorded using a video camera. These tapes may be used later as part of Corps flood-fight training material. The first evaluation of the STP deals with issues of construction. Documentation and evaluation will be made of specific constructability issues. These issues include:

- (a) Manpower requirements.
- (b) Foundation requirements.
- (c) Material and equipment required.
- (d) Ease of construction.
- (e) Construction duration.
- (f) Special construction considerations.
- (g) Application limitations.

6.0. Hydrostatic Testing Protocol

The initial and most basic component of the STP is to evaluate the structural and hydraulic response of each IFFS to quasistatic, slowly rising hydrostatic head. The testing protocol for the hydrostatic head test will consist of flooding the basin on the riverside (or “wet” side) of the barrier or wall to the desired water level. Three water levels will be used for testing: 33-1/3 percent, 66-2/3 percent, and 95 percent of the height of the structure, also shown in Attachment 2. At each increment, the water level will be held at constant stage for a minimum of 22 hr. Continuous measurements will be made of seepages through the interface and the body of IFFS. Any observable movement of the IFFS will be documented and recorded on video. The wall will be measured for any lateral deflection at up to eight different locations as shown in Attachment 2 in order to determine whether it is sound under increasing static loading. Measurements in terms

of average volumetric quantity per unit of time will be used to calculate amounts of water flowing under or through the barrier. This will allow the engineer to determine how much water may become impounded, for a given duration, behind the wall.

7.0. Wave-induced Hydrodynamic Load Testing Protocol

The purpose of wave-induced dynamic load testing is to observe the structural response of the IFFS under hydrodynamic loading conditions. Typical hydrodynamics failures of temporary structures (Class C-i) include material failure or fatigue, fill loss, wall sliding or overturning, and deformation. The protocol specifies that packets of monochromatic waves with a wave period of $T = 2.0$ seconds be generated to impinge against the barrier. The wave tests will be conducted at two different calm water depths: 66 percent $\times h$ and 80 percent $\times h$, where h is design water depth for the structure or 3.5 ft, whichever is lower. At 66 percent $\times h$ waves of approximately 3 in. height (measured from trough to crest) will be generated continuously for a period of 7 hr. The following day waves ranging from 7 in. to 9 in. (measured from trough to crest) will be allowed to impact the structure for 30 min in 13-min increments. Afterward, the wave height will range from 10 in. to 13 in. and will be allowed to impact the structure for one 10-min increment. The water will then be brought to a level of 80 percent $\times h$ and the preceding tests will be repeated (Attachment 2). At the end of each 10-min increment of wave testing (excluding the 7 hr of 3-in. waves), the basin will be stilled for up to 45 min to allow the waves to dissipate.

The seepage observations and displacement measurement as described in Section 6.0 will also be done during hydrodynamic testing. As waves grow in height, a certain portion of the wave spills over the IFFS, depending on frontal geometry, porosity, and roughness. This quantity of water can have a significant impact on the volume of seepage.

8.0. Additional Observations and Measurements of Failing Structures During Static and Dynamic Tests

Observations and measurements of any structural damage, such as material breakage, fatigue, component failure, and an estimate fill loss will be made. Three repairs of the IFFS will be allowed during the test series as will be described in Section 11. This allows an evaluation of the expediency of the repair, method used, and integrity of the repair.

9.0. Static Overtopping

Static overtopping will be caused to occur at a riverside water level equal to 100 percent of structure height plus 1 in. (IFFS height is below 3.75 ft), and the results of the overtopping with time will be recorded and evaluated. Water level on the flood (wet) side of the IFFS will be slowly raised until the depth of flow over the structure is 1 in. (depth of water several feet out from the structure will be approximately 4 in. greater than structure height). Pumps on the dry side of the IFFS will return the water to the basin to maintain a constant head in the basin and to keep the water level on the dry side of the IFFS as low as practical. This overtopping test will proceed for 1 hr after steady state conditions are achieved or until failure occurs. If the structure floats up, the water will be raised to the appropriate elevation and the pumping will begin even though no overtopping occurs. The performance of IFFS during overtopping includes recording the movement of the structure, and observation from one or more video cameras.

10.0. Debris Impact Test

Following the overtopping test, the vendor will have the opportunity, if desired, to remove all of the water from the basins and to rebuild the IFFS to its original condition before the static, dynamic, and overtopping tests. The reconstruction procedure should be the same as the construction before static loading tests. The water level will be filled to a height of 66-2/3 percent of the height of the IFFS, and the debris impact test will be performed (Attachment 3). The purpose of this test is to evaluate the structural response of the IFFS to a simulated debris load. The IFFS will be struck with two different floating logs. A log will be pulled into the IFFS using an electric winch system to provide an impact with a velocity of 7 ft/sec, or about 5 mph. The trajectory angle between the log and the levee will be about 75 deg. Twelve-in. and 17-in. diam logs, each 12 ft long, will be used. The smaller log will be used first, followed by the bigger one. The movement and damage to the IFFS, if any, from the smaller log impact test will be observed before continuing to the larger log impact test. If the IFFS is leaking profusely or has experienced more than 6 in. permanent movement after the smaller impact log test, the bigger impact log test may not be performed. ERDC personnel will determine if it is safe to continue with the next impact log tests.

11.0. Repairs to Innovative Flood-Fight Structures

Up to a total of three minor repairs to a candidate's IFFS structure will be allowed during the three major tests (hydrostatic, hydrodynamic, and overtopping). This does not mean three repairs during each test. A minor repair is hereby defined as "a repair requiring a maximum of 30 min using a maximum of four men, using only materials available on site." There will be seven opportunities to make repairs, and the vendor can only make three repair attempts. The vendor must understand the STP completely before deciding the condition under which these three minor repairs will take place. The testing will not be halted during a particular test phase to make a repair. The repairs must all be made after the test or tests at one level is/are complete; this becomes more important during the dynamic testing, which is discussed in the following paragraphs. The three types of repairs are described as follows:

11.1. Static Test/Repair Description

During a static test, the water elevation will be raised to three different levels: 33 percent $\times h$, 66 percent $\times h$ and 95 percent $\times h$, and each level is maintained for a minimum of 22 hr while seepage, displacement, and material loss are recorded (Attachment 2). If the need for a minor repair develops at 33 percent $\times h$ or the 66 percent $\times h$, the vendor may choose whether or not to perform the minor repairs before the tests proceed to the next level. If the vendor wants to make a repair after the 95 percent $\times h$ depth, safety dictates that they must wait until the water level is dropped to the 66 percent $\times h$ level and prior to the dynamic test to make this repair.

11.2. Dynamic Test/Repair Description

During a dynamic test, the water level will be raised to an elevation corresponding to either 66 percent $\times h$ or 80 percent $\times h$. For each water elevation, three different wave magnitudes (3 in., 7 in. to 9 in., and 10 in. to 13 in.) will be allowed to impact the structure. The first wave height will run for 7 hr, followed by the second wave height for 30 min (three 10-min packets), followed by the third wave height for 10 min (one 10-min packets) (see Attachment 2). Repairs will only be allowed after first wave height is completed and after the third wave height is completed for the elevation being tested.

11.3. Overtopping Test/Repairs

There is no need to do a minor repair after the overtopping test is completed, because the levee must be repaired to its original condition preceding the log impact test. This repair is not counted as one of the three minor repairs. A maximum of 8 hr will be allowed for this repair with no limit on the number of personnel. This repair will be the responsibility of the product vendor. The method of construction should be consistent to the original method without any modification.

11.4. Review of the Three Repairs Allowed and When They May Be Performed

In summary, three minor repairs are allowed and can be performed out of seven different times of opportunity as shown in Table 1. After the overtopping test, vendor may need to do repair or rebuild if necessary for debris impact test. All of the repair materials must be onsite to make the needed repairs in and at the times specified. Repairs must be made from like materials or repair kits for the structure.

| Table C-1 IFFS Testing Matrix | | |
|--|-------------------------------------|---|
| Test | Condition | Repair Allowed |
| Hydrostatic | 33-1/3 % h, 22 hr | After 22-hr test |
| | 66-2/3 % h, 22 hr | After 22-hr test |
| | 95 % h, 22 hr | After 22-hr test, and water level lower to 66-2/3 % h |
| Hydrodynamic | 66% h, Low Wave, 7 hr | After finish of 7 hr |
| | 66 % h, Med Wave, 3 x 10 min test | After finish 66% h, High Wave Test |
| | 66 % h, High Wave, 1 x 10 min test | |
| | 80 % h, Low Wave 7 hr | After finish of 7 hr |
| | 80 % h, Med Wave, 3 x 10 min test | After finish 80% h, High Wave Test |
| | 80 % h, High Wave 1 x 10 min test | |
| Overtopping | 1 in overflow, 1 hr | Major repair or rebuild |
| Impact Debris | 12 in log, 5mph 17 in log, 5 mph | Removal of all material |

12.0. Environmental Evaluation

Material that will be used for the construction of protective barriers will be required to have an MSDS attached if it is required by the properties of the material. The MSDS will provide information as to the chemical makeup and physical properties of the material. The Environmental Laboratory (EL) will review the MSDS and determine if the material will pose any environmental risk when placed on or in the protective barrier. Also, EL will evaluate the material to determine any environmental effects the material might have if it comes in contact with certain such items as sewage, oil, debris, etc. EL will determine special handling and disposal procedures that will need to be implemented in the case that the material is released from the barrier or if it is contaminated with other material from the environment.

13.0. Evaluation Process

At the end of the test sequence, all measurement data will be compiled and presented in tables and charts. Photographs of IFFS during construction, during test, and after test will also be presented. The results obtained for the IFFS will be compared to the results obtained with sandbag tests, which are intended as a baseline performance reference. There will be no quantitative comparison of the results of tests for IFFS performance or of other IFFS products evaluated in this study. For qualitative performance evaluations (constructability and repair difficulty), the sandbag levee performance will also be used as a reference baseline. The final evaluation report will include narrative, photographs, drawings, and tables. The report will not draw conclusions, rather it will assist the field engineer in making informed decisions about the application of flood-fight products to a particular application.

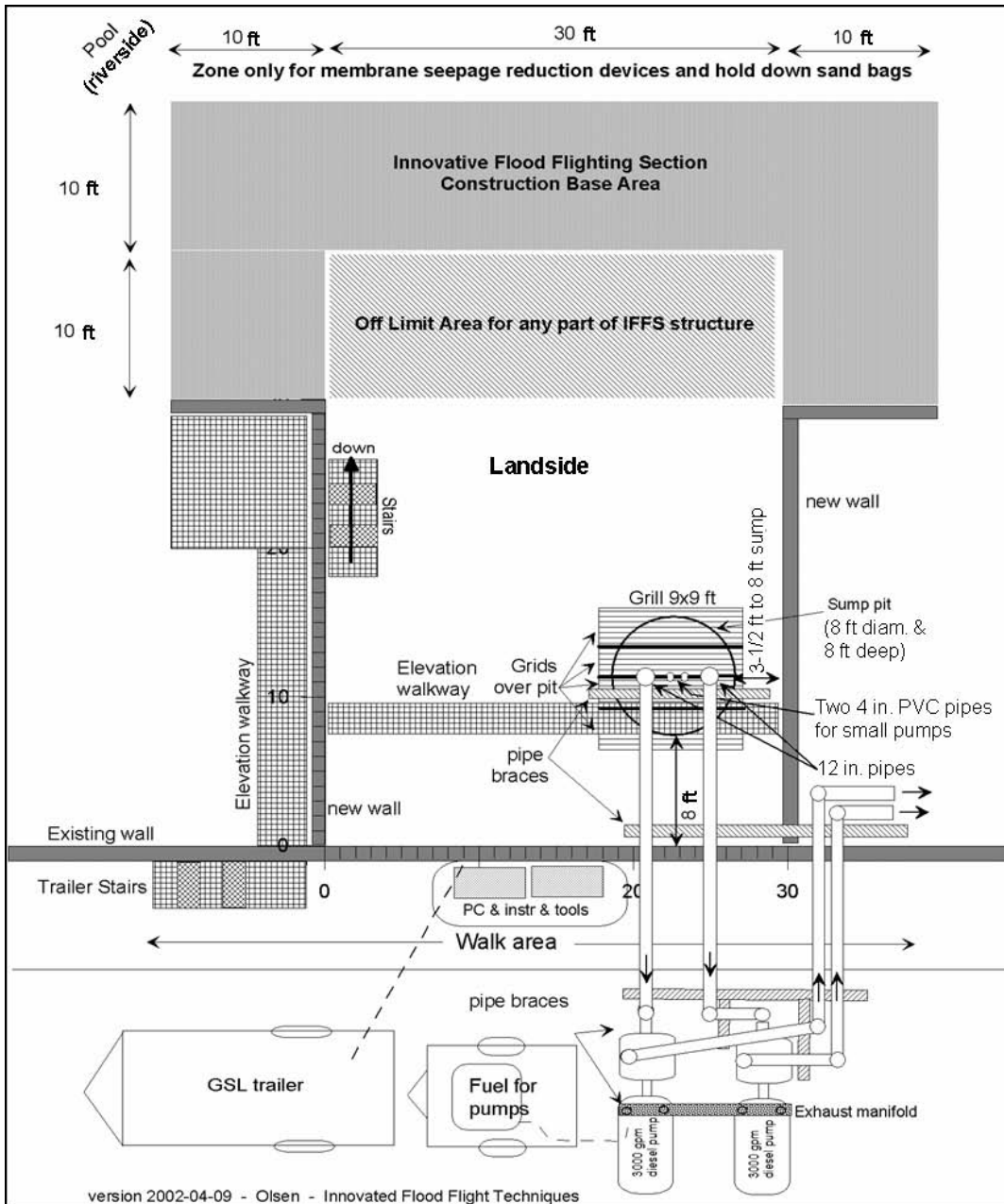

Attachment 1

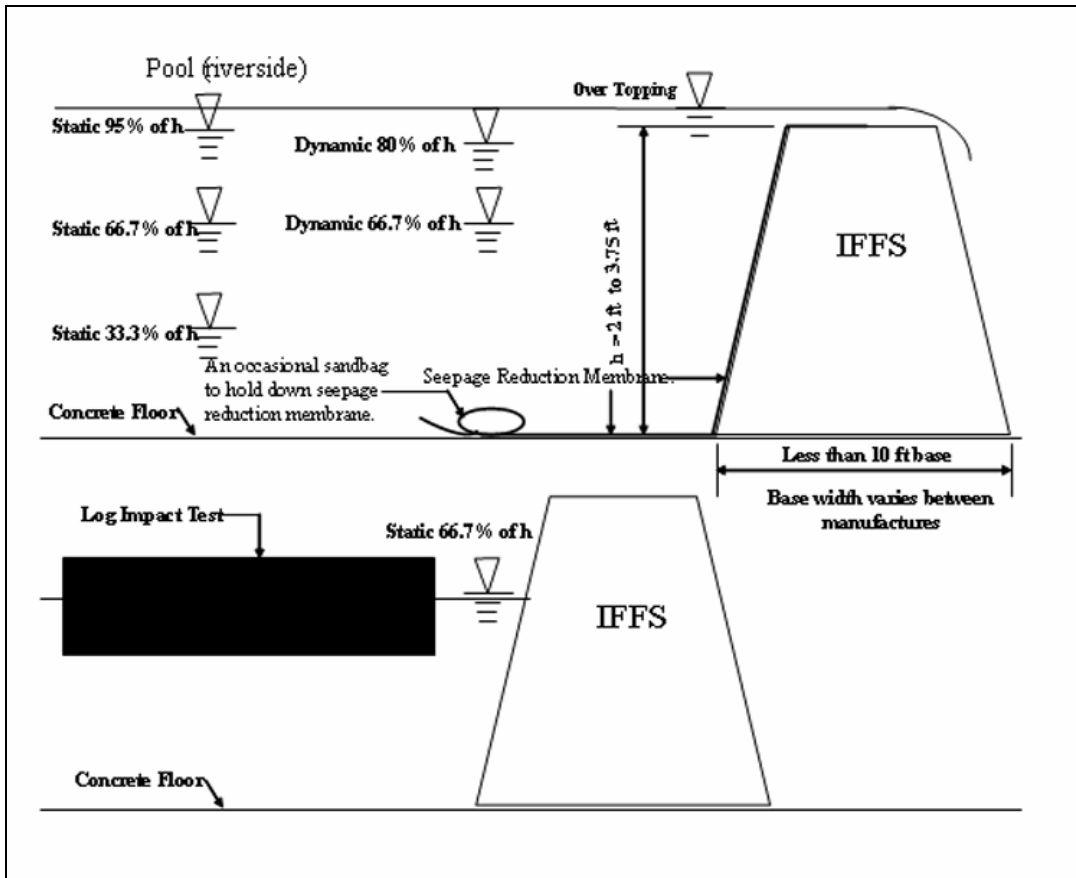

Attachment 2

Impact Tests

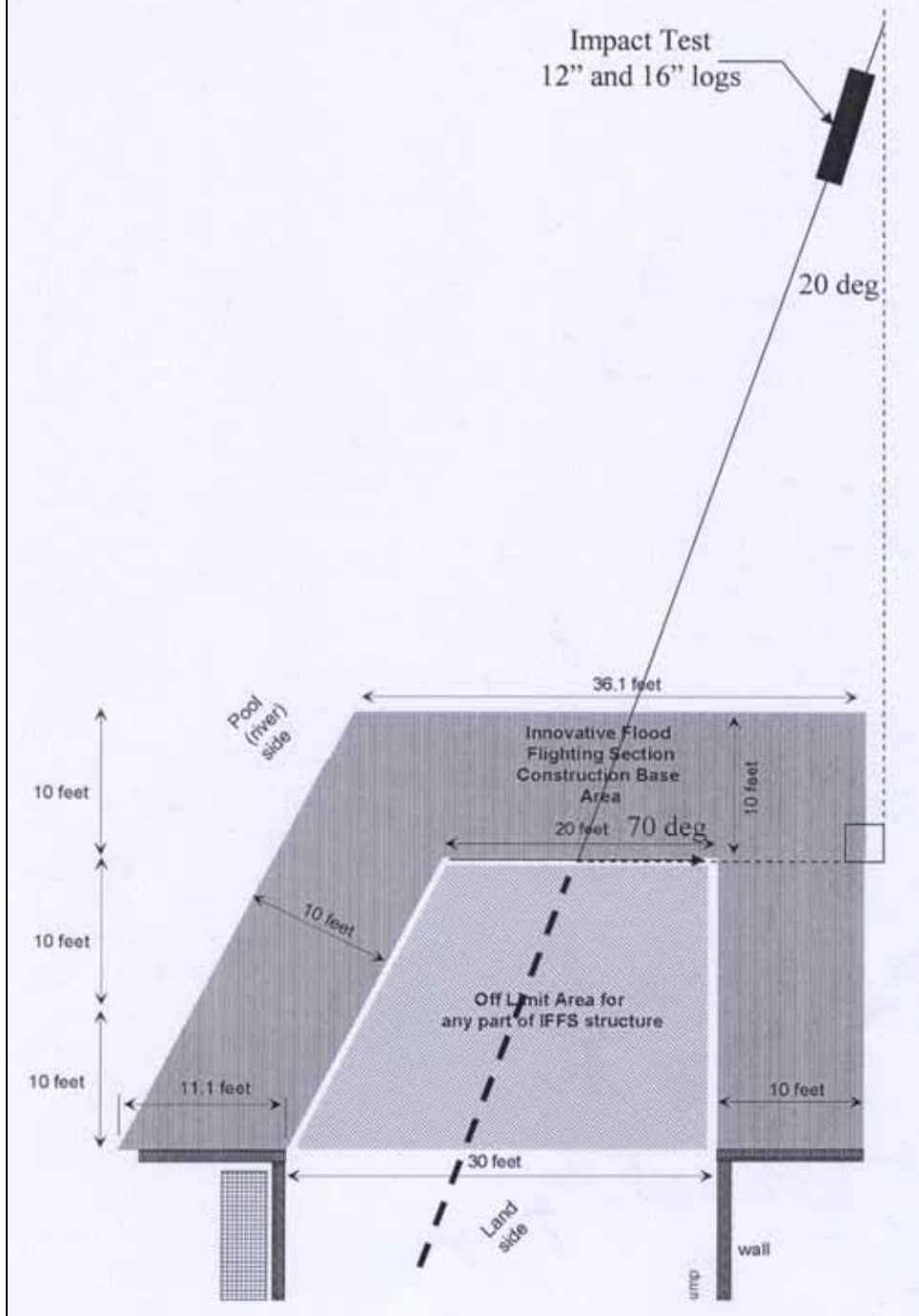

Attachment 3

REPORT DOCUMENTATION PAGE

Form Approved
OMB No. 0704-0188

Public reporting burden for this collection of information is estimated to average 1 hour per response, including the time for reviewing instructions, searching existing data sources, gathering and maintaining the data needed, and completing and reviewing this collection of information. Send comments regarding this burden estimate or any other aspect of this collection of information, including suggestions for reducing this burden to Department of Defense, Washington Headquarters Services, Directorate for Information Operations and Reports (0704-0188), 1215 Jefferson Davis Highway, Suite 1204, Arlington, VA 22202-4302. Respondents should be aware that notwithstanding any other provision of law, no person shall be subject to any penalty for failing to comply with a collection of information if it does not display a currently valid OMB control number. **PLEASE DO NOT RETURN YOUR FORM TO THE ABOVE ADDRESS.**

| | | | | | |
|--|------------------------------------|---|-----------------------------------|--|--|
| 1. REPORT DATE (DD-MM-YYYY) July 2007 | | 2. REPORT TYPE Final Report | | 3. DATES COVERED (From - To) | |
| 4. TITLE AND SUBTITLE Flood-Fighting Structures Demonstration and Evaluation Program: Laboratory and Field Testing in Vicksburg, Mississippi | | | | 5a. CONTRACT NUMBER | |
| | | | | 5b. GRANT NUMBER | |
| | | | | 5c. PROGRAM ELEMENT NUMBER | |
| 6. AUTHOR(S) Fred Pinkard, Thad Pratt, Donald Ward, Tina Holmes, Julie Kelley, Landris T. Lee, George Sills, Eric Smith, Perry A. Taylor, Nalini Torres, Lillian Wakeley, and Johannes Wibowo | | | | 5d. PROJECT NUMBER | |
| | | | | 5e. TASK NUMBER | |
| | | | | 5f. WORK UNIT NUMBER | |
| 7. PERFORMING ORGANIZATION NAME(S) AND ADDRESS(ES) U.S. Army Engineer Research and Development Center Coastal and Hydraulics Laboratory Geotechnical and Structures Laboratory 3909 Halls Ferry Road Vicksburg, MS 39180-6199 | | | | 8. PERFORMING ORGANIZATION REPORT NUMBER ERDC TR-07-3 | |
| 9. SPONSORING / MONITORING AGENCY NAME(S) AND ADDRESS(ES) Headquarters, U.S. Army Corps of Engineers Washington, DC 20314-1000 | | | | 10. SPONSOR/MONITOR'S ACRONYM(S) | |
| | | | | 11. SPONSOR/MONITOR'S REPORT NUMBER(S) | |
| 12. DISTRIBUTION / AVAILABILITY STATEMENT Approved for public release; distribution is unlimited. | | | | | |
| 13. SUPPLEMENTARY NOTES | | | | | |
| 14. ABSTRACT <p>Within the United States, sandbags have traditionally been the product of choice for temporary, barrier type flood fighting structures. However, sandbag structures are labor intensive and time consuming to construct. Therefore, a need exists for more expedient, cost effective, temporary barrier type flood-fighting technologies. In 2004, Congress directed the U.S. Army Corps of Engineers to devise real-world testing procedures for Rapid Deployment Flood Wall (RDFW) and other promising alternative flood-fighting technologies. In response to that directive, the U.S. Army Engineer Research and Development Center (ERDC) developed a comprehensive laboratory and field-testing program for RDFW and two other flood-fighting products. Those two products, Portadam and Hesco Bastion, were selected on technical merit from proposals submitted by companies who manufacture temporary, barrier type flood-fight products. A standard sandbag structure was also tested in both the laboratory and field to provide a baseline by which the other products could be evaluated.</p> <p style="text-align: right;">(Continued)</p> | | | | | |
| 15. SUBJECT TERMS Flooding Flood fighting | | Laboratory testing Field testing Sandbags | | Portadam Rapid Deployment Flood Wall (RDFW) Hesco Bastion Concertainer | |
| 16. SECURITY CLASSIFICATION OF: | | | 17. LIMITATION OF ABSTRACT | 18. NUMBER OF PAGES 344 | 19a. NAME OF RESPONSIBLE PERSON Andrew Morang |
| a. REPORT UNCLASSIFIED | b. ABSTRACT UNCLASSIFIED | c. THIS PAGE UNCLASSIFIED | | | 19b. TELEPHONE NUMBER (include area code) |

14. ABSTRACT (Continued)

During 2004, laboratory and field testing was conducted in Vicksburg, MS, under stringent testing protocols. The lab testing was conducted in a modified wave basin at ERDC. The field testing was conducted at the Vicksburg Harbor. The lab and field protocols included both performance parameters and operational parameters. These tests will provide the flood-fighting community results that will assist in the selection of the product that best fits their temporary, barrier type flood-fighting needs.